

Operating Manual PM3311(U)    Ordering number:  
9499 440 23001

Tab 1. Operating Manual  
Tab 2. Bedienungsanleitung

Tab 3. Notice d'Emploi  
PM3325 I.E.C. Bus Operating Manual

Service Manual PM3311(U)

Tab 4. Service Manual  
Tab 5. Modifications  
Tab 6. Circuit Descriptions  
Tab 7. Dismantling the Instrument  
Tab 8. Checking and Adjusting  
Tab 9. Corrective Maintenance  
Tab 10. Introduction to Microprocessors  
Tab 11. Explanation of used Symbols  
Tab 12. Parts Lists

? 67pages

Additional Diagrams

## 4. GENERAL INFORMATION

### 4.1. INTRODUCTION

The PM 3311 Digital Storage Oscilloscope is a portable, two-channel 60 MHz measuring instrument featuring micro-processor controlled electronic circuits.

A compact ergonomic design facilitates the extensive measuring capabilities of the instrument. The versatile circuit arrangement combined with the software of the micro-processor gives a wide range of facilities, including:

- Brilliant display.
- Pre-trigger view.
- Storage of two channels with four different "event" signals per channel.
- JEC-bus optional (with the aid of PM 3325).
- Plotter output.
- Trigger delay.
- Battery powered memory back-up.

Furthermore, a large 8 cm x 10 cm screen with illuminated graticule lines provides for easier viewing, a 10 kV accelerating potential giving a high-intensity trace with a well-defined spot.

The oscilloscope is provided with numerous integrated circuits, which ensure stable operation and reduce the number of adjusting points.

The supply voltage can be set to one of two ranges: 100 ... 120 V  $\pm$  10% or 220 ... 240 V  $\pm$  10%.

As a result of the features listed above, the oscilloscope is suitable for a wide range of applications, for example the measurement and observation of:

- Rise-time (gives brilliant display intensity).
- Fast signals with a very low repetition rate.
- Very low frequency signals (up to 1 hour per division)

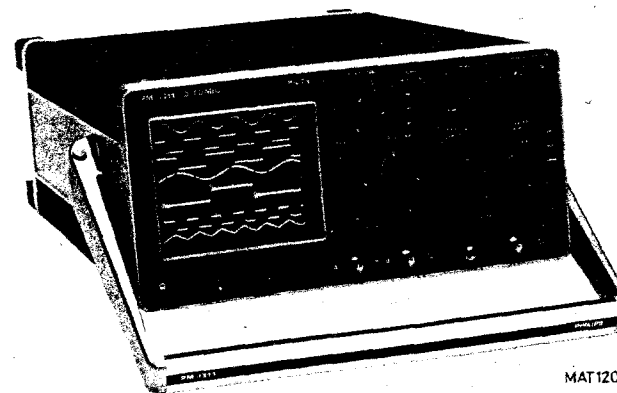

MAT1205

Fig. 4.1. 60MHz Digital storage oscilloscope PM 3311

## 4.2 CHARACTERISTICS

This instrument has been designed and tested in accordance with IEC Publication 348 for Class 1 instruments and UL 1244 and has been supplied in a safe condition. The present Instruction Manual contains information and warnings that shall be followed by the purchaser to ensure safe operation and to retain the instrument in a safe condition.

- This specification is valid after the instrument has warmed up for 30 minutes (reference temperature 23 °C).
- Properties expressed in numerical values with tolerance stated, are guaranteed by the manufacturer. Numerical values without tolerances are typical and represent the characteristics of an average instrument.
- Inaccuracies (absolute or in %) relate to the indicated reference value.

Designation	Specification	Additional information
<b>C.R.T.</b>		
Cathode ray tube	D14 - 292 GH/39	
Accelerating voltage	10 kV	Metal backed
Screen size	8 x 10 cm	
Phosphor type	P31 (GH)	
Graticule	Internal	With centimeter divisions and 2 mm subdivisions along the central vertical axis shorter 2 mm divisions along the second, fourth, sixth and eight horizontal axis.
Graticule illumination	Clearly visible under normal light conditions and continuously variable	
Trace rotation	Front panel screwdriver adjustment	
Focus	Adjusted automatically	
<b>Input vertical</b>		
Frequency range	d.c. 0 ... 60 MHz a.c. 10 Hz ... 60 MHz	
Rise-time	< 6 ns	
Pulse aberrations	± 3 %	Measured in Y-expand with a test pulse of 8 div; rise-time 1 ns; frequency 1 MHz (except first 0.2 cm measured from mid pulse)
Vertical deflection		
Defl. coeff.	10 mV/div ... 50 V/div	12 Calibrated Positions in 1-2-5 sequence
Error limit	+ 3 %	± 5 % in Y .expand
Continuous control range	1 : > 2.5	
Input impedance	1 MΩ // 25 pF	
Coupling	a.c. - 0 - d.c.	
Max. safe input voltage	400V	d.c. + a.c. peak
Input selection	A only B only Add A and B	Channel B can be inverted

C.M.R.R.	100 : 1	At 2 MHz max. common mode signal 8 div.
Dynamic range	2x voltage range	
DC offset	± 4x voltage range	
Max. sample rate	125 MHz	
Visible signal delay	> 10 ns	See also "delay"
<b>Time-base</b>		
Time coefficients		
Repetitive only	5 ns ... 0.1 μs/div	
Direct	0.2 μs ... 0.2 s/div	
Roll	0.5 s ... 60 min/div	
Coefficient error	< 2 %	4% combined with delay in "REPETITIVE ONLY"
Resolution	25 samples/div	
Triggering		
Source	A B EXT EXT : 10 Line	
Sensitivity		
Internal	0.3 div 0.15 div	at 60 MHz at 40 MHz
External	0.3 V 0.15 V	at 60 MHz at 40 MHz
Ext : 10	3 V 1.5 V	at 60 MHz at 40 MHz
Slope	+/-	
Modes	Auto d.c. a.c. TV-frame (1/1 picture)	20 Hz ... 60 MHz dc ... 60 MHz 10 Hz ... 60 MHz Acc. to CCIR 1625 lines)
Level		
Auto	Proportional to Peak-to-peak value of trigger signal	
a.c./d.c.	± 3 div	
Delay		
Range	-9 ... +9999 div 0 ... 100 div	0.2 s ... 0.5 μs/div 0.2 μs ... 5 ns/div
Accuracy	± 2 mm or 0.01 % ± 2 div + visible delay	0.2 s ... 0.5 μs/div 0.2 μs ... 5 ns/div
Input impedance	1 MΩ // 25 pF	
Max. safe input voltage	400V	dc + ac peak

Memory		
Number of memories	4	1 accumulator memory and 3 store memories
Resolution horizontal	1 : 250	In single trace mode
Resolution vertical	1 : 250	
Operation modes		
Single	Refreshment of accumulator mem takes place, when trigger level is reached and time set with trigger delay has been passed. Signal is stored according to position or trigger delay. During waiting time accumulator. is displayed and LED "NOT TRIG'D" lights UP.	0.2 μs ... 0.2 s/div
Recurrent	Signal in accumulator memory is displayed on the screen. After the time set with the trigger delay the memory is over-written by new information.	5 ns ... 0.2 s/div
Roll	Signal is built-up point by point at the right-hand side of the screen and moves to the left. When accumulator is completely filled, information is placed in register 3, next in 2, then in 1 and next in accumulator. After this, roll-mode stops, indicated by flashing "RUN" light.	0.5 s ... 60 min/div
Multiple	4 times single with "SAVE" in memories	0.2 μs ... 0.2 s/div
Display modes		
Memory	Covers 2 div. screen height	
Channel display combinations		
Accumulator	Depends on input selection	
Register	Information as stored in accumulator can be selected for storage in each of the three register memories and is displayed if display button is depressed.	Total information held in STORE 1, 2 or 3 can be inverted.
Vertical position range	± 8 div	Memory covers 10 cm screen height. Indicated via LED in display section.
Vertical expand	5 x	Continuous
Horizontal expand	1 : > 2.5	
X-Y selection	Deflection in X direction can be derived from time base or from memory contents derived from A-input	

Memory modes	Cleai	Accumulator memory is cleared
	Save (3x1)	Contents of accumulator memory are stored in selected register
	Write	Input signal can be written in accumulator memory
	Lock	Memory system is closed
	Pushbutton	Changes normal display mode (dot-join) into display of only dots.
Dot join		
1.2.8. Plot output		
Horizontal	1 V / full scale	
Vertical	1 V / full scale	
Pen lift	TTL comp.	open collector output
	"0" = unblanked (pen down)	max. load 0,5V at 500 mA conf.
	"1" = blanked (pen up)	
Max. permissible voltage	20V PEAK	
Plot time	approx. 100s.	
Plot sequence	B plot after A plot	
1.2.9. Interfaces		
IEC-Bus	Optional by means of a plug-in p.c. board	
IEC-Bur	Settings and output controllable from bus-line controller	
Local/Remote	With IEC connector.	
1.2.10. X-Y Display		
Y f(t)	From time-base	
Y f(x)	From YA input	Dot join is not in operation
Bandwidth	See YA	
Accuracy	< 5 %	Tube included
Phase difference	Distance between signal derived from A and signal derived from B is 1/25 div.	
Position	0 of stored A signal will be at centre of screen	
1.2.11. Calibration output		
Frequency	2.5 kHz	
Voltage	3 v	
Current	6 mA	
1.2.12. Power supply		
Line voltage	100 ... 120 V ± 10 % 220 ... 240 V ± 10 %	
Line frequency	50 ... 400 Hz ± 10 %	
Power consumption	< 70 W	



Battery		
Function	For memory back-up only	
Type	2 pen light batteries of 1.5 V	For instance 2 x 1.5 Philips R6P

Insulation                   The insulation of the power supply fulfils the safety requirements of IEC 348 cl. 1 for metal-encased instruments

#### Environmental characteristics

*Note:* The characteristics are valid only if the instrument is checked in accordance with the official checking procedure. Details on these procedures and failure criteria are supplied on request by the PHILIPS-organisation in your country, or by N.V. PHILIPS' GLOEILAMPENFABRIEKEN, TEST AND MEASURING DEPARTMENT, EINOHOVEN, THE NETHERLANDS.

Ambient temperature	+ 5 °C ... +40 °C -10 °C ... +40 °C -55 °C ... +75 °C	Rated range of use Operating temperature range Storage temperature in accordance with MIL 28800 and a maximum at 24 hours on high and low temperature
Altitude		
Operating	5000m (15000 ft)	In accordance with IEC 68-2-13 test M
Non-operating	15000m (50000ft)	
Humidity	Acc. IEC 68 0b	Instrument withstands 95 % RH over a temperature cycle of 25 °C to 40 °C Non-operating <sup>1</sup>
Shock	30 m/s <sup>2</sup>	Operating: half sine-wave shock of 11 ms duration; 3 shocks per direction for a total of 18 shocks.
Vibration	3 m/s <sup>2</sup>	Operating: vibrations in three directions with a maximum of 20 min. per direction; 10 minutes with a frequency of 5 · 25 Hz and amplitude of 1.016 mm p-p; 10 min with a frequency of 25 · 55 Hz and an amplitude of 0.5 mm p-p. An extra 10 minutes of the resonant of frequency with the highest rise in amplitude. Unit mounted on vibration table without shock absorbing material.
Dimensions	Length 460 mm Width 316 mm Height 154 mm	Handle and controls excluded Handle excluded Feet excluded See also Fig. 1.2.
Weight	Approx. 12kg	

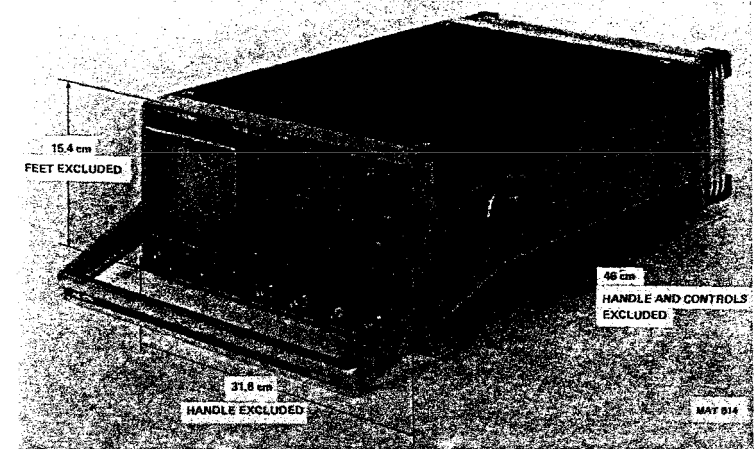

Fig. 4.2 Dimensions

←  
ch 5 BLANK

## CONTENTS

6.	CIRCUIT DESCRIPTIONS	6-5
6.1.	Blockdiagram description	6-5
6.1.1.	Acquisition	6-5
6.1.1.1.	The vertical channels	6-14
6.1.1.2.	The analog to digital converter	6-14
6.1.1.3.	Trigger and delay	6-16
6.1.1.4.	The sampling system	6-16
6.1.1.5.	The time-base system	6-17
6.1.1.6.	The acquisition control	6-17
6.1.2.	Display system	6-18
6.1.2.1.	Memories	6-18
6.1.2.2.	Dot join and plot	6-18
6.1.2.3.	Vertical final amplifier	6-19
6.1.2.4.	Horizontal final amplifier	6-19
6.1.2.5.	C.R.T. section	6-19
6.1.2.6.	Alphanumeric display	6-20
6.1.3.	Microprocessor	6-20
6.1.4.	Power supply	6-23
6.2.	Unit descriptions	6-23
6.2.1.	Front side unit A1	6-23
6.2.2.	Front unit A2	6-25
6.2.3.	Motherboard unit A3	6-44
6.2.4.	Microprocessor unit A4	6-45
6.2.5.	Spare unit A5	6-60
6.2.6.	RAM unit A6	6-61
6.2.7.	Buffer unit A7	6-72
6.2.8.	Conversion unit A8	6-82
6.2.9.	ACL unit A9	6-92
6.2.10.	CCD logic unit A10	6-110
6.2.11.	P <sup>2</sup> CCD unit A11	6-122
6.2.12.	Time-base unit A12	6-135
6.2.13.	Delay trigger unit A13	6-147
6.2.14.	IEC unit A14	6-156
6.2.15.	DC power unit A15	6-157
6.2.16.	AC power unit A16	6-166
6.2.17.	Rear side unit A17	6-174
6.2.18.	Delay line unit A18	6-175
6.2.19.	CRT socket A19	6-176
6.2.20.	Final ampl. unit A20	6-178
6.2.21.	Amplifier unit A21	6-188
6.2.22.	Trigger unit A22	6-211
6.2.23.	EHT unit A23	6-231
6.2.24.	Driver unit A34	6-232

6-2

7.	DISMANTLING THE INSTRUMENT	7-1
7.1.	Warnings	7-1
7.2.	Removing the covers	7-2
7.3.	Access to parts for checking and adjusting procedure	7-3
8	CHECKING AND ADJUSTING	8-1
8.1.	General information	8-1
8.1.1.	Recommended test equipment	8-2
8.1.2.	Preliminary settings	8-3
8.2.	Survey of adjusting elements	8-4
8.3.	Checking and adjusting procedure	8-8
8.3.1.	Power supply	8-8
8.3.2.	Cathode-ray tube circuit	8-9
8.3.3.	Pre adjustment P <sup>2</sup> CCD circuit	8-12
8.3.4.	Balance adjustments	8-13
8.3.5.	Final amplifier adjustments	8-15
8.3.6.	Vertical channels	8-17
8.3.7.	Time coefficient adjustments	8-20
8.3.8.	Triggering	8-21
8.3.9.	X-Y mode	8-24
8.3.10.	Range indication	8-24
8.3.11.	Plotter outputs	8-24
8.3.12.	Periodic and random deviations	8-24
8.3.13.	Effect of mains voltage variations	8-24
8.4.	Interactions	8-25
8.5.	Performance check	8-29
9	CORRECTIVE MAINTENANCE	9-1
9.1.	Replacements	9-1
9.1.1.	Replacing single knobs	9-1
9.1.2.	Replacing double knobs	9-1
9.1.3.	Replacing carrying handle	9-2
9.1.4.	Removing the cabinet plates and the screen bezel	9-3
9.1.5.	Replacing the plug-in units	9-4
9.1.6.	Replacing the P <sup>2</sup> CCD unit A11	9-5
9.1.7.	Replacing the front unit A2	9-5
9.1.8.	Replacing the LEVEL control	9-7
9.1.9.	Replacing the trigger mode switch	9-7
9.1.10.	Replacing the C.R.T.	9-7
9.1.11.	Replacing the delay line unit A18	9-8
9.1.12.	Removing the rear plate together with the AC POWER UNIT A16	9-8
9.1.13.	Removing the DC POWER UNIT A15	9-8
9.1.14.	Removing the mains filter	9-8
9.1.15.	Removing the EHT unit A23	9-8
9.1.16.	Removing the vertical amplifier unit A21	9-8
9.1.17.	Removing the trigger unit A22	4-8
9.2.	Soldering techniques	9-9
9.3.	Handling MOS devices	9-10
9.4.	Special tools	9-11
9.5.	Recalibration after repair	412
9.6.	Instrument repackaging	9-12
9.7.	Trouble shooting	9-13

9.7.1.	Introduction	9-13
9.7.2.	Power-up routine	9-13
9.7.3.	Trouble shooting aids	9-15
9.7.4.	Service faultfinding software routines	9-15
9.7.5.	Trouble shooting <b>hints</b>	
9.7.6.	Overall view of provisions and service methods	9-20
9.7.7.	Mains voltage setting	9-26
10.	INTRODUCTION TO MICROPROCESSOR'S	10-1
10.1.	A brief encounter	10-1
10.2.	Coming to terms	10-1
10.3.	System features	10-4
11.	EXPLANATION OF USED SYMBOLS	11-1
12.	PARTS LISTS (Subject to alteration without notice)	12-1
12.1.	Mechanical parts	12-2
12.2.	Electrical parts	12-8
13.	ADDITIONAL DIAGRAMS	13-2

## 6. CIRCUIT DESCRIPTIONS

### 6.1. BLOCK DIAGRAM DESCRIPTION

This chapter serves to explain the main functions of the oscilloscope. The working principle is divided into four sections

- 6.1.1. Acquisition system
- 6.1.2. Display system
- 6.1.3. Microprocessor and software
- 6.1.4. Power supply

#### 6.1.1. Acquisition system

By means of the acquisition system the analog input signals are converted into digital information. Before conversion the analog signals must be adapted so that an Analog to Digital Converter (ADC) is able to convert them. This system can be divided into the following sections:

- 6.1.1.1. The vertical channels
- 6.1.1.2. The analog to digital converter (including P2CCD)
- 6.1.1.3. Trigger and trigger delay circuits
- 6.1.1.4. The sampling system
- 6.1.1.5. The time base system
- 6.1.1.6. The acquisition control

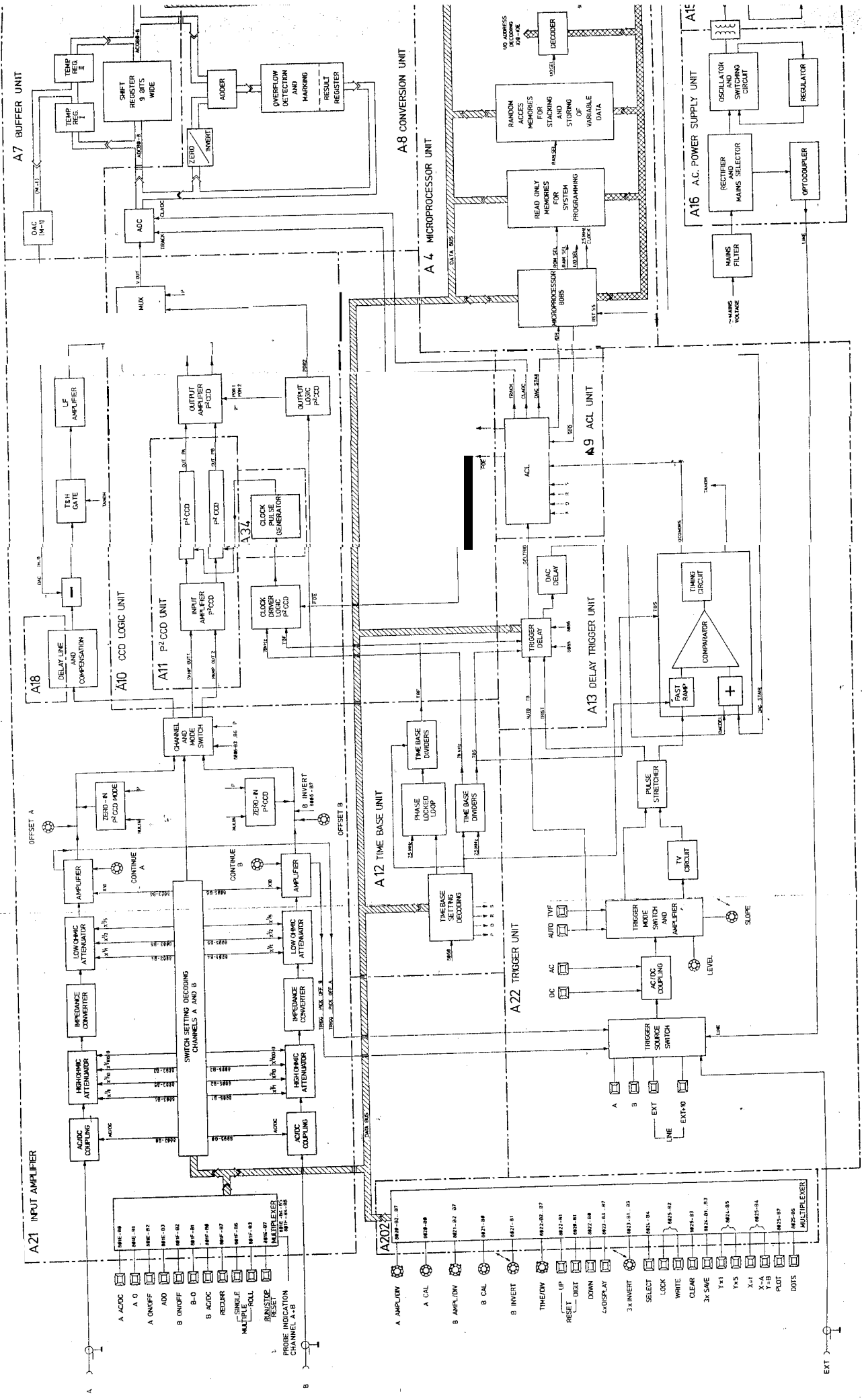
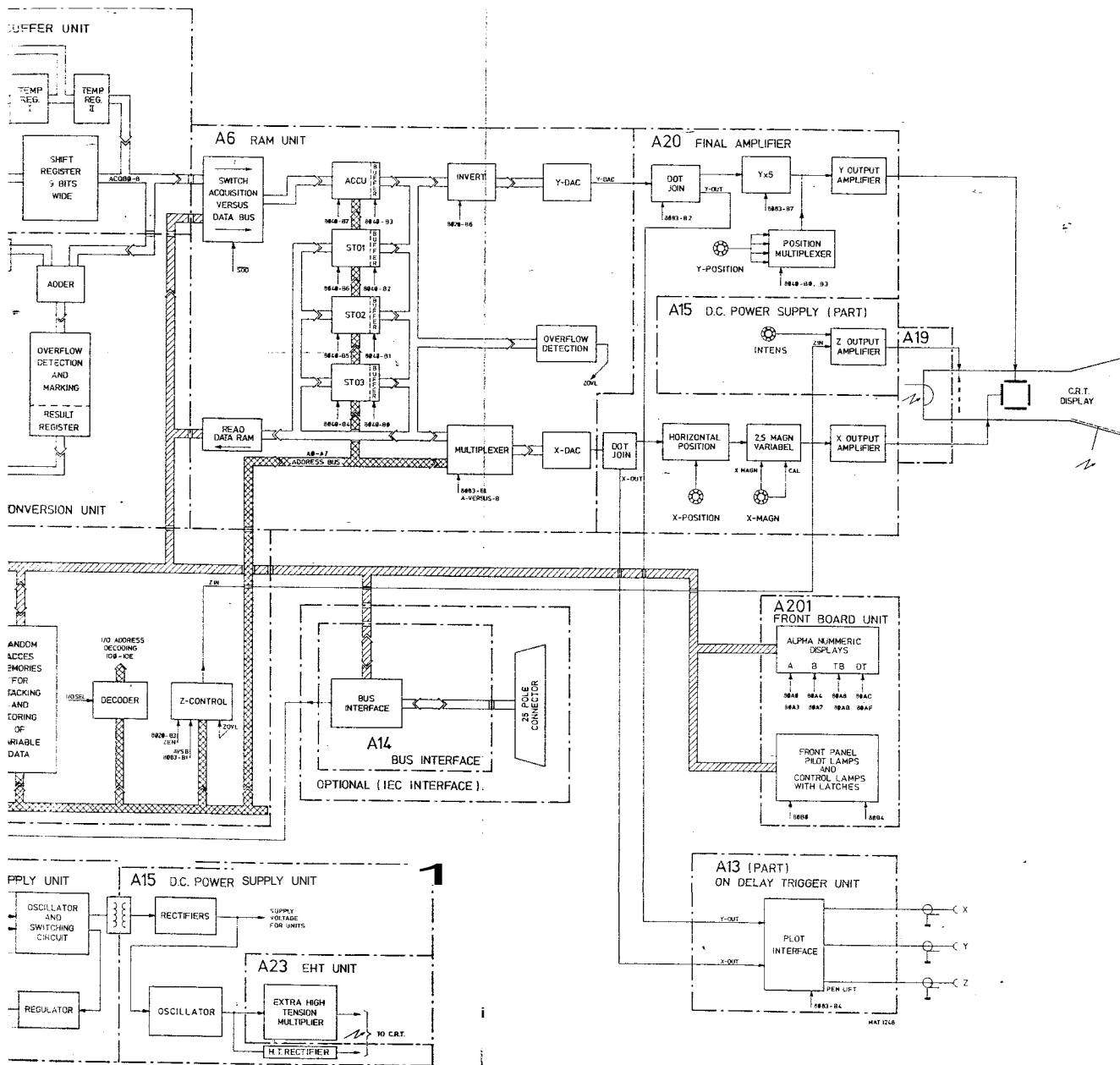

Fig. 6.1.1.



6.1.1.1. The vertical channels (unit A21 page 6-188)

The vertical channel consist of two identical channels A and B except for the possibility E  
 - The sensitivity range is 10 mV/div ... 50 V/div in a 1-2-5 sequence.  
 All front panel settings of the vertical channels except for the CONTINUE AN OFFSET co  
 main loop of the program of the microprocessor system via multiplexers.  
 After calculation in the microprocessor, the settings are written into the switch setting de  
 generates the signals to set the ac/dc coupling, the-high and low ohmic attenuators and th  
 according to the front panel settings. Moreover these settings can be determined by the IE  
 ?he input signal is applied to the channel switch via the ac/dc coupling, the high ohmic at  
 convertor, the low ohmic attenuator and the amplifier.  
 Just after the amplifier a zero in signal NULIN for P<sup>2</sup>CCD-mode operation is applied to th  
 For time base settings of 3600 s/div, 0.5ms/div - and 0.2 μs/div - 5 ns/div the channe  
 signal to the delay line.

In dual channel mode (A and B) the microprocessor system generates via the switch setting  
 A ON and B ON in such a way, that a chopped signal is applied to the delay line. The outp  
 is connected to a compensation network to correct the faults introduced by the delay line

6.1.1.2. The analog-to-digital convertor (including P<sup>2</sup>CCD) (units A7 + A10 + A11 + A34 page

The output signal of the delay line is applied to the T&H (Track and Hold) gate via a subtr  
 This T&H gate tracks the input signal continuously and at a command TANDH its output  
 momentary value of the input signal for about 4 μseconds. The signal TANDH is generate  
 and will be described later. Via a low frequency amplifier and a multiplexer the output sig  
 is applied to the sample and hold gate of an ADC in which the output signal of the T&H g  
 held to the same value for at least the conversion time.

The ADC is controlled by the signals TRACK and CLADC which are generated at the Acc  
 Logic A9 (ACL).

To eliminate faults of the ADC conversion a correction takes place.

In ROLL, DIRECT and SAMPLING (see operating manual and chapter 6.1.1.6.) mode the  
 as follows:

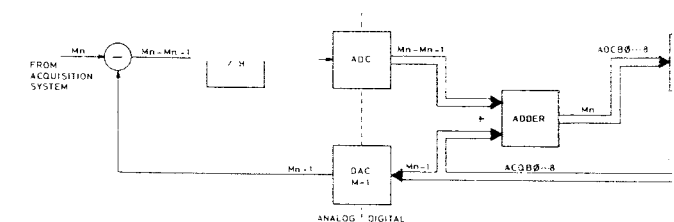

Fig. 6.1.2.

6-14

### 6.1.1.1. The vertical channels (unit A21 page 6-188)

The vertical channel consist of two identical channels A and B except for the possibility B invert. The sensitivity range is 10mV/div ... 50 V/div in a 1-2-5 sequence. All front panel settings of the vertical channels except for the CONTINUE an OFFSET controls are read each main loop of the program of the microprocessor system via multiplexers. After calculation in the microprocessor, the settings are written into the switch setting decoding. This decoding generates the signals to set the ac/dc coupling, the high and low ohmic attenuators and the amplifier gain according to the front panel settings. Moreover these settings can be determined by the IEC Bus interface option. The input signal is applied to the channel switch via the ac/dc coupling, the high ohmic attenuator, the impedance convertor, the low ohmic attenuator and the amplifier. Just after the amplifier a zero in signal NULIN for P<sup>2</sup>CCD-mode operation is applied to the channel switch. For time base settings of 3600 s/div, 0.5ms/div - and 0.2 μs/div - 5 ns/div the channel switch connects the signal to the delay line. In dual channel mode (A and B) the microprocessor system generates via the switch setting decoding the signals A DN and B ON IN such a way, that a chopped signal is applied to the delay line. The output of the delay line is connected to a compensation network to correct the faults introduced by the delay line.

### 6.1.1.2. The analog-to-digital convertor (including P<sup>2</sup>CCD) (units A7 + A10 + A11 + A34 page 6-72/110/122/232).

The output signal of the delay line is applied to the T&H (Track and Hold) gate via a subtractor. This T&H gate tracks the input signal continuously and at a command TANDH its output is held to the momentary value of the input signal for about 4 μseconds. The signal TANDH is generated on the trigger unit and will be described later. Via a low frequency amplifier and a multiplexer the output signal of the T&H gate is applied to the sample and hold gate of an ADC in which the output signal of the T&H gate is taken over and held to the same value for at least the conversion time. The ADC is controlled by the signals TRACK and CLADC which are generated at the Acquisition Control Logic A9 (ACL).

To eliminate faults of the AOC conversion a correction takes place.

In ROLL, DIRECT and SAMPLING (see operating manual and chapter 6.1.1.6.) mode the correction functions as follows:

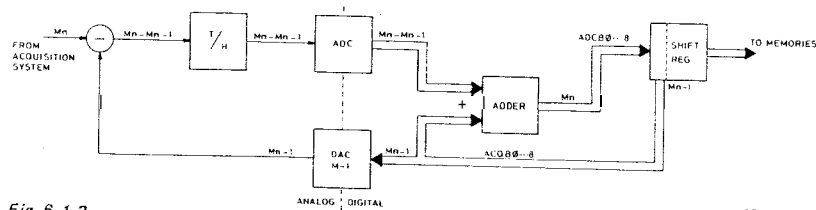

Fig. 6.1.2.

To reduce errors in conversion, analog samples for digitising are compared with preceding samples. these being subtracted so that only small increments are converted to digital values in the ADC. After conversion, the digital equivalent of the original analog signal is produced by adding the differential signal from the ADC to the digital value of the preceding sample.

Referring to the block diagram,  $M_n$  is the new sample of the input signal from the acquisition system;  $M_{n-1}$  is the preceding sample, derived from the shift register and reconverted by DAC M-1 to analog form. At the input to the Track and Hold circuit,  $M_{n-1}$  is subtracted from  $M_n$  to produce a differential analog voltage, which is then converted to digital form in the ADC and added to the preceding digital value  $M_{n-1}$ .

$$\text{i.e. } (M_n - M_{n-1}) + M_{n-1} = M_n$$

After this procedure, the adder output value  $M_n$  will be shifted into a shift register as a new and corrected value. This system of digital adding is also used, in a different way, in the P<sup>2</sup>CCD-mode as described below.

For time base settings of 02 ms/div - 0.5 μs/div the instrument operates in P<sup>2</sup>CCD mode. P<sup>2</sup>CCD means Profiled Peristaltic Charge Coupled Device in which an input signal can be written-in at a high speed and afterwards can be read out at a low speed.

If the instrument operates in P<sup>2</sup>CCD mode, the output of the channel selector is applied to the input amplifier of the P<sup>2</sup>CCD. Because of the principle of the P<sup>2</sup>CCD in dual channel mode the signals - A and B are applied as PAMP OUT 1 and PAMP OUT 2 resp. The P<sup>2</sup>CCD contents is read out by a 78 kHz signal and written in by a Time Base Fast (TBF) pulse via the clock driver input logic. The output of the P<sup>2</sup>CCD is amplified and applied to a multiplexer which switches between the two P<sup>2</sup>CCD outputs. So in the P<sup>2</sup>CCD mode the chopper switch of the channel switch is inoperative.

Output VOUT of the multiplexer is applied to the sample and hold gate of the ADC.

Due to internal P<sup>2</sup>CCD faults and differences between the frequencies  $f_{in}$  and  $f_{out}$ , an incorrect zero level of the P<sup>2</sup>CCD output signal is possible as shown in the following graph.

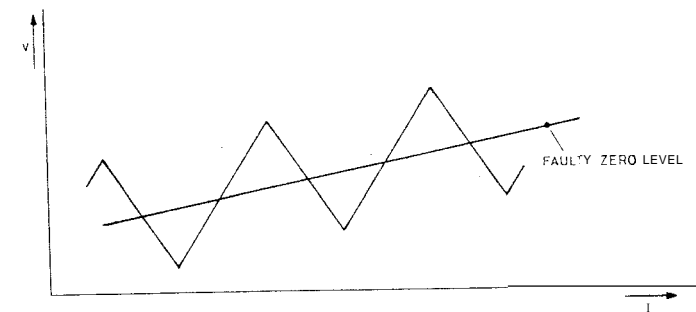
Fig. 6.1.3. P<sup>2</sup>CCD output signal with shifting zero level

MAT 713

Under these conditions, the total faulty contents of the P<sup>2</sup>CCD are converted from analog form to digital in 256 steps and after each conversion the data is put on the ADCB0 ... ADCB8 bus and directly shifted into the 9-bit shift register on buffer unit A7. After 256 steps, the total P<sup>2</sup>CCD contents are stored here, and the register is then blocked.

In order to correct the zero level, the P<sup>2</sup>CCD input is switched to zero by a signal NULIN and 256 samples of this zero signal are shifted into the P<sup>2</sup>CCD at the same frequency  $f_{in}$  as for the normal input signal.

By reading the P<sup>2</sup>CCD contents again, with the same frequency  $f_{out}$  (78 kHz) as for the faulty ADC input signal, an incorrect zero level having the same errors as described above will appear on the P<sup>2</sup>CCD output as shown below.

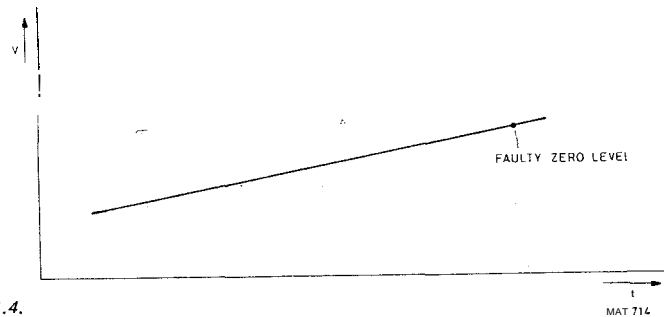

Fig. 6.1.4.

This incorrect zero level is then digitally subtracted (in 256 steps) from the faulty ADC input signal, which was already stored in the shift register. The corrected result is then re-stored in the shift register.

#### 6.1.1.3. Trigger and trigger delay circuits (units A 13 + A22 pages 6-147 + 6-211)

In the trigger channel a signal derived from one of the sources A, B, external or line is applied to the AC/DC switch. The output of this switch is applied to the automatic level circuit which determines the peak-peak value. If automatic triggering is selected the peak-peak value is applied to the level potentiometer to obtain the possibility to level over the complete signal.

In the modes AC or DC a constant voltage is applied to the level potentiometer. In TVF mode the same voltage is applied to both sides of the potentiometer so that leveling is inoperative.

The slope determines which voltage is selected; positive or negative peak voltage.

After amplification the slope is selected and the trigger signal is applied to the pulse stretcher. The TV path in parallel applies its output signal also to the pulse stretcher.

If the TV signal contains equalisation pulses there is a selection to odd or even frame pulses. Otherwise only frame pulses are available at the output.

The pulse stretcher output signal is applied to two circuits: the sampling circuit and the trigger delay circuit.

The trigger delay circuit contains a down counter of which the loading is effected by the microprocessor system via an output port with a value derived from the front panel settings in combination with the TIME/DIV switch setting. Upon the receipt of a trigger pulse from the trigger circuit the down-counter starts counting time base pulses (see also 6.1.1.5.) until its zero state is reached. This effects in a pulse which blocks the reading of new information in the shift register. After this the shift register contents can be copied in the ACCU memory.

#### 6.1.1.4. The sampling system (unit A22 page 6-211)

In sampling mode the output of the pulse stretcher is controlling the fast ramp generator. The ramp is determined by the TIME/DIV switch setting via the microprocessor and the control signals L0 ... L2. The fast ramp output is applied to a comparator. At the other input of the comparator a signal DACSTAIR is applied which is a staircase voltage derived from the ACL counter that increases one step every time that a conversion is completed and a COUNT pulse is counted by the ACL counter. To this staircase voltage a voltage called DACDEL is added which is derived from the trigger delay unit. This is a voltage proportional to the preset trigger delay.

If now the fast ramp voltage reaches the same potential as the sum of DACDEL and DACSTAIR, the system generates a HOCON (Hold and convert) and a TANDH (Track and hold) pulse to start an analog to digital Conversion. If a conversion is completed the output of the pulse stretcher is enabled to generate via the fast ramp generator a new HOCONDERS pulse to start the next conversion. Now the DACSTAIR signal will be increased one stair level so this conversion takes place at the following point of the repetitive input signal.

#### 6.1.1.5. The time base system (unit A12 page 6-135)

With respect to an ordinary oscilloscope this digital storage oscilloscope does not need a sawtooth time base generator because the position on the screen is determined digitally.

Therefore the time-base system consists mainly of frequency dividers.

The base frequency is 2.5 MHz derived from the crystal clock frequency of the microprocessor system. Because the need of higher frequencies than 2.5 MHz a voltage controlled oscillator is introduced with a frequency of 100 MHz. This frequency is kept stable by dividing it by a factor of 80 and to compare it with the microprocessor clockpulse divided by a factor of 2. Now both signals have a frequency of 1.25 MHz and via a feedback loop the VCO is controlled.

For the P<sup>2</sup>CCD mode a TBF signal is generated and in DIRECT and ROLL mode a TBS signal.

The dividing factors, so the frequencies of the TBF and TBS signals, are determined by the setting of the TIME/DIV switch which is decoded by the time base setting decoding.

The frequency of the TBF and TBS signals is such that for one horizontal division on the screen exactly 25 TBF or TBS periods are generated.

#### 6.1.1.6. The acquisition control (unit A9 page 6-92)

The most important part of the acquisition control is a counter which counts the number of conversions by counting COUNT pulses.

Each conversion is initiated by a HOCON (hold and convert pulse) and results after completion into a COUNT pulse.

So it is counting how many input values are written into the shift register.

The acquisition control is operating in a different way for each of the four system modes DIRECT (D) - ROLL (R) - SAMPLING (S) and P<sup>2</sup>CCD (P).

In each of these four modes NDR (New Data Ready) pulses are generated to indicate to the microprocessor that new data is ready and can be copied in the ACCU memory.

The microprocessor in turn answers with SOD pulses telling that the copying of new information into the ACCU memory is completed and that new information can be stored in the shift register.

#### Direct mode

After a hold-off period in which at least 256 new input signal samples are shifted into the shift register, so after a total refreshment of the shift register contents the acquisition system is enabled to react on a new trigger pulse.

Upon the receipt of such a trigger pulse a NDR pulse will be generated just after the completion of the last conversion.

#### ROLL-mode

The ROLL-mode action is started when ROLL-mode is selected and the front panel R/S pushbutton is depressed. This results in the generation of TBS pulses by the time-base unit. These TBS pulses are converted by the trigger unit in HOCONDERS (Hold and convert) pulses which are used in the ACL unit to initiate the conversions of new input signal samples.

After each completed conversion a COUNT pulse is generated and so a NDR pulse.

On each NDR pulse the total shift register contents are copied into the RAM memory and in the same time the shift register output information is shifted again into this shift register by coupling the output of the shift register directly to its input.

Furthermore ROLL-mode functions are under the control of the software.

The software counts the number of NDR pulses and after 256 NDR pulses it saves the ACCU contents into STO3, after again 256 pulses into STO2, then into STO1. After in total 4 x 256 pulses the software stops the ROLL-mode action and indicates this by generating a flashing command for the RUN lamp.

#### Sampling mode

In sampling mode a HOCONDERS pulse is generated on each incoming TRIST pulse except for those coming within the hold-off period. These HOCONDERS pulses initiate conversions of the input signal samples.

After 256 samples are converted and stored in the shift register a NDR pulse is generated and the shift register contents are copied into the ACCU memory.

The microprocessor generates a SOD signal after this copying, the ACL counter is reset to zero and the system reacts again on new incoming triggers.



*P<sup>2</sup>CCD-mode*

After reading in at least 256 samples of new input information into the P<sup>2</sup>CCD circuit, these samples are read out, converted and shifted into the shift register. Then for a period of about 5 ms zero information will be shifted into the P<sup>2</sup>CCD, controlled by the signal NUL HN from the ACL unit which is active in the vertical channels (see also 6.1.1.1.). These zero information is then read out and corrected (see also 6.1.1.2.) with the 256 samples of signal information which was already stored in the shift register and the corrected information is shifted again in the shift register. This total procedure results then in a NDR pulse and copying of shift register contents into the ACCU memory can be started.

6.1.2. Display system

The display part consists of hardware to store and display data on the CRT display. Moreover this part arranges the coding for information to be displayed on pilot and control lamps and on the alphanumeric display. This chapter can be divided in:

- 6.1.2.1. Memories
- 6.1.2.2. Dot join and plot
- 6.1.2.3. Vertical amplifier
- 6.1.2.4. Horizontal amplifier
- 6.1.2.5. CRT section
- 6.1.2.6. Alphanumeric display

6.1.2.1. Memories (unit A6 page 6-61)

The memories are consisting of four separate parts which can be written and read independently. If from the acquisition control logic the signal New Data Ready arrives, new information is written in the ACCU. This means that the contents of the shift register is copied in the ACCU. This information is now read out continuously with a speed, determined so that the display on the CRT seems to be steady. At a "SAVE" command the contents of the ACCU is copied in one or more of the registers STO1 ... STO3. The registers STO1 ... STO3 can only copy information from the ACCU. The only other possibility to write in one of the memories STO1 ... STO3 is with the use of the IEC-bus interface via the databus. The information is stored in the memories as a two-complement notation which means that the data are integers with values from -128 up to and including +127. To convert this in straight binary notation for the YDAC only the most significant bit has to be inverted. After that the complete information can be inverted by operating the push pull knobs "pull to invert". This inversion takes place by an eight-bit-exclusive-or. Via the databus the information can be applied also to the X-DAC. This is necessary in the mode X = A; Y = B.

6.1.2.2. Dot join and plot (unit A20 page 6-178)

If the mode "DOTS" is selected separate dots will appear on the CRT display. The dot join circuit generates straight lines between the consecutively dots. The block diagram of the dot join principle is shown in the figure below.

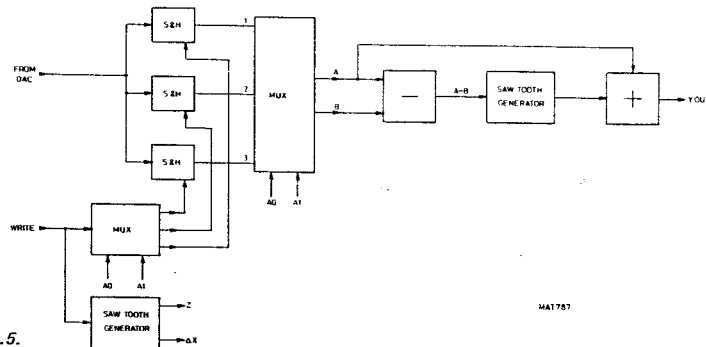

Fig. 6.1.5.

In dual channel operation on points 1 and 3 is always the information of one channel. By the control signals A0 and A1 this information is switched to the output of the multiplexer. Suppose A is the oldest information and B the newest, then, the subtractor output is A-B. This voltage controls the variable sawtooth generator of which the ramp is determined so that the B value is reached before a new write pulse arrives. The output of the sawtooth generator is added to the oldest information A and applied to the final amplifier. If the sawtooth generator is reset the CRT display is blanked. For X-deflection also a sawtooth voltage is generated but now with a fixed ramp and amplitude. The plot action is principally a software matter. The microprocessor system activates the sample and hold gates for the plots so that every 0.25 sec a new sample is taken. This is visible on the CRT display as an intensified point so it is traceable for how far the plot action is got. The speediness is chosen in such a way that a simple chart recorder is able to record the information.

6.1.2.3. Vertical amplifier (unit A20 page 6-178)

After the dot join it is possible to magnify the signal 5x. Now it is possible to obtain the contents of the ACCU or STO1 ... STO3 for full screen deflection. In Y x 1 mode for each memory two divisions are available. Midrange of the position controls effects in displaying the memory base lines on the CRT at resp. 1, 3, 5 and 7 cm with respect to the screen top. This offset is switched to zero if the Y x 5 mode is chosen. Now all base lines of the memories are situated in the centre of the screen. The final amplifier consists of a long tailed pair which drives the CRT directly. This is possible because of the low bandwidth of 1 MHz.

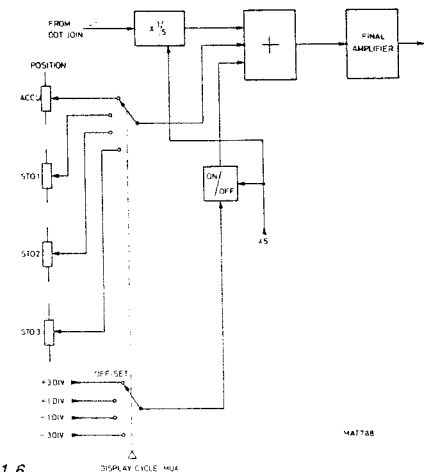

Fig. 6.1.6.

6.1.2.4. Horizontal amplifier (unit A20 page 6-178)

The horizontal amplifier consists of an integrated circuit for the magnifier adjusting and a final amplifier consisting of two shunted feedback pushpull amplifiers. Position control is effected at the input of the integrated circuit.

6.1.2.5. CRT section (unit A15 page 6-157)

Because of the principle of the CRT it is not necessary to correct the barrel and pin cushion distortion. The cathode current of the CRT as used in the concept of this oscilloscope will never yet very high so that a focus voltage dependent to the intensity setting can be arranged automatically. Now there is no need for a front panel focus control. The Z-control is arranged by the microprocessor system. Only if a memory is read the CRT is unblanked. If via the overflow detection a maximum or a minimum value is exceeded this part is displayed with a frequency of approx. 5 Hz so the display blinks.

### 6.1.2.6. Display (unit A2 page 6-25)

There are four front-panel alphanumeric displays:

- channel A V/DIV display
- channel 6 V/DIV display
- s/DIV display
- DIV display.

Each of these alphanumeric displays is an intelligent four-digit unit with a built-in CMOS integrated circuit. The integrated circuit contains a memory, an ASCII-character generator, and a LED multiplexing and drive circuit.

The displays are controlled by the microprocessor, each individual display section being selected by means of addresses fed to the ADDRESS-bus by the microprocessor.

The characters that are required to be displayed are generated by the microprocessor system in Standard ASCII character code and are placed on the databus (signals D0 ... D7).

#### Control and pilot lamps

The NOT TRIG'D. RUN and REMOTE lamps are directly controlled by the signals NOT TRIG'D. RUNL and REM. which are generated on the microprocessor board.

The DISPLAY lamps, the SELECT lamps, the UNCAL A and UNCAL B lamps, the A and B AMPL/DIV control lamps and the TIME/DIV control lamps are controlled by addresses generated by the microprocessor system.

### 6.1.3. Microprocessor (unit A4 page 6-45)

As shown in the simplified block diagram, the micro-processor unit basically consists of the following circuit elements:

- A micro-processor integrated circuit block for controlling and organising data flow.
- Erasable and programmable read-only memories (EPROMs) for system programming.
- Random-access memories (RAMs) for stacking and storing the variable data.
- Address and data selection latches for the multiplexed address bus.
- Decoders for RAM and ROM selection and address decoding.
- Trap and watchdog circuits to guard against loss of data
- Two-way buffer circuit to the system data-bus.
- A blanking circuit for the c.r.t.

The heart of the microprocessor unit is an 8-bit microprocessor type 8085 with 16 address lines. The first eight address lines A0 ... A7 are multiplexed with the eight data lines D0 ... D7 and are defined as AD0 ... AD7. Addressing is selected by the ALE (address latch enable) signal from the microprocessor, which gives an external indication when address information is on the bus-lines.

#### Trap Input Circuit

The TRAP input is effective when the battery back-up facility is used. It prevents the RAM contents being disturbed when the instrument is switched off or in the event of a power failure. The TRAP input forces the microprocessor to continue with the execution of the program at the starting address of the POWER DOWN routine. Failure of the power supply activates the TRAP input of the microprocessor.

A 5 MHz crystal, is connected to the clock inputs of the microprocessor to provide an accurate timing reference source.

A reset signal is generated when the instrument is switched ON. This reset signal forces the microprocessor to start the execution of the main program.

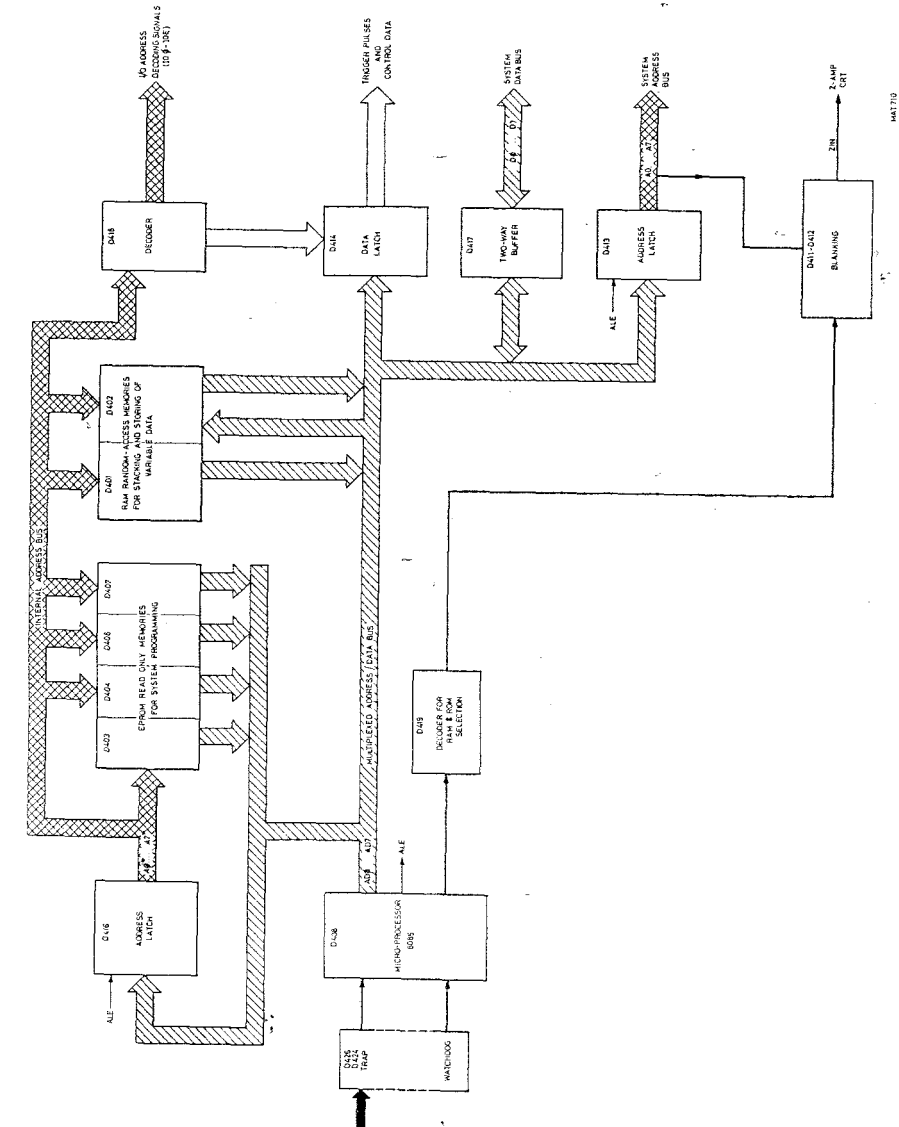

Fig. 6.1.7. Simplified block diagram microprocessor unit.

Connection to the system address bus

The first eight address bits placed by the microprocessor on the multiplexed address-data bus lines AD0 .. A07 have to be separated from the eight data bits.

This separation is achieved by an address latch, which is enabled by signal ALE.

The group of output signals A0 .. A7 constitute the system address bus.

Connection to the system data-bus

The eight data bits placed by the microprocessor on the multiplexed address-data bus lines A00 .. AD7 have to be separated from the first eight address bits.

This separation is done by a bidirectional buffer.

System memory map

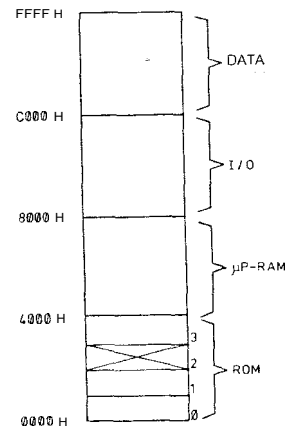

Fig. 6.1.8.

MAT 1249

#### ROM memory

The ROM (read-only memory), which contains the system program, consists of the two EPROM chips of 4K-bytes each (4096x 8 bits).

Because the microprocessor's first eight address lines AD0 .. AD7 are multiplexed in the microprocessor with the data lines, the addresses have to be latched by the address latch 0416 with the aid of the ALE signal.

When a certain ROM address is selected, the contents of the selected location are placed on the multiplexed address-data bus lines A00 .. AD7.

#### RAM memory

The μP-RAM (microprocessor random access memory) is used by the microprocessor for stack purposes and for storage of variable data.

It consists of two RAM chips - of 1/4 K-nibbles each (256x 4 bits), which means that a maximum of 256 bytes of data can be stored.

Each μP-RAM memory address can be selected by the address lines A0\* .. A7\*.

Reading the RAM contents or writing data into a RAM location is controlled by the signals RD\* and WR\*.

The data to be written into, or read from the RAM memory is transported via the multiplexed address-data bus AD0 .. AD7.

#### Blanking circuit

This circuit provides for a blanking signal ZIN (Z-amplifier input) for blanking the trace on the c.r.t. display

#### 6.1.4. Power supply (unit A15 page 6-157 and A16 page 6-1661)

The mains voltage is applied via the mains filter and the mains selector switch on the AC POWER UNIT A16 to a rectifier where it is full-wave rectified and fed to a regulated sine-converter (oscillator and switching circuit).

The output voltage of the sine converter is kept constant by regulating the duty cycle of the applied voltage by a special integrated circuit.

This output voltage is applied to the primary of a transformer, the secondary voltages of this transformer are applied to DC POWER unit A15 where they are full-wave rectified, smoothed and applied to the various circuits.

Also the voltages for the C.R.T. filament and the C.R.T. cathode (-1,5 kV) are generated here. The -1.5 kV is also applied to the EHT unit A23 which gives a high tension for g8 of the C.R.T.

The MAINS triggering is taken direct from the mains and, via an opto-isolator, fed to the trigger circuitry on a safe level.

## 6.2. UNIT DESCRIPTIONS

### 6.2.1. Front side unit A1

The front side unit consists of an aluminium front cast on which the following items are mounted.

- LEO 824 + LEO-holder
- Light reflector assembly inclusive two lampholders and two 28 V - 80 mA lamps E1 and E2.
- CAL output terminals X1 and X2.
- Measuring earth socket X5.
- BNC input socket X6 for external triggering.
- LEVEL/SLOPE control R9/S27.
- INTENS control R15.
- TRACE ROTATION control R16.
- Trigger mode selector switch S29.

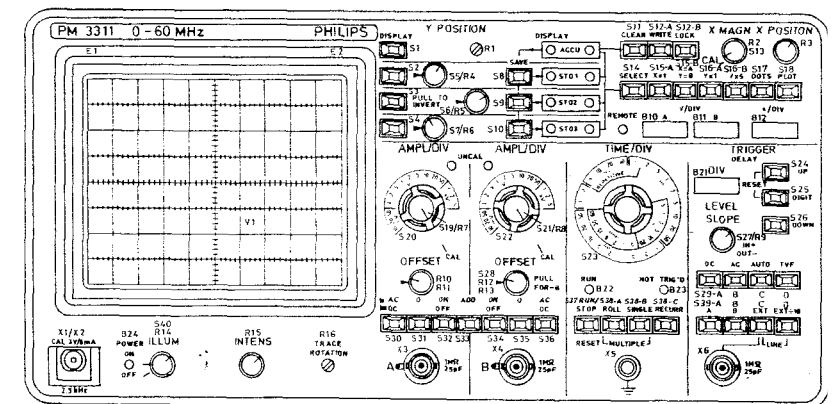

Fig. 6.2.1.

MAT1250

6.2.2. Front unit A2

6.2.2.1. Front board A201

The front board houses all the front-panel control lamps, pilot lamps and alphanumeric displays.

Alphanumeric intelligent displays

There are four front-panel alphanumeric displays:

- channel A V/DIV display
- channel B V/DIV display
- s/DIV display
- DIV display

Each of these alphanumeric displays is an intelligent four-digit unit with a built-in CMOS integrated circuit. The integrated circuit contains a memory, an ASCII-character generator, and a LED multiplexing and drive circuit.

The displays are controlled by the microprocessor, each individual display section being selected by means of addresses fed to the ADDRESS-bus by the microprocessor.

DECADE	A0	A1
0	0	0
1	0	1
2	1	0
3	1	1

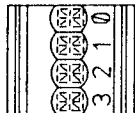

A V/DIV display

DECADE	CONTROL ADDRESS
0	80A0
1	80A1
2	80A2
3	80A3

B V/DIV display

DECADE	CONTROL ADDRESS
0	80A4
1	80A5
2	80A6
3	80A7

s/DIV display

DECADE	CONTROL ADDRESS
0	80A8
1	80A9
2	80AA
3	80AB

DIV display

DECADE	CONTROL ADDRESS
0	80AC
1	80AD
2	80AE
3	80AF

The characters that are required to be displayed are generated by the microprocessor system in Standard ASCII character code and are placed on the data-bus (signals D0 ... D7).

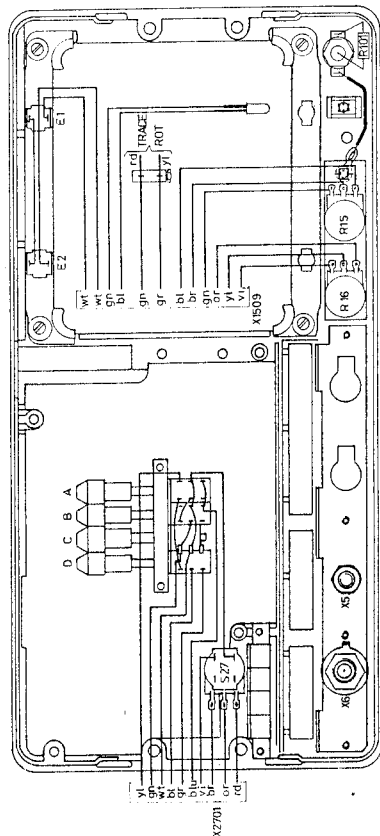
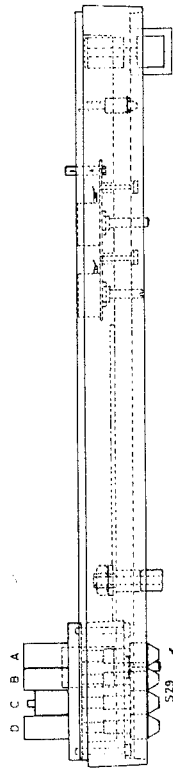
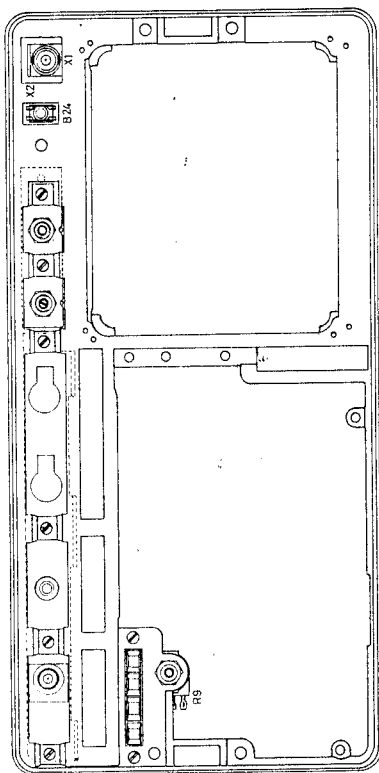

Fig. 6.2.2.

MAT 707A



FRONT BOARD A201

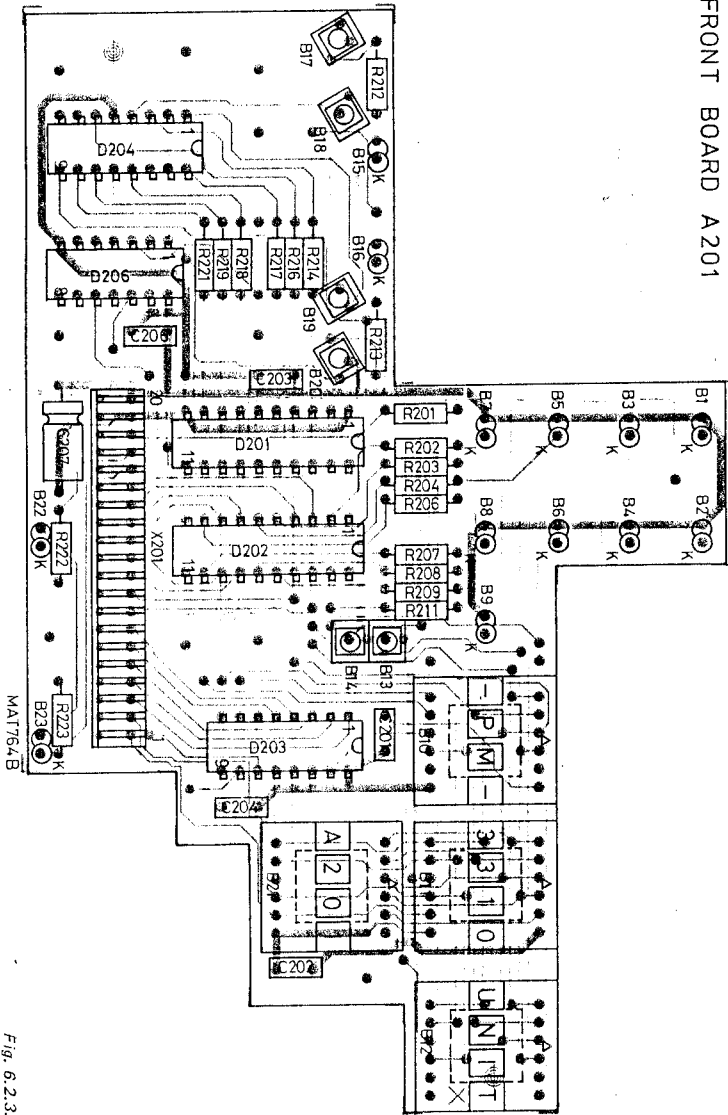
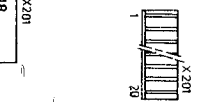
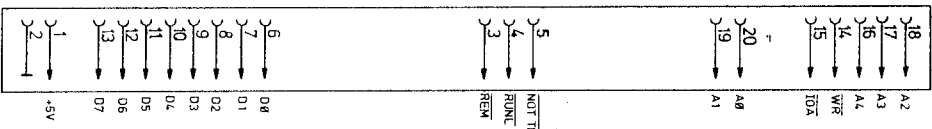
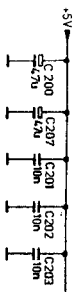
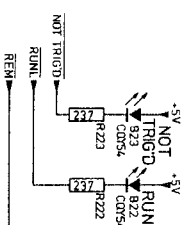
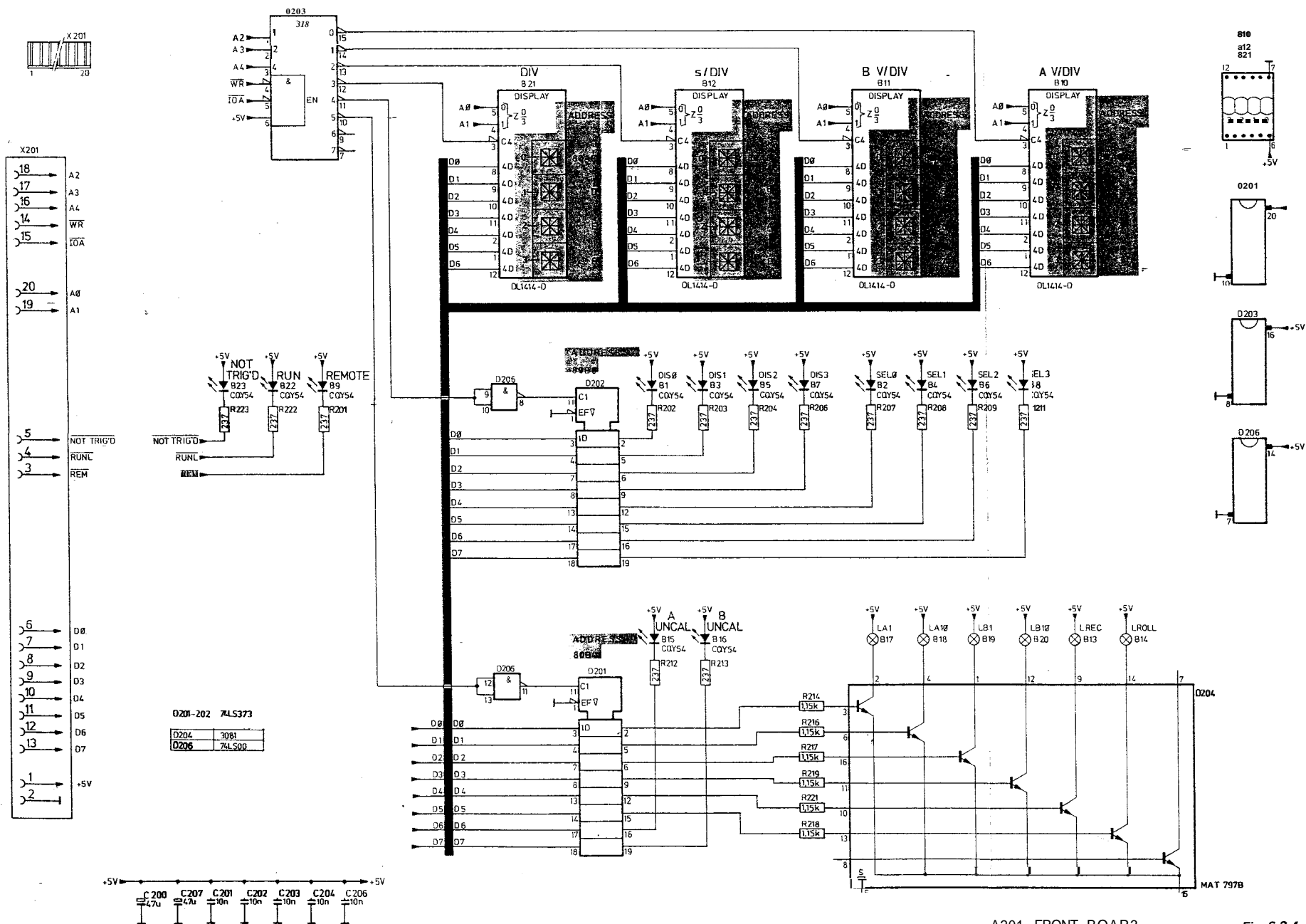

Fig- 6.2.3.



POS	TYPE
D201, D202	74LS373
D203	74LS138
D204	74LS138
D205	74LS138
D206	74LS138





A201 FRONT BOARD3

Fig. 6.2.4.

6.2.2.2. Switchboard A202 and Switch Units A203 ... A207

The front-panel controls listed below are located on these units.

A202 switchboard

SWITCHES	Circuit ref.	Slider signals
YA AMP/L/DIV	S20	Y A1 Y A2 Y A4 Y A5 Y A6 Y A7
YB AMP/L/DIV	S22	Y B1 Y B2 Y B4 Y B5 Y B6 Y B7
TB TIME/DIV	S23	T B1 T B2 T B4 T B5 T B6 T B7
INVEST01	S5	IN V1
INVEST02	S6	IN V2
INVEST03	S7	IN V3
CAL A	S19	CAL A
CAL B	S21	CAL B
IN V B	S28	BIN
SERV 1	XZP1	SERV 1
SERV 2	XZP1	SERV 2
X POSITION	R3	X POS
X MAGN	R2	X MAGN (+12 V in X CAL)
OFFSET A	R10/R11	OFF A
OFFSET B	R12/R13	OFF 8
POS ACCU	R1	POS0
POST01	R4	POS1
POST02	R5	POS2
POST03	R6	POS3
CONTA	i17	ACON
CONTB	i18	BCON

The slider signals of the above-listed potentiometers are applied to various units of the instrument via connector XZ59

Table A

	Y A1	Y A4	Y A5	Y A6	Y A7	Y A2
10 mV/div.	1	1	1	1	1	1
20 mV/div.	1	1	1	1	1	1
50 mV/div.	1	1	1	1	1	1
1 V/div.	1	1	1	1	1	1
.5 V/div.	1	1	1	1	1	1
1 V/div.	1	1	1	1	1	1
2 V/div.	1	1	1	1	1	1
5 V/div.	1	1	1	1	1	1
10 V/div.	1	1	1	1	1	1
20 V/div.	1	1	1	1	1	1
50 V/div.	1	1	1	1	1	1

Table B

	Y B1	Y B4	Y B5	Y B6	Y B7	Y B2
10 mV/div.	1	1	1	1	1	1
20 mV/div.	1	1	1	1	1	1
50 mV/div.	1	1	1	1	1	1
1 V/div.	1	1	1	1	1	1
.5 V/div.	1	1	1	1	1	1
1 V/div.	1	1	1	1	1	1
2 V/div.	1	1	1	1	1	1
5 V/div.	1	1	1	1	1	1
10 V/div.	1	1	1	1	1	1
20 V/div.	1	1	1	1	1	1
50 V/div.	1	1	1	1	1	1

Table C

	T B1	T B2	T B4	T B5	T B6	T B7	T B2
5 mV/div.	1	1	1	1	1	1	1
10 mV/div.	1	1	1	1	1	1	1
20 mV/div.	1	1	1	1	1	1	1
50 mV/div.	1	1	1	1	1	1	1
1 V/div.	1	1	1	1	1	1	1
.5 V/div.	1	1	1	1	1	1	1
1 V/div.	1	1	1	1	1	1	1
2 V/div.	1	1	1	1	1	1	1
5 V/div.	1	1	1	1	1	1	1
10 V/div.	1	1	1	1	1	1	1
20 V/div.	1	1	1	1	1	1	1
50 V/div.	1	1	1	1	1	1	1

RECURR.

HOLL.



6.2.2.2. **Switchboard A202 and Switch Units A203 ... A207**

The front-panel controls listed below are located on these units.

**A202 switchboard**

SWITCHES	Circuit ref.	Switch signals
YA AMPL/DIV	S20	YA1
		YA2
		YA4
		YA5
		YA6
		YA7
		YB AMPL/DIV
YB2		
YB4		
YB5		
YB6		
YB7		
TB TIME/DIV	S23	
		TB2
		TB4
		TB5
		TB6
		TB7
		INV STO1
INV STO2	S6	$\overline{\text{INV2}}$
INV STO3	s7	$\overline{\text{INV3}}$
CAL A	S19	$\overline{\text{CALA}}$
CAL B	S21	$\overline{\text{CALB}}$
INV YB	S28	$\overline{\text{BIN}}$
SERV 1	X241	$\overline{\text{SERV1}}$
SERV 2	X241	$\overline{\text{SERV2}}$

POTENTIOMETERS	Circuit ref.	Slider signals
X POSITION	R3	X POS
X MAGN	R2	X MAGN (+12 V in X CAL)
OFFSET A	R10/R11	OFF A
OFFSET B	R12/R13	OFF B
POS ACCU	R1	POS0
POS STO1	R4	POS1
POSSTO2	R5	POS2
POSSTO3	R6	POS3
CDNT A	R7	ACON
CONT B	R8	BCON

The slider signals of the above-listed potentiometers are applied to various units of the instrument via connector X259

**A203 interconnection board**

Provides the connection between units S201 and A202.

**A204 display switch board**

		Switch signals
DISPLAY ACCU	S1	$\overline{\text{DIS0}}$
DISPLAY STO1	S2	$\overline{\text{DIS1}}$
DISPLAY STO2	S3	$\overline{\text{DIS2}}$
DISPLAY STO3	s4	$\overline{\text{DIS3}}$

**A 205 I delay switch board**

UP	S24	$\overline{\text{UP}}$
DIG	RESET	$\overline{\text{DIG}}$
DOWN	S26	$\overline{\text{DOWN}}$

**A 205 II save switch board**

SAVE STO1	S8	$\overline{\text{SAV1}}$
SAVE STO2	S9	$\overline{\text{SAV2}}$
SAVE STO3	S10	$\overline{\text{SAV3}}$

**A206 clear switch board**

CLEAR	S11	$\overline{\text{CLEAR}}$
WRITE	S12A	-
LOCK	S12B	$\overline{\text{LOCK}}$

**A207 select switch board**

SELECT	S14	$\overline{\text{SEL}}$
X=t	S15A	-
X=A/Y=B	S15B	$\overline{\text{A/B}}$
Yx1	S16A	-
Yx5	S16B	$\overline{\text{Yx5}}$
DOTS	S17	$\overline{\text{DOTS}}$
PLOT	S18	$\overline{\text{PLOT}}$

The settings of all the switches on the above units are read periodically by the microprocessor system via three groups of multiplexers. D241/D247, D242/D248, D243/D249 according to the following table:

ADDRESS	A0F	07	D6	D5	D4	D3	D2	D1	D0
8020	$\overline{\text{RDF0=0}}$	1	YA1	YA4	YA5	YA6	YA7	YA2	$\overline{\text{DIG}}$
8021	$\overline{\text{RDF0=0}}$	0	YB1	YB4	YB5	YE6	YB7	YB2	$\overline{\text{BIN}}$
8022	$\overline{\text{RDE2=0}}$	1	TB1	TB4	TB5	TB6	TB7	TB2	$\overline{\text{UP}}$
8023	$\overline{\text{RDF2=0}}$	0	$\overline{\text{DIS3}}$	$\overline{\text{DIS2}}$	$\overline{\text{DIS1}}$	$\overline{\text{DIS0}}$	$\overline{\text{INV3}}$	$\overline{\text{INV2}}$	$\overline{\text{INV1}}$
8024	$\overline{\text{RDF4=0}}$	1	+5 V	FASA	$\overline{\text{Yx5}}$	$\overline{\text{SEL}}$	$\overline{\text{SAV3}}$	$\overline{\text{SAV2}}$	$\overline{\text{SAV1}}$
8025	$\overline{\text{RDE4=0}}$	0	$\overline{\text{PLOT}}$	0 V	$\overline{\text{DOTS}}$	$\overline{\text{A/B}}$	$\overline{\text{CLEAR}}$	$\overline{\text{LOCK}}$	$\overline{\text{SERV2}}$
									$\overline{\text{SERV1}}$

The selection of one of the multiplexer groups and the internal setting of the selected group is made via the address selector circuit, which consists of NAND-gate D244 (11, 12, 13) and the three-to-eight decoder circuit D246, as shown in the following table:

ADDRESS	$\overline{IO2}$	A3	A2	A1	A0	A0F
8020	0	0	0	0	0	1
8021	0	0	0	0	1	0
8022	0	0	0	1	0	1
8023	0	0	0	1	1	0
8024	0	0	1	0	0	1
8025	0	0	1	0	1	0

INCOMING SIGNAL	OUTGOING SIGNAL	GENERATED ON UNIT	USED ON UNIT	DESCRIPTION
A0 ... A4	ICON 3CON	A4 A202 A202	A21 A21	Address bits from system address-bus Slider of channel A continuous control Slider of channel B continuous control
D0 ... D7	D0 ... D7	A4 A202	A4	Data bits from system data-bus Data bits to system data-bus
DELTRG		A13	A9	Delayed trigger signal
FASA		A9		Output phase flip-flop
FRUN		A13		Freerun signal
$\overline{IO2}$		A4		Input switches select
$\overline{IOA}$		A4		Display select
NOT TRIG'D		A4		I/O address decoding signals
	3FFA	A202	A21	Control for NOT TRIG'D lamp
	OFFB	A202	A21	Slider of channel A OFFSET control
	POS0	A202	A20	Slider of channel B OFFSET control
	POS1	A202	A20	Slider of ACCU position control
	POS2	A202	A20	Slider of STO1 position control
	POS3	A202	A20	Slider of STO3 position control
		A4		Control for REMOTE lamp
		A4		Control for RUN lamp
		A4		Signal READ from microprocessor
		A4		Signal WRITE from microprocessor
	XMAG	A202	A20	Slider of XMAGN control
	XPOS	A202	A20	Slider of X POSITION control
		A15		
		A15		
		A15		
		A15		
		A15		
		A15		
		A15		

REM  
RUNL  
RD  
WR

+5 V  
-12 K  
+12 K  
-12 L  
+12 L

TEST POINTS	
X248	D0
X249	D1
X251	D4
X252	D5

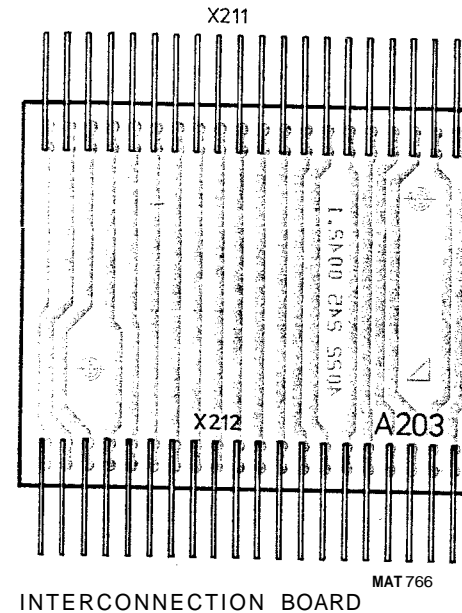

INTERCONNECTION BOARD

Fig. 6.2.5.

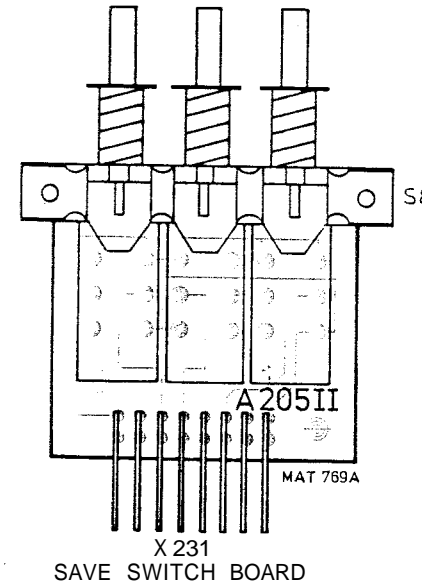

SAVE SWITCH BOARD

Fig. 6.2.8.

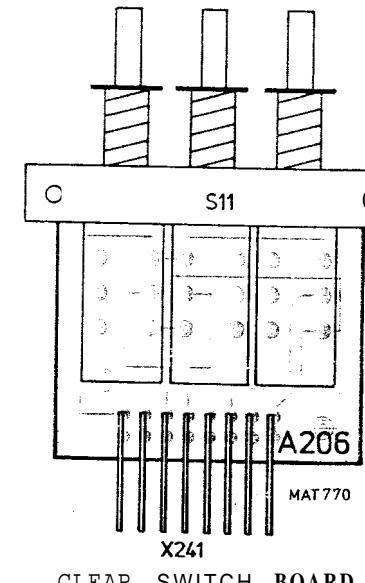

CLEAR SWITCH BOARD

Fig. 6.2.9.

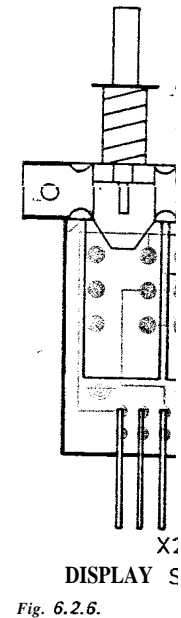

DISPLAY SWITCH BOARD

Fig. 6.2.6.

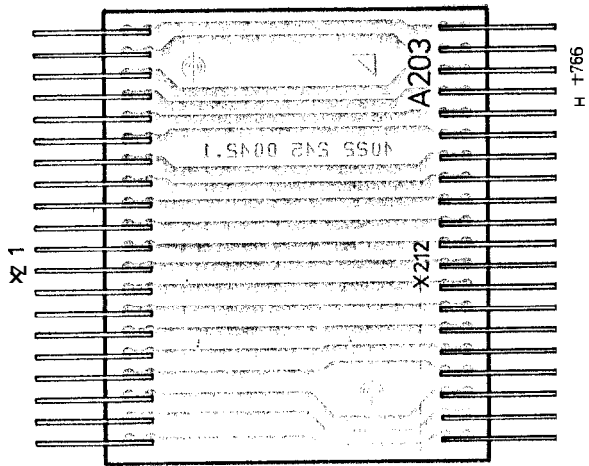

INTERCONNECTION BOARD

Fig. 6.2.5.

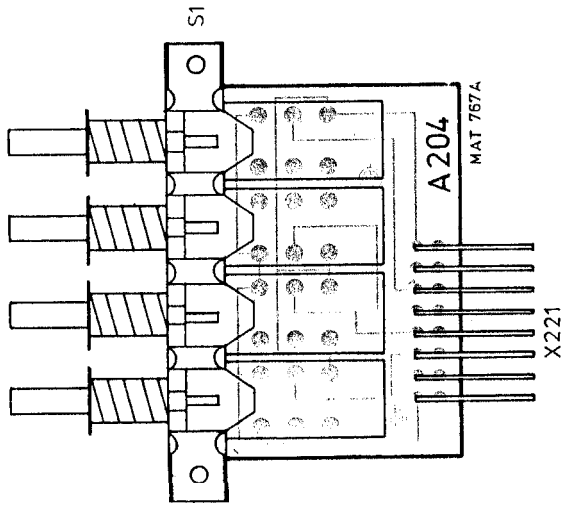

DISPLAY SWITCH BOARD

Fig. 6.2.6.

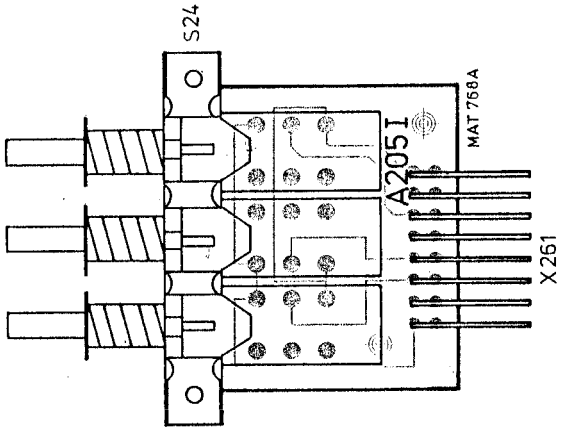

DELAY SWITCH BOARD

Fig. 6.2.7.

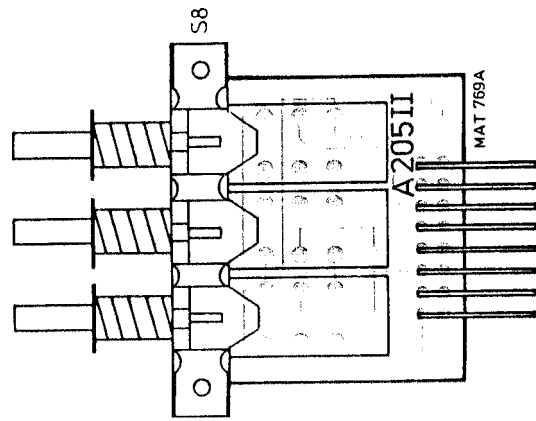

SAVE SWITCH BOARD

Fig. 6.2.8.

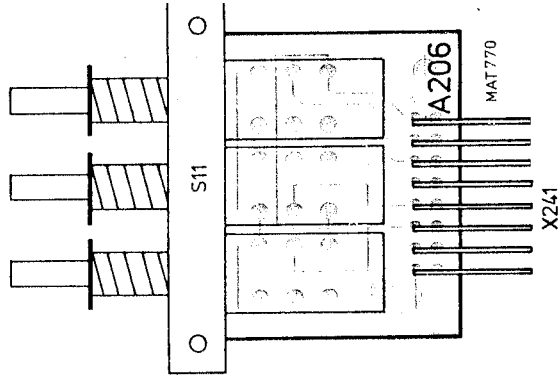

CLEAR SWITCH BOARD

Fig. 6.2.9.

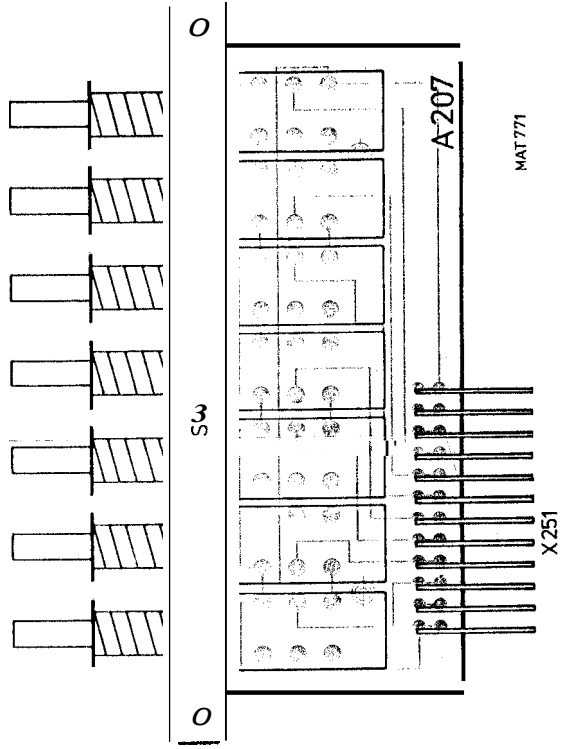

SCALE SWITCH BOARD

Fig. 6.2.10.

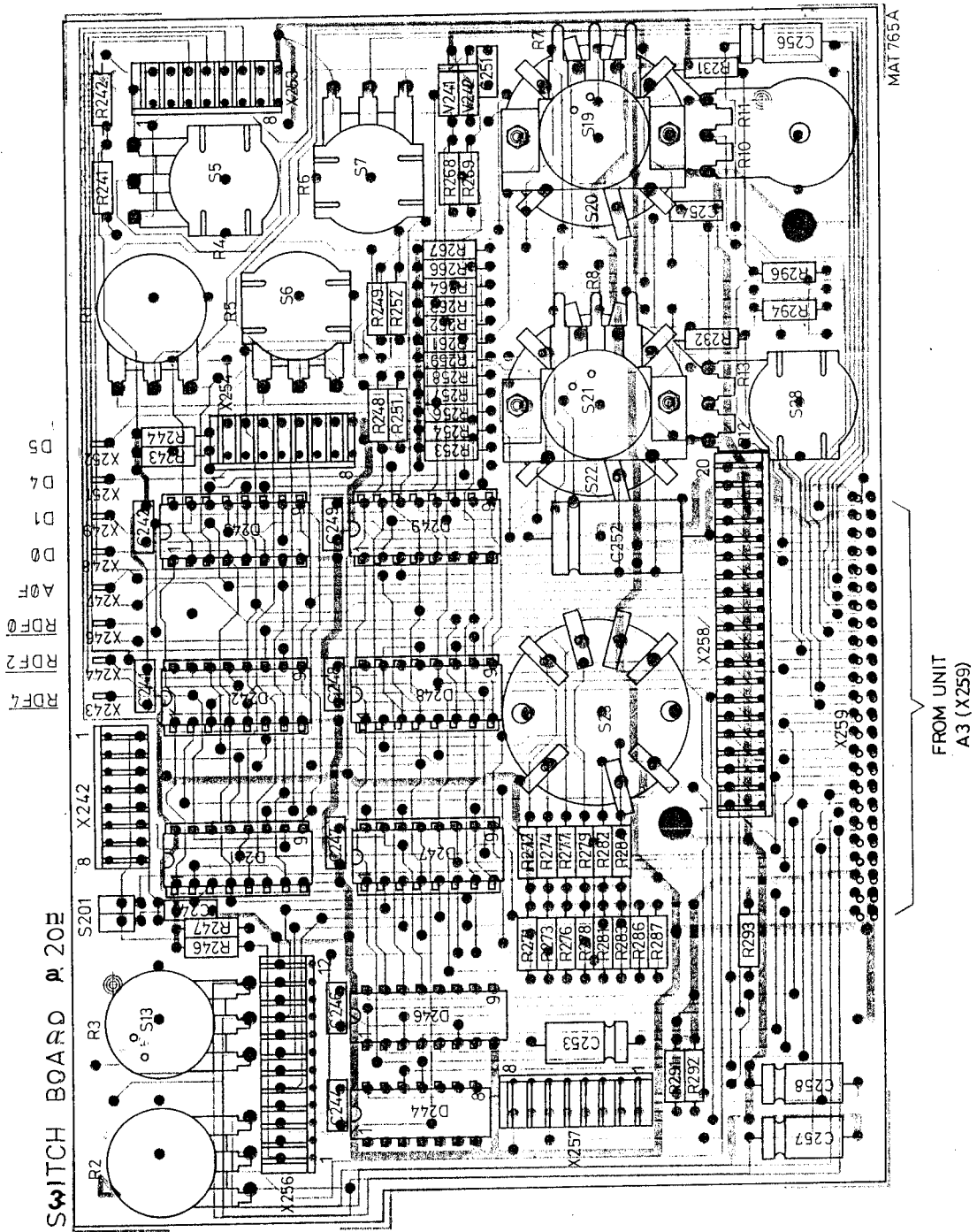

FROM UNIT  
A3 (X259)

Fig. 6.2.11.

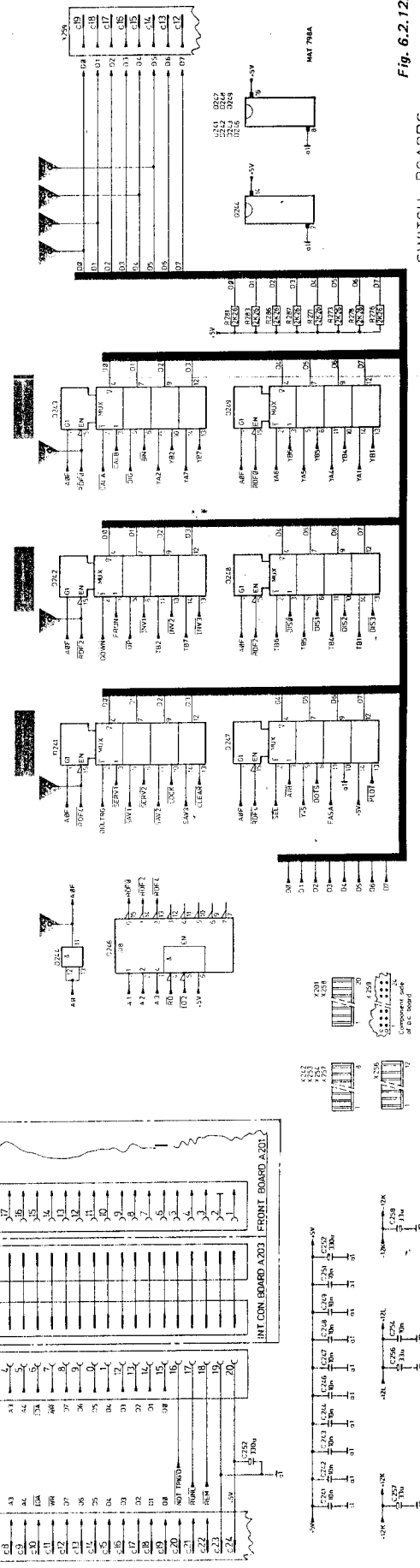
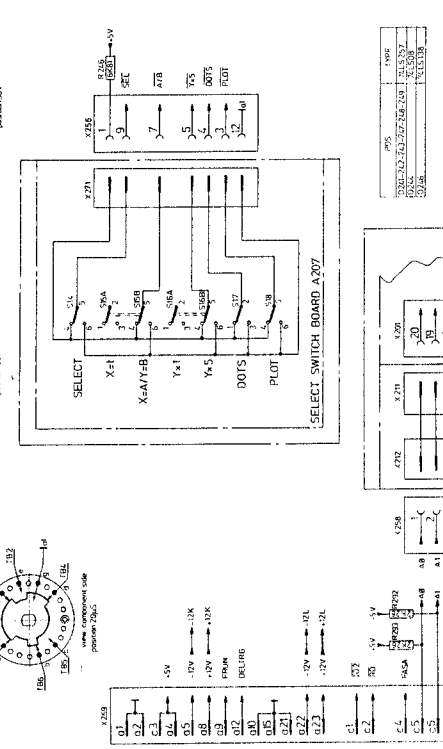
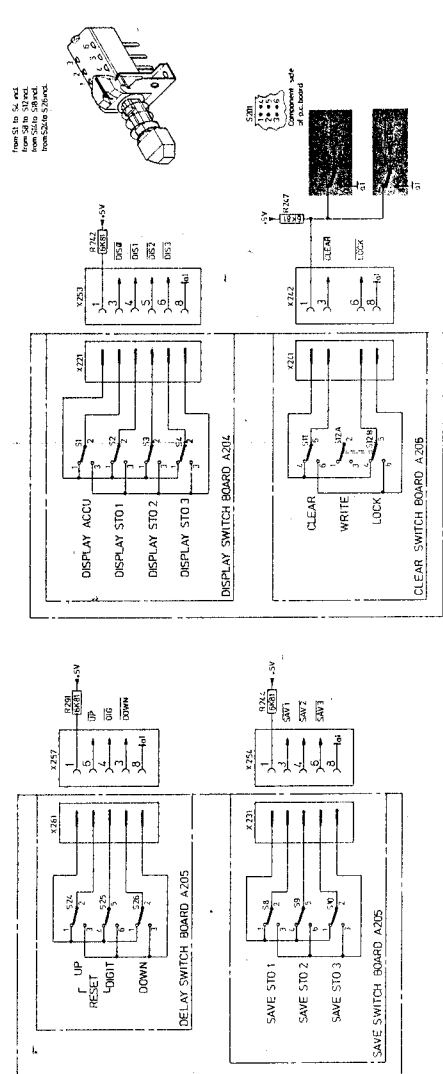
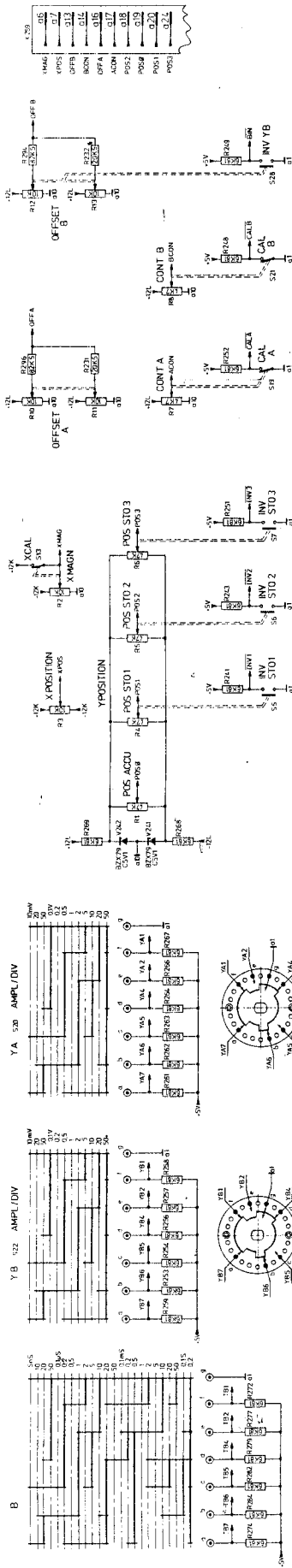

Fig. 6.2.12.

SWITCH BOARDS

6.2.3. Motherboard unit A3

The motherboard unit is installed to interconnect the various plug-in units. No components are mounted on this board.

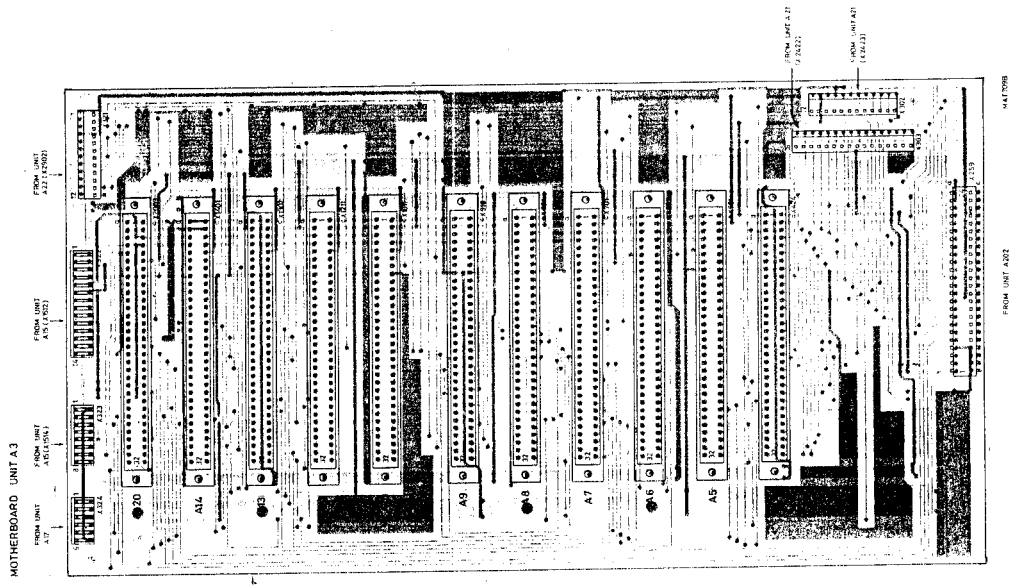
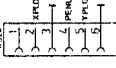
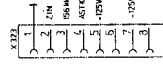
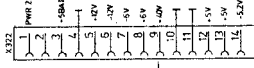
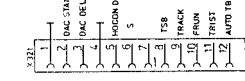
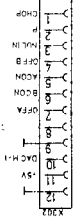

Fig. 6.2.13.



X293	X301	X302	X303	X304	X305	X306	X307	X308	X309	X310	X311	X312	X313	X314	X315	X316	X317	X318	X319	X320	X321	X322	X323	X324	X325	X326	X327	X328	X329	X330	X331	X332	X333	X334	X335	X336	X337	X338	X339	X340	X341	X342	X343	X344	X345	X346	X347	X348	X349	X350	X351	X352	X353	X354	X355	X356	X357	X358	X359	X360	X361	X362	X363	X364	X365	X366	X367	X368	X369	X370	X371	X372	X373	X374	X375	X376	X377	X378	X379	X380	X381	X382	X383	X384	X385	X386	X387	X388	X389	X390	X391	X392	X393	X394	X395	X396	X397	X398	X399	X400	X401	X402	X403	X404	X405	X406	X407	X408	X409	X410	X411	X412	X413	X414	X415	X416	X417	X418	X419	X420	X421	X422	X423	X424	X425	X426	X427	X428	X429	X430	X431	X432	X433	X434	X435	X436	X437	X438	X439	X440	X441	X442	X443	X444	X445	X446	X447	X448	X449	X450	X451	X452	X453	X454	X455	X456	X457	X458	X459	X460	X461	X462	X463	X464	X465	X466	X467	X468	X469	X470	X471	X472	X473	X474	X475	X476	X477	X478	X479	X480	X481	X482	X483	X484	X485	X486	X487	X488	X489	X490	X491	X492	X493	X494	X495	X496	X497	X498	X499	X500
------	------	------	------	------	------	------	------	------	------	------	------	------	------	------	------	------	------	------	------	------	------	------	------	------	------	------	------	------	------	------	------	------	------	------	------	------	------	------	------	------	------	------	------	------	------	------	------	------	------	------	------	------	------	------	------	------	------	------	------	------	------	------	------	------	------	------	------	------	------	------	------	------	------	------	------	------	------	------	------	------	------	------	------	------	------	------	------	------	------	------	------	------	------	------	------	------	------	------	------	------	------	------	------	------	------	------	------	------	------	------	------	------	------	------	------	------	------	------	------	------	------	------	------	------	------	------	------	------	------	------	------	------	------	------	------	------	------	------	------	------	------	------	------	------	------	------	------	------	------	------	------	------	------	------	------	------	------	------	------	------	------	------	------	------	------	------	------	------	------	------	------	------	------	------	------	------	------	------	------	------	------	------	------	------	------	------	------	------	------	------	------	------	------	------	------	------	------	------	------	------

Fig. 6.2.13a.

## 6.2.4. Microprocessor unit A4

### 6.2.4.1. General

As shown in the simplified block diagram, the microprocessor unit basically consists of the following circuit elements:

- A microprocessor integrated circuit block for controlling and organising data flow.
- Erasable and programmable read-only memories (EPROMs) for system programming.
- Random-access memories (RAMs) for stacking and storing the variable data.
- Address and data selection latches for the multiplexed address bus.
- Decoders for RAM and ROM selection and address decoding.
- Trap and watchdog circuits to guard against loss of data.
- Two-way buffer circuit to the system data-bus.
- A blanking circuit for the c.r.t.

The heart of the microprocessor unit is integrated circuit D408, an 8-bit microprocessor type 8085 with 16 address lines.

The first eight address lines A0 .. A7 are multiplexed with the eight data lines D0 .. D7 and are defined as AD0 .. AD7. Addressing is selected by the ALE (address latch enable) signal from the microprocessor, which gives an external indication when address information is on the bus-lines.

### 6.2.4.2. Trap Input Circuit

The TRAP input is effective when the battery back-up facility is used. It prevents the RAM contents being disturbed when the instrument is switched off or in the event of a power failure. The TRAP input can be regarded as a nonmaskable restart input. A logic 1 level on this input forces the microprocessor to continue with the execution of the program starting at address 0024H, the starting address of the POWER DOWN routine.

The signal PWR (power), a 50Hz sine wave signal generated on the power supply unit, is converted to a 50Hz square wave voltage on pin 3 of Schmitt trigger D426 and integrated by C437/R412 to provide pulses on input 11 of the retriggerable oneshot D424.

During the initial switching-on of the power supply, a low voltage on reset input 13 of the one-shot holds the circuit in its reset state. When the power supply is started, however, the retriggerable one-shot switches over and signal PON (power on) goes to logic 1. As long as pulses are generated on input 12, the oneshot will remain in this state.

Failure of the power supply, i.e. no control pulses on input 11, causes the oneshot to be reset and thus activate the TRAP input of the microprocessor. For test procedures, the circuit can be isolated by unsoldering the spot on the printed-circuit track.

### 6.2.4.3. CLOCK inputs X1 and X2

A 5 MHz crystal, 8401, is connected to the clock inputs X1 and X2 of the microprocessor to provide an accurate timing reference source.

### 6.2.4.4. RESIN input and WATCHDOG Circuit

A reset signal is generated when the instrument is switched ON. This reset signal forces the microprocessor to start the execution of the main program beginning at the address 0000H.

The retriggerable one-shot D424 is initially reset by input pin 3 (R) during the switching-on of the instrument. After switching on, the one-shot is set to the logic 1 state by the DT (display timing) pulses from the display timing flip-flop D409, pin 9 on this p.c. board, applied to D424-5.

The oneshot remains in this state as long as the system continues to generate DT pulses.

If these pulses are interrupted, the circuit functions as a watchdog and resets the microprocessor. The oneshot will in fact be reset to logic 0 and a 1 Hz Schmitt oscillator consisting of C432/V402/R421 and D426 will switch the RESIN input of the microprocessor between logic 0 and logic 1.



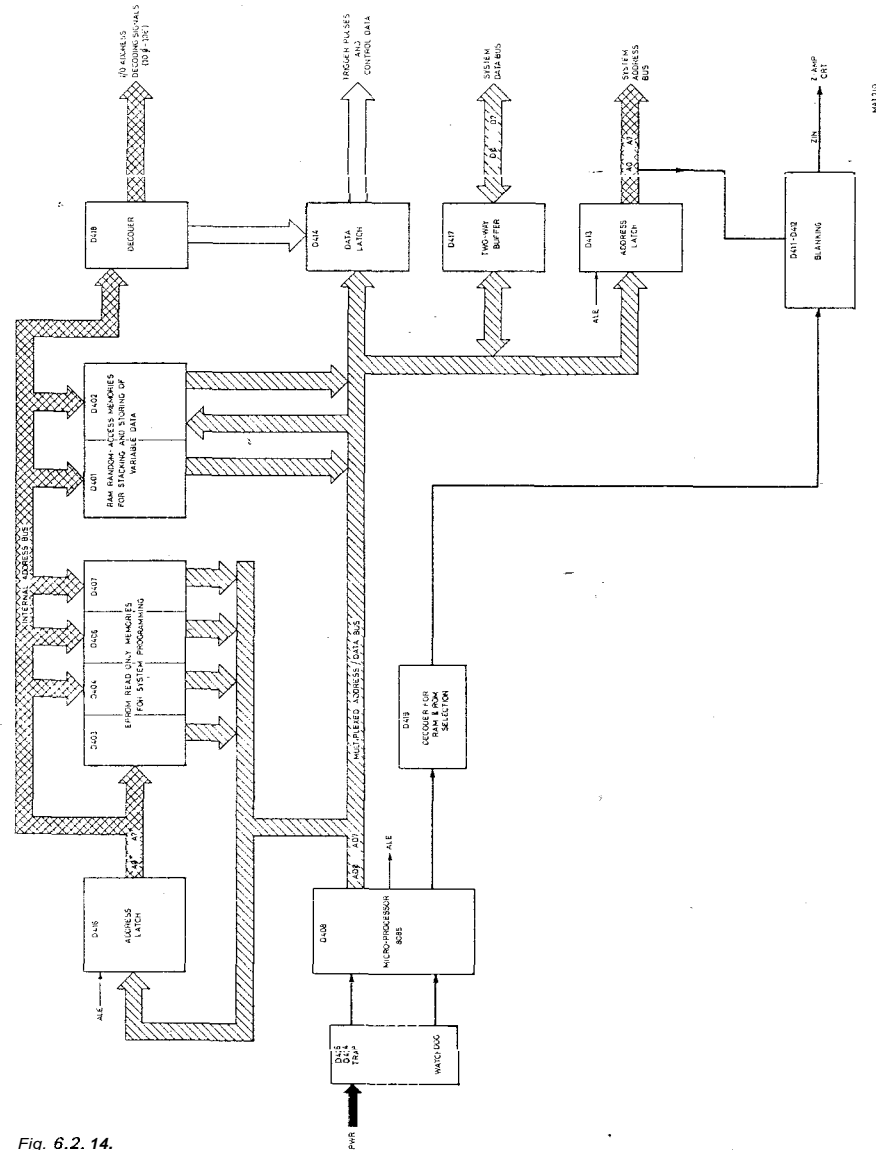

Fig. 6.2. 14.

This reset process continues unless the program resumes correct running.

For test purposes, the watchdog circuit can be replaced by a fixed reset circuit by soldering the spot on the printed-circuit track.

6.2.4.5. RST7.5- RST6.5- RST 5.5 inputs

These restart inputs to the microprocessor force it to continue the program on defined addresses, from where it can jump to different programs.

RESTART INPUTS	PRIORITY	RESTART ADDRESS	REMARKS
RS 7.5	Highest	003CH	Not used in standard instruments (can eventually be used for test purposes)
RS 6.5		0034H	Not used in standard instruments (connected to 'SPARE' connector)
RS 5.5	Lowest	002CH	Used by IEC-bus interface option

6.2.4.6. SID (Serial data input)

The microprocessor will receive the information NDR (new data ready) on the SID input.

6.2.4.7. READY input

Via this input, additional WAIT states are generated to double the RD\* and WR\* pulse duration. This is necessary to provide correct adaption between the microprocessor and the slower acting data RAM circuits. The length of the signals RD\* and WR\* is doubled by flip-flop D423 only when signal DAT is logic 0. The output of this flip-flop D423 is connected to the microprocessor READY input to indicate the end of the wait time.

6.2.4.8. Connection to the system address bus

The first eight address bits placed by the microprocessor on the multiplexed address/data bus lines AD0 ... AD7 have to be separated from the eight data bits. This separation is achieved by address latch 0413, which is enabled by signal ALE.

The group of output signals A0 ... A7 constitute the system address bus.

6.2.4.9. Connection to the system data-bus

The eight data bits placed by the microprocessor on the multiplexed address/data bus lines AD0 ... AD7 have to be separated from the first eight address bits.

This separation is done by the bidirectional buffer D417.

This buffer is selected if address line A15 is logic 1 (as in I/O and DATA part of the memory map). Input or output data depends on the logic level of signal RD\*.

RO' = logic 1 means OUTPUT  
RD' = logic 0 means INPUT

Data is transported between the D417 in- and outputs and the system data-bus over the lines D0 ... D7

SYSTEM MEMORY MAP

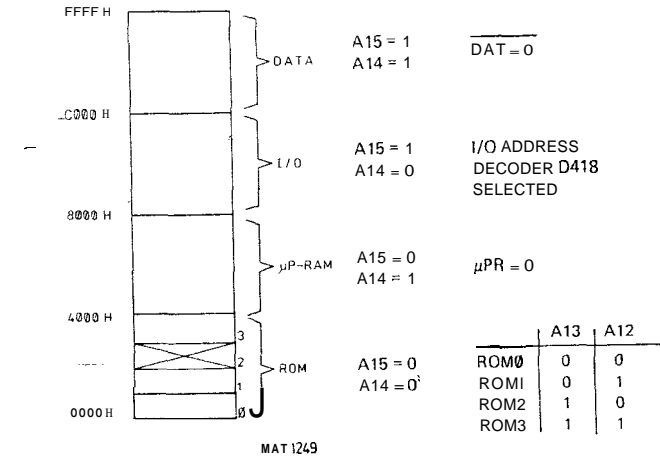
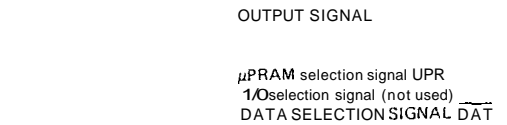

Fig. 6.2.15.

ADDRESS DECODING

6.2.4.10. ROM - μP/RAM - I/O - DATA selection

In decoder D419, four select signals are generated as follows:



ROM chip select signals ROM0 ... ROM3

A15	A14	A13	A12	OUTPUT SIGNAL	ADDRESSES
0	0	0	0	$\overline{\text{ROM0}}$	0000 - 07FF
0	0	0	1	$\overline{\text{ROM1}}$	1000 - 17FF
0	0	1	0	$\overline{\text{ROM2}}$	2000 - 27FF
0	0	1	1	$\overline{\text{ROM3}}$	3000 - 37FF

I/O select signals  $\overline{\text{IO0}}$  ...  $\overline{\text{IOE}}$ .

The three-bit decoder D418 decodes the address bits A15, A14, A7\*, A6\* and A5\* into the eight address decoding signals  $\overline{\text{IO0}}$  ...  $\overline{\text{IOE}}$ . Each of these signals represent a group of addresses as shown in the table. The signals are used in various circuits of the instrument.

A15	A14	A7*	A6*	A5*	OUTPUT SIGNAL	ADDRESSES	TO UNIT
1	0	0	0	0	$\overline{\text{IO0}}$	8000 - 801F	A21 AMPLIFIER
1	0	0	0	1	$\overline{\text{IO2}}$	8020 - 803F	A2-A4 SWITCHES + μP
1	0	0	1	0	$\overline{\text{IO4}}$	8040 - 805F	A6 RAM
1	0	0	1	1	$\overline{\text{IO6}}$	8060 - 807F	A12 TIME-BASE
1	0	1	0	0	$\overline{\text{IO8}}$	8080 - 809F	A13 TRIGGER DELAY
1	0	1	0	1	$\overline{\text{IOA}}$	80A0 - 80BF	A2 DISPLAY
1	0	1	1	0	$\overline{\text{IOC}}$	80C0 - 80DF	NOT USED
1	0	1	1	1	$\overline{\text{IOE}}$	80E0 - 80FF	A14 IEC OPTION

ROM MEMORY

The ROM (read-only memory), which contains the system program, consists of the two EPROM chips 0403- D404 and 4K-bytes each (4096X 8 bits).

Because the microprocessor's first eight address lines AD0 ... AD7 are multiplexed in the microprocessor with the data lines, the addresses have to be latched by the address latch 0416 with the aid of the ALE signal. The ALE signal enables the latching of the AO' ... A7' signals. These AO' ... A7' signals are placed on the microprocessor board internal address bus.

Each ROM memory address can be selected by the address lines A0\* ... A7' together with address lines AS- A9 - A10 and A11.

Each ROM memory chip is selected by the read signal  $\overline{\text{RD}}^+$  and the relevant ROM selection signal  $\overline{\text{ROM0}}$ ,  $\overline{\text{ROM1}}$ ,  $\overline{\text{ROM2}}$  or  $\overline{\text{ROM3}}$ .

When a certain ROM address is selected in this way the contents of the selected location are placed on the multiplexed address/data bus lines AD0 ... AD7.

μP RAM MEMORY

The μP RAM (microprocessor random access memory) is used by the microprocessor for stack purposes and for storage of variable data.

It consists of two RAM chips D401 - D402 of 1/4K nibbles each (256 x 4 bits) which means that a maximum of 256 bytes of data can be stored.

Each μP RAM memory address can be selected by the address lines A0\* ... A7'. The two chips are selected by the signal combination  $\overline{\text{PON}}$  UPR.

Reading the RAM contents or writing data into a RAM location is controlled by the signals  $\overline{\text{RD}}^+$  and  $\overline{\text{WR}}^+$ .

The data to be written into or read from the RAM memory is transported via the multiplexed address/data bus AD0 ... AD7.

DATA LATCH D414

When the microprocessor places the address 8020 on the multiplexed address/data bus, this results in signal  $\overline{\text{IO2}}$  going to logic 0. This  $\overline{\text{IO2}}$  combined with the  $\overline{\text{WR}}$  signal on gate D421 enables data latch D414 to latch the byte of data present on the multiplexed address/data bus.

The byte of data consists of the following signals

BIT 0	$\overline{\text{CLR}}$	Clear signal for clearing the shift register
BIT 1	REM	Control signal for REMOTE lamp
BIT 2	$\overline{\text{NOTTRIG'D}}$	Control signal for NOT TRIG'D lamp
BIT 3	ZEN	Z enable signal
BIT 4	RUNL	Control signal for RUN lamp
BIT 5	BL0L	Blinking overload signal
BIT 6	INV	Invert signal for RAM output data
BIT 7	CLDT	Clear display timing flip flop

## BLANKING CIRCUIT

This circuit provides for a blanking signal ZIN (Z-amplifier input) for blanking the trace on the c.r.t. display.

ZIN = logic 1 means blanking

The trace on the c.r.t. display is only present if all the input signals of NAND circuit D411 are logic 1 at the same time.

- pin 4 The signal ZEN is only present during the time that a selected memory [ACCU, STO1, STO 2 or STO3] is displayed-
- pin 11 If an overflow is detected on the RAM unit the short signal ZDVL (Z-overflow), will be latched in a D-type flip-flop D423 with the dock signal DAT.WR. As the output signal of the flip-flop is connected to OR circuit D421, the blinking overload signal is passed to pin 11 of the NAND D411, resulting in blinking of the trace at a low frequency.
- pin 3 In mode DOTS, the ZDJ (Z dot join) blinking signal will be active
- pin 5 Signal DT [display timing] blanks the trace when no memory contents (ACCU, STO1, STO2 or STO3) are displayed. Signal DT is derived from the addresses, which are also applied to the XDAC for horizontal deflection.

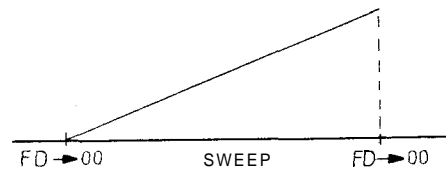

NAND circuit D412 detects the address FDH on the first eight address lines. The output signal indicates the beginning and the end of a sweep by going to logic 1 level. This signal is latched in D-type flip-flop D409 with the clock signal DAT.WR, resulting in a signal DT. The trace is blanked if DT = logic 0. Flip-flop D409 can be reset by signal CLDT (clear display timing flip-flop) resulting in a blanked trace.

- pin 1 In mode X = A/Y = B [A versus B - AVSB) a signal ZAB is generated on output pin 5 of flip-flop D409. Data can only be latched in this flip-flop on clock signal DAT.WR. This data is derived from signal A0AB. (A0AB is address A0 in mode X = A/Y = B)

## TRIGGER PULSES FOR TEST PURPOSES

Trigger pulse 'START MAINLOOP' is available at X407  
 Trigger pulse "START DISPLAY LOOP" is available at X409  
 Trigger pulse 'START DELAY LOOP' is available at X412

INCOMING SIGNAL	OUTGOING SIGNAL	GENERATED ON UNIT	USED ON UNIT	DESCRIPTION
A0AB AVSB	A0 ... A7	A4 A6 A13	.46	Address bits from system address bits Address bit A0 in X = A/Y = B mode Logic 0 in X' = A/Y = B mode
	3LOL CLK CLR	A4 A4 A4		Blinking overload Microprocessor clock pulse output signal (2.5 MHz) Clear signal for shift register
D0 ... D7	D0 ... D7	A4-A6	A8-A9	Data bits from system data-bus
	DAT	A4	A6	Data selection
	DT	A4	A13	Display timing
	INV	A4	A6	Signal invert-
	100	A4	A421	Input switches select
	102	A4	A4202	Input switches select (A2)
	104	A4	A6	Output port select (A4)
	106	A4	A12	Data RAM select (A6)
	108	A4	A13	Time-base select (A12)
	10A 10C 10E	A4 A4 A4	A201/A202 NOT USED 414	Delay trigger unit settings (A13) Display select (A2)
NDR	NOT TRIG'D	A4	A201/A202	New data ready Control for NOTTRIG'D lamp
	PON	A4	A6	Power on
PWR	RD	A15 A4		Power signal (20 kHz) Signal READ from microprocessor
	REM RESOUT	A4 A4	A201/A202 A14	Control for REMOTE lamp Microprocessor RESET OUTPUT signal
RST5,5 RST6,5		A14 A5 A4		Restart 5,5 input from IEC-bus interface Restart 6.5 input (not used)
ZDJ	RUNL SOD WR	A4 A4 A4	A201/A202 A6-7-9	Control for RUN lamp Microprocessor serial output data Signal WRITE from microprocessor
	ZEN	A13 A4		Z dot join Z enable
	ZIN	A4	A15	Z input
ZOVL		A6		Z overflow signal
+5 V		A15		
+5 BATT		A15		

I/O address decoding signals.

TEST POINTS	
X401	D421-pin 6 (WR.DAT)
X402	PON
X403	UPR
X404	DT
X406	ROM0
X407	ROM
X408	ROM1
X409	ROML
X411	ROM2
X412	NOT TRIG'D
X413	ROM3
X414	ALE
X416	A15
X417	NDR
X418	SOD
X419	RD*
X421	CLK (OUT)
X422 -	WR*
X423	■

### MICROPROCESSOR UNIT A4

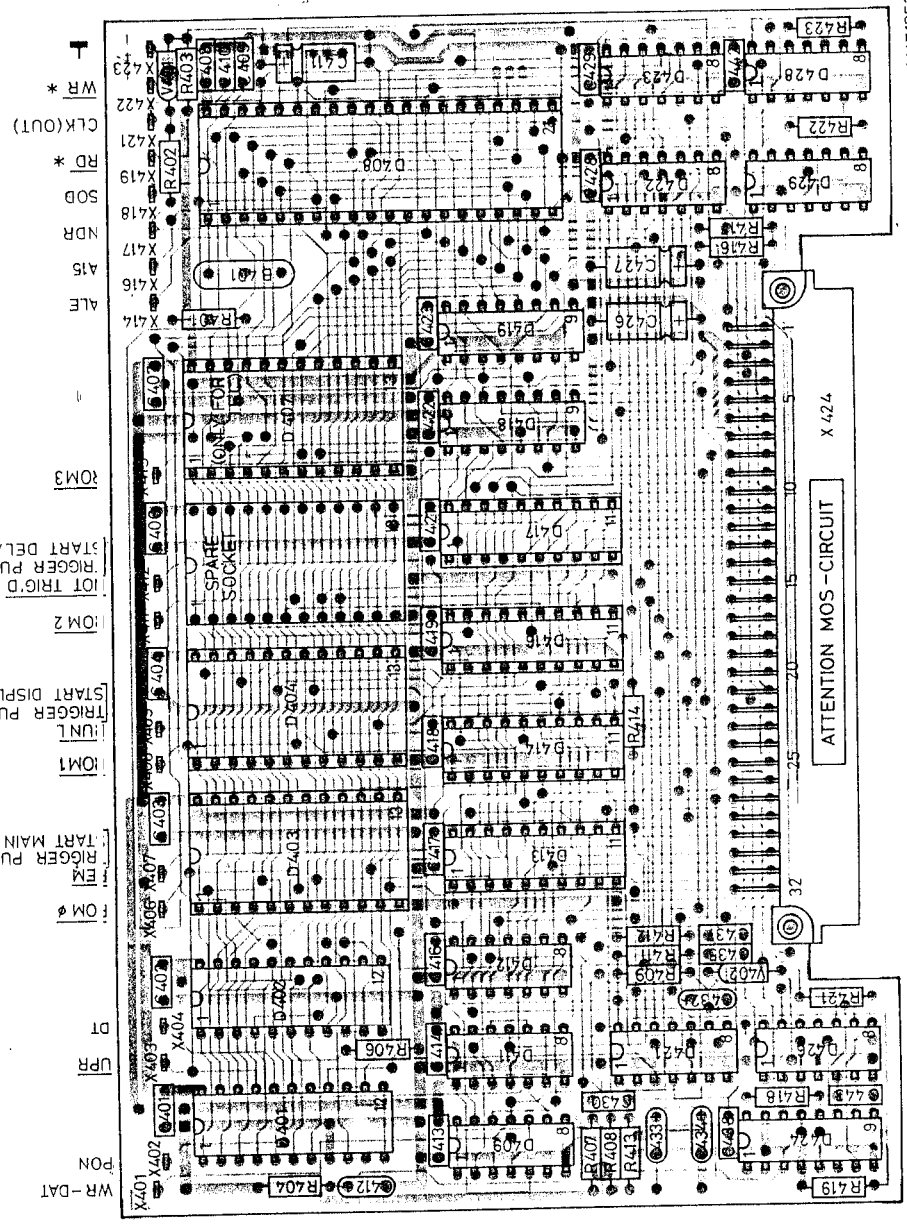
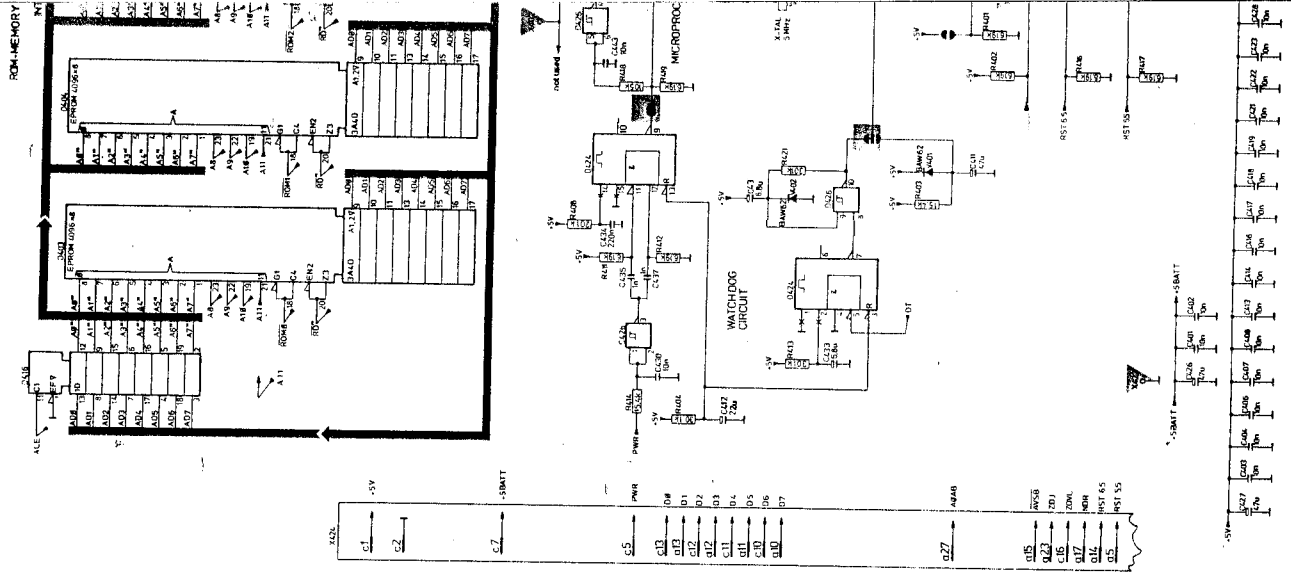

Fig. 6.2.16.



MAT1252

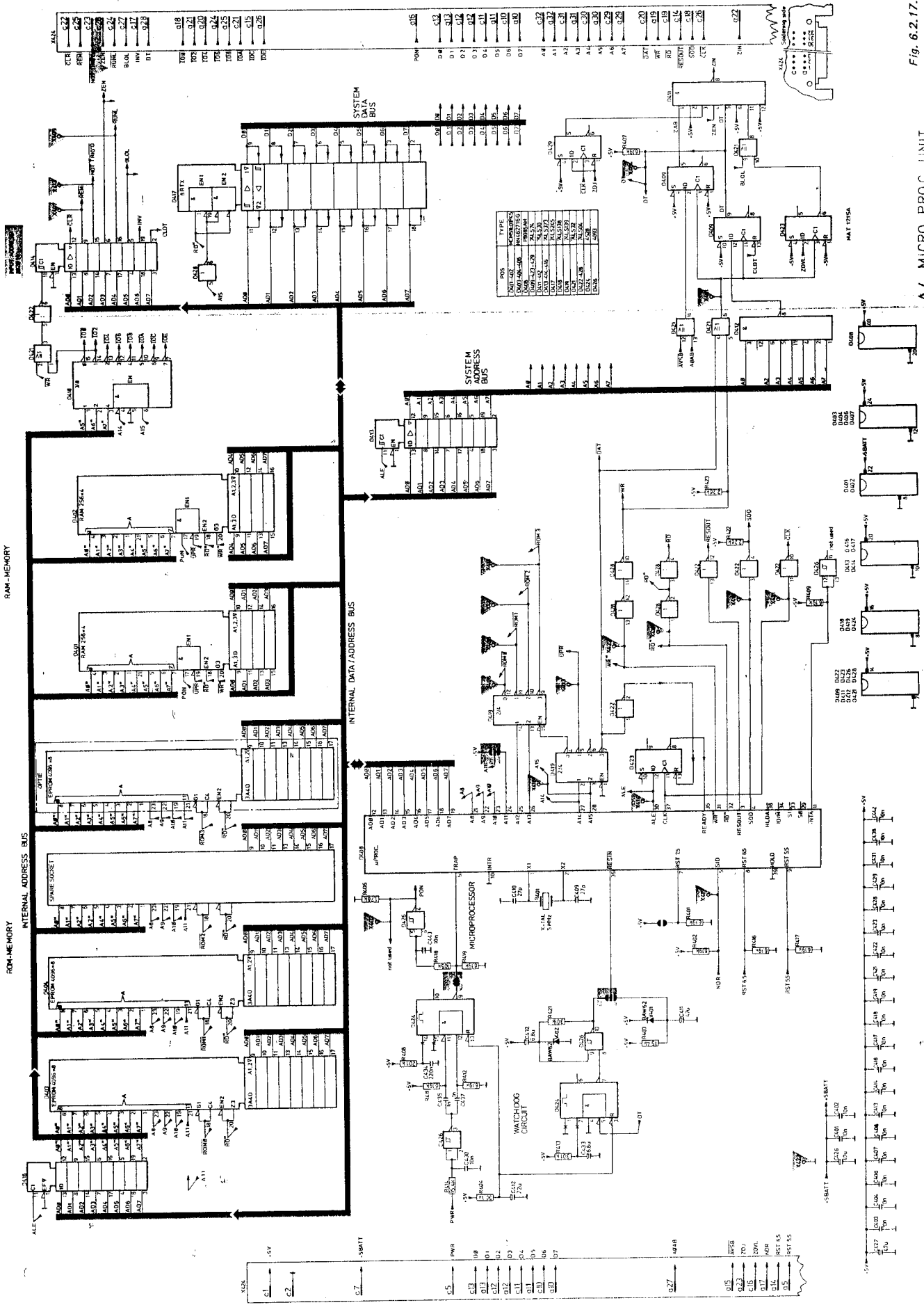

Fig. 6.2.17.

A4 MICRO PROC. UNIT

## 6.2.5. Spare unit A5

There is a connector X501 available on the motherboard unit A3 in which no plug-in unit is placed.

On this connector X501 a number of signals are available for measuring purposes.

A1	+5 V	C1	+5 V
A2	0 V	C2	0 V
A3	1-12 V	C3	+12 V
A4	-12 V	C4	-12 V
A5	ZIN	C5	PWR2
A6	XDAC	C6	YDAC
A7	+5 BATT	C7	+5 BATT
A8	0 V	C8	0 V
A9	+6 V	C9	-6 V
A10	D7	C10	D6
A11	D5	C11	D4
A12	D3	C12	D2
A13	D1	C13	D0
A14	RST 6.5	C14	RES OUT
A15	AVSB	C15	IOC
A16	PON	C16	ZOVL
A17	NDR	C17	INV
A18	IO0	C18	SOD
A19	WR	C19	RD
A20	IO4	C20	DAT
A21	IO2	C21	IOA
A22	ACQB3	C22	ACQB7
A23	ACQB2	C23	ACQB6
A24	ACQB1	C24	ACQB5
A25	ACQB0	C25	ACQB4
A26	—	C26	2.5 MHz
A21	OER3	C27	OER2
A28	OER1	C28	OER0
A29	A7	C29	A6
A30	A5	C30	A4
A31	A3	C31	A2
A32	A1	C32	A0

## 6.2.6. RAM unit A6

The RAM unit basically comprises the four random-access memories. ACCU, STO1, STO2, STO3 used for signal storage, the two digital-to-analog converters X DAC and Y DAC and their associated control circuits

## 6.2.6.1. RAM memories ACCU, STO1, STO2, STO3

Each of the RAM memories consists of two RAM IC-chips of 1/2K-nibbles each (256x4 bits) enabling a maximum of 256 bytes to be stored.

The overall memory is selected by PON.DAT = 1, i.e. with the power on and the data field addressed. Memory allocation is as follows:

MEMORY	IC ELEMENTS
ACCU	D601, D602
STO1	D603, D604
STO2	D606, D607
STO3	D608, D609

Selection of one or more of the memories is made under microprocessor control.

A byte of data representing the information for reading or writing one or more of the memories is sent by the microprocessor on data-lines D0 ... D7 to the latch D613. If the signal combination WR.104 is logic 1, the data byte will be latched by D613.

Two groups of output signals are produced by latch D613:

- Output Enable RAM signals (OER) — signals  $\overline{OER0}$  ...  $\overline{OER3}$  select the memory of which the contents are required to be read.
- Write Enable RAM signals (WRER) — signals  $\overline{WRER0}$  ...  $\overline{WRER3}$  select the memory in which data is required to be written. With no WR signal available these signals are blocked.

Individual RAM locations are selected by address lines A0 ... A7

*Data inputs for the memories*

Data received from other units can only be stored in the ACCU RAM.

Data stored in any of the other three memories STO1, STO2, STO3, is always derived from the ACCU memory.

Data for storage in the ACCU memory (D601, D602) can be:

- output data ACQB0 ... ACQB7 from the acquisition circuit,
- data from the microprocessor,
- data from the IEC-bus Interface board via the system data-bus lines D0 ... D7.

The signals ACQB0 ... ACQB7 are applied to the latch D614 and the signals D0 ... D7 are applied to the latch D616.

Selection of either one of these latches is made under microprocessor control via the logic level of signal SOD (serial output data).

$\overline{SOD} = 1$  selects D614  
 $\overline{SOD} = 0$  selects D616 via inverter D626

Inverter D626 prohibits the output of data from both latches to the ACCU bit lines at the same time

### Overflow detection

The information in the RAMs is stored in 2's complement notation, which means that signal amplitudes are stored in positive as well as negative binary numbers.

maximum positive	+127	0111 1111
	+1	00000001
	+0	00000000
	-1	1111 1111
maximum negative	-128	1000 0000

From the above, we can see that if the most-significant bit of a binary number is at logic 0, we have a positive number, otherwise it represents a negative number.

An incorrect setting of the AMPL/DIV switch or the OFFSET control causes an overflow, which means that the result after digitising is greater than can be stored. Therefore, if the maximum number 0111 1111 or the minimum number 1000 0000 is reached, an overflow situation is recognised. This is signalled by a flashing trace on the c.r.t. display.

These two extreme overflow situations can be decoded as follows:

The most-significant bit D7 is inverted by 0626 (1,2) resulting in the overflow codes 0000 0000 or 1111 1111. By comparing the inverted most-significant bit with the other seven bits in exclusive OR circuits D618 and D619, an output signal ZOVL (Z Overload) is indicated when one of these two overflow situations occurs. The overflow signal ZOVL is applied to the Z-pulse (ZIN) circuit on Unit 4 to produce the flashing of the display when overload is reached.

### 6.2.6.2. Digital-to-analog converters X DAC, Y DAC

DAC output signals in X = t mode

Horizontal deflection on the c.r.t. display in the X = t mode is controlled by the addresses needed for reading the contents of the memories. Therefore, the address bits A0 ... A7 are applied to the X DAC (horizontal digital-to-analog converter) D622 to generate an analog deflection signal XDAC that varies between +5 V and -5 V.

The address bits are applied to the X DAC (D622) via two multiplexers D611 and D612, which are controlled by the signal AVSB.

$\overline{AVSB} \approx 1$  selects X = t mode  
 $AVSB \approx 0$  selects X = A / Y = B mode

Vertical deflection on the c.r.t. display is controlled by the eight data bits D0' .. D7', which are applied to the Y DAC (D621) to generate an analog deflection signal Y DAC.

These data bits are routed to the Y DAC via eight exclusive OR gates D623, D624, which are controlled by the INV signal to invert the data when the front-panel INV switches are operated.

The X DAC and Y DAC latches can be enabled by the enable signals X DACE and Y DACE respectively. These are the output signals from the multiplexer D628, which is enabled by the DAT signal. Selection of input signals to the multiplexer is made by the signals A0AB and AVSB according to the following table:

$\overline{AVSB}$	A0AB	$\overline{XDACE}$	$\overline{YDACE}$
0	0	WR	WR
0	1	WR	WR
1	0	WR	WR
1	1	WR	WR

X=A/Y=B mode

X=t mode

DAC output signals in X = A/Y = B mode

If channel A as well as channel B information is stored in the RAMs, XY deflection can be obtained by selecting the X = A/Y = B mode by depressing the relevant front-panel switch.

To give XY deflection, the channel information on A and B has to be applied to the X DAC and the Y DAC respectively.

There are two different methods of storing the channel A and channel B information in the RAMs.

**Channel A ODD:** Channel A information is stored in locations with ODD addresses and channel B in locations with EVEN addresses.

**Channel A EVEN:** Channel A information is stored in locations with EVEN addresses and channel B in locations with ODD addresses.

To obtain XY deflection, it is necessary to apply data from the ODD addresses to the X DAC and data from the EVEN addresses to the Y DAC or vice versa depending on the logic level of the FASDI signal.

For correct functioning, only one DAC latch may be enabled at a time, this being controlled by the enable signals  $\overline{XDACE}$  and  $\overline{YDACE}$  on the output of multiplexer D628.

The logic level of signal FASDI (phase of display) controls which channel is stored in odd or even addresses by determining which DAC is loaded first. If FASDI is at logic 0, we have the situation where X DAC (latch D622) is loaded first: i.e. channel A will be stored in the odd addresses.

Alternatively, if FASDI is at logic 1, then Y DAC (latch D621) will be loaded first and channel B will be stored in the odd addresses.

FASDI	A0	A0AB
0	0	1
0	1	0
1	0	0
1	1	1

FASDI = 0 results in A0 being inverted

FASDI = 1 results in A0 not inverted



INCOMING SIGNAL	OUTGOING SIGNAL	GENERATED ON UNIT	USED ON UNIT	DESCRIPTION
A0 ... A7		A4		Address bits from system address bus
	A0AB	A6	A4	Address bit A0 in X=A/Y=B mode
ACQB0 ... ACQB7		A7		Acquisition output bits 0 ... 8
AVSB		A13		Logic 0 in X=A/Y=B mode
D0 ... D7	DO ...D7	A4-A6		Data bits from system data-bus
DAT		A4		Data selection-
FASDI		A13		Phase on display level
INV		A4		Signal invert
IO4		A4		Data RAM select
		A6	A20	Output enable RAM0
	OER1	A6	A20	output enable RAM1
	OER2	A6	A20	Output enable RAM2
	OER3	A6	A20	Output enable RAM3
PON		A4		Power on
RD		A4		Signal READ from microprocessor
SOD		A4		Microprocessor serial output data
WR		A4		Signal WRITE from microprocessor
	X DAC	A6	A20	Horizontal DAC output signal
	Y DAC	A6	A20	Vertical DAC output signal
	ZOVL	A6	A4	Z overflow signal
+5 V		A15		
+5 BATT		A15		
+12 V		A15		
-12 V		A15		

Fig. 6.2.18.

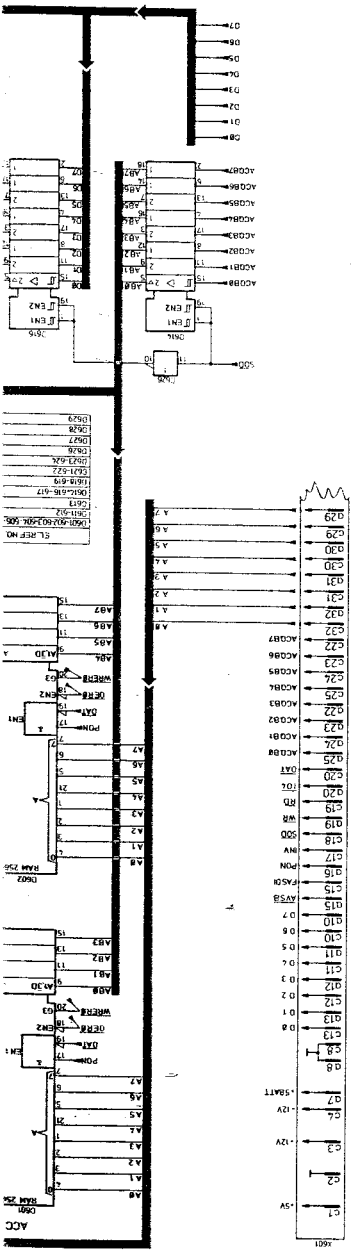
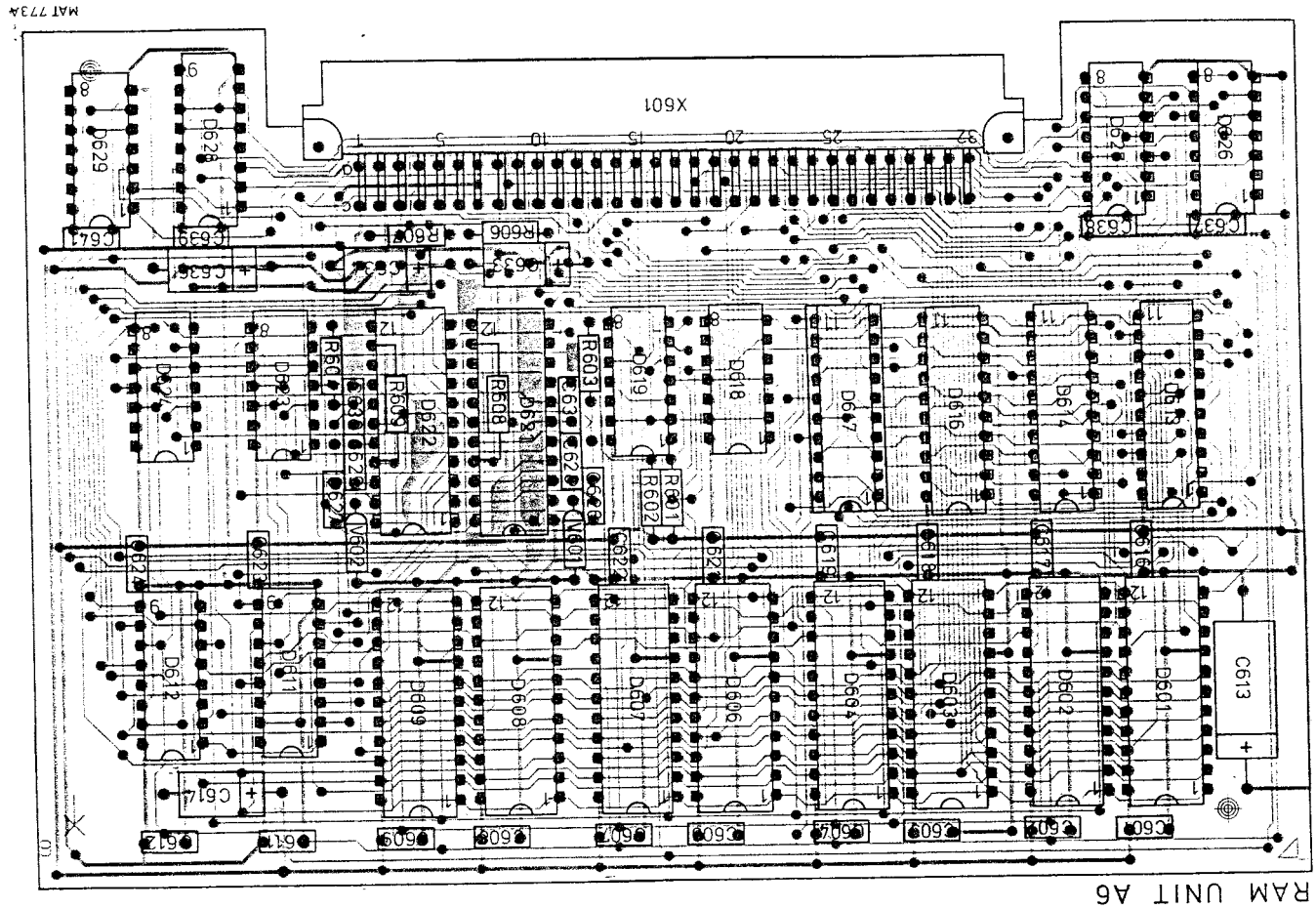

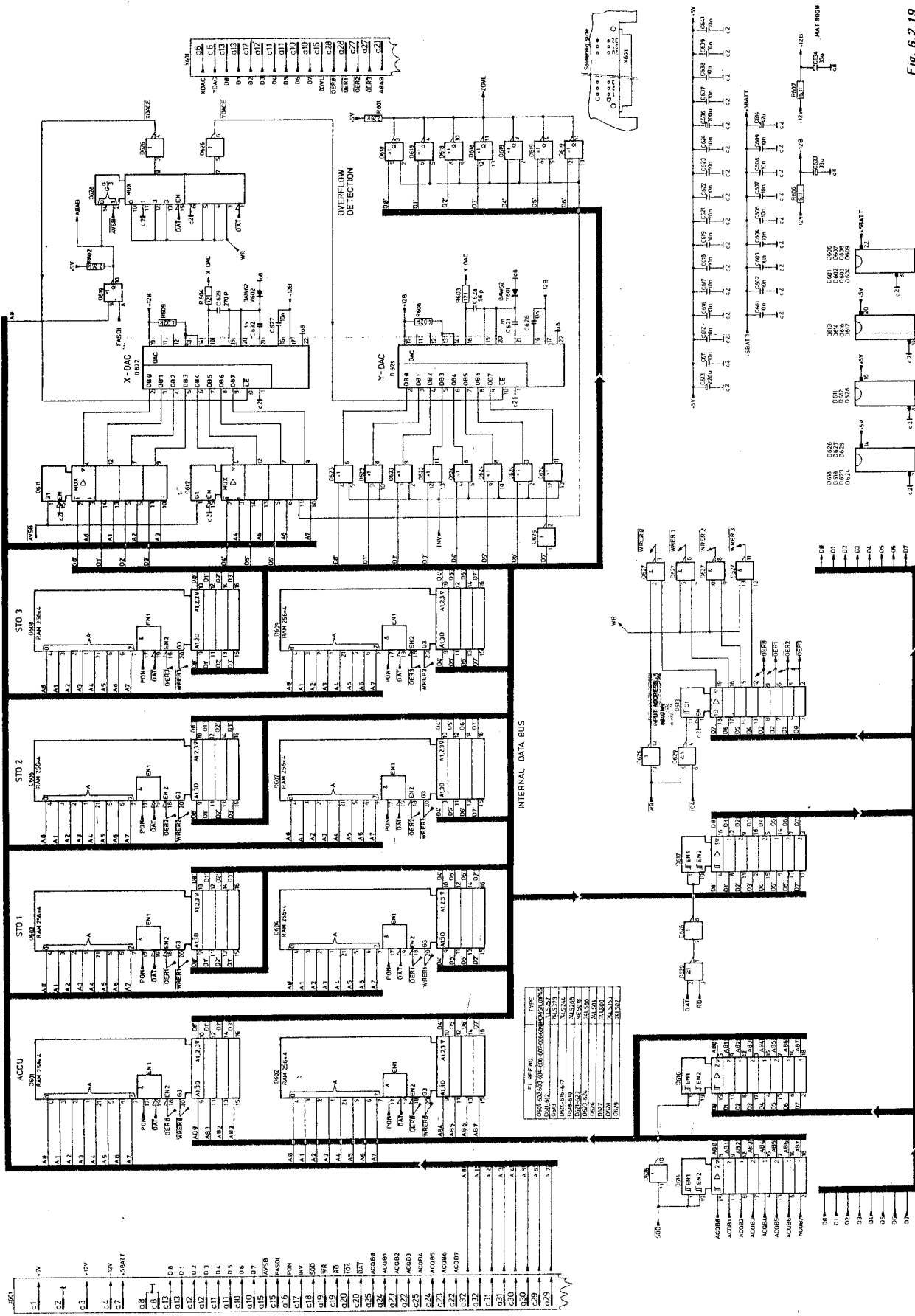

Fig. 6.2.19.

A6 RAM UNIT

6-72

6.2.7. Buffer unit A7

6.2.7.1. General

The buffer unit consists of a 9-bit x 256 digital shift register for data storage and a digital-to-analog converter DAC M-1, which re-converts the digital output signals from the ADC for the correction of subsequent analog signals.

Analog information from the acquisition section of the oscilloscope is converted into a 9-bit digital value ADCB0 ... ADCB8 on the conversion unit. After conversion and final correction, these signal bits are shifted into the 9-bit x 256 digital shift register D701 ... D711 on this buffer unit, for storage. The contents of this shift register are only shifted under the control of a clock signal CLKSH, generated in D718, D719.

$$CLKSH = (INS.NDR) + (SOD.WR)$$

Shifting can be interrupted therefore by blocking signal CLKSH.

The nine shift register output signals will only be applied to the ACQB bus in the P2CCD-mode (signal P = logic 1) for correction purposes or if signal NDR = logic 1 (new data is available). Data is applied to the ACQB bus via the 3-state non-inverting buffers D716 and D717.

6.2.7.2. Data routing and correction in P2CCD mode

For details of this, refer to the Conversion Unit A8 description.

6.2.7.3. Data routing and correction in DRS-mode

In the DRS-mode (Direct, Roll and Sample), inaccuracies of the Track/Hold circuit and the ADC circuit are corrected before the information is stored in the shift register. The circuit is operative for dual-channel mode working, i.e. with both channel A and channel B switched on. This mode is arranged to function automatically even if only one channel is selected.

Principle of operation

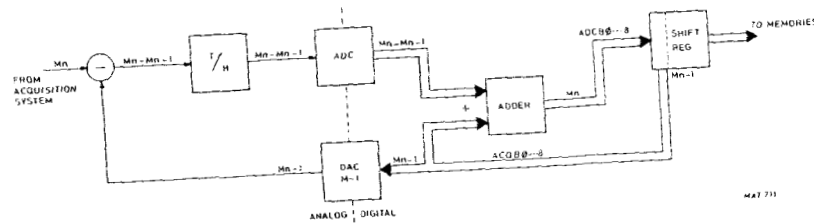

Fig. 6.2.20

To reduce errors in conversion, analog samples for digitising are compared with preceding samples, these being subtracted so that only small increments are converted to digital values in the ADC. After conversion, the digital equivalent of the original analog signal is produced by adding the differential signal from the ADC to the digital value of the preceding sample.

Referring to the block diagram,  $M_n$  is the new sample of the input signal from the acquisition system;  $M_{n-1}$  is the preceding sample, derived from the shift register and re-converted by DAC M-1 to analog form. At the input to the Track and Hold circuit,  $M_n$  is subtracted from  $M_{n-1}$  to produce a differential analog voltage, which is then converted to digital form in the ADC and added to the preceding digital value  $M_{n-1}$ .

$$\text{i.e. } (M_n - M_{n-1}) + M_{n-1} = M_n$$

After this procedure, the adder output value  $M_n$  will be shifted into a shift register as a new and corrected value. This system of digital adding is also used, in a different way, in the P2CCD-mode as described in the Conversion Unit A8.

Detailed description

This digital adding technique is now described in greater detail with reference to the various circuit elements. The analog value of the preceding signal sample  $M_{n-1}$  is subtracted from the new sample  $M_n$  in the vertical amplifier stage. This results in a differential analog voltage  $M_n - M_{n-1}$ , which is converted to digital signals ADCB0 ... ADCB8 and applied to the adder circuit on unit A8 together with the preceding sample  $M_{n-1}$  in digital form.

After adding overflow detection and marking, the sum signal  $M_n$  is applied as ADCB0 ... ADCB8 to the shift register on the buffer unit A7. With this new signal value stored in the shift register, the circuit continues with the next.

The corrected sample value  $M_n$  on the ADCB lines from the conversion unit A8 to the shift register is also applied to the 4-bit latches 0712 and stored under the control of signal C0. The output signals from the latches are applied to the digital-to-analog converter DAC (M-1) 0714.

In the P-mode, the DAC (M-1) circuit is switched off by the P signal on the input pin 10. However, in the DRS-mode the DAC (M-1) circuit is switched on. The most-significant bit of the 8-bit 2's complement information offered to the DAC (M-1) is inverted by D719 (4,5) to translate the data into 8-bit straight binary notation. Conversion by DAC (M-1) results in the analog value of the preceding digital sample  $M_{n-1}$  and this value is fed back to the vertical amplifier stage for subtraction from the new signal sample  $M_n$ .

In the amplifier stage, analog subtraction will result in a new differential voltage as previously described. This differential voltage  $M_n - M_{n-1}$  is then converted to digital in the ADC and added to the old digital value  $M_{n-1}$ . The old digital value that was stored in the two 4-bit latches 0712 is in the meantime shifted to the next two 4-bit latches 0713 by control signal C4 and fed to the adder circuit. Here, the 8-bit 2's complement notation is converted into a 9-bit ACQB0 ... ACQB8 digital form by copying the last bit. Data from one signal source only may be fed to the ACQB bus by more than one buffer simultaneously. This is made possible by signals P and NDR via NOR-gate D718 (4,5,6) and inverter D719 (2,3). Each time an NDR pulse is generated, the total shift register contents will be copied into the ACCU memory. Precise timing diagrams are given in the ACL Unit A9 description.

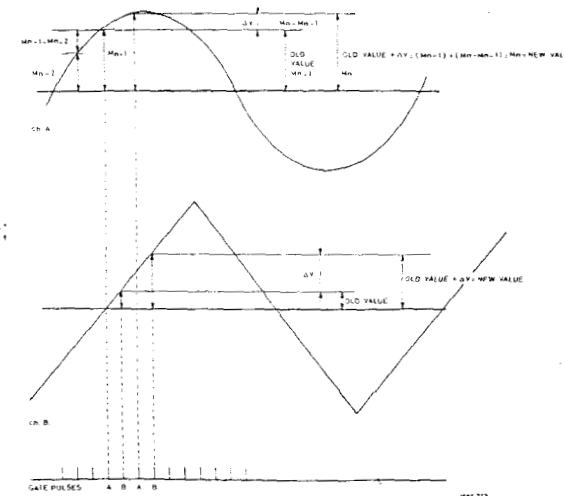
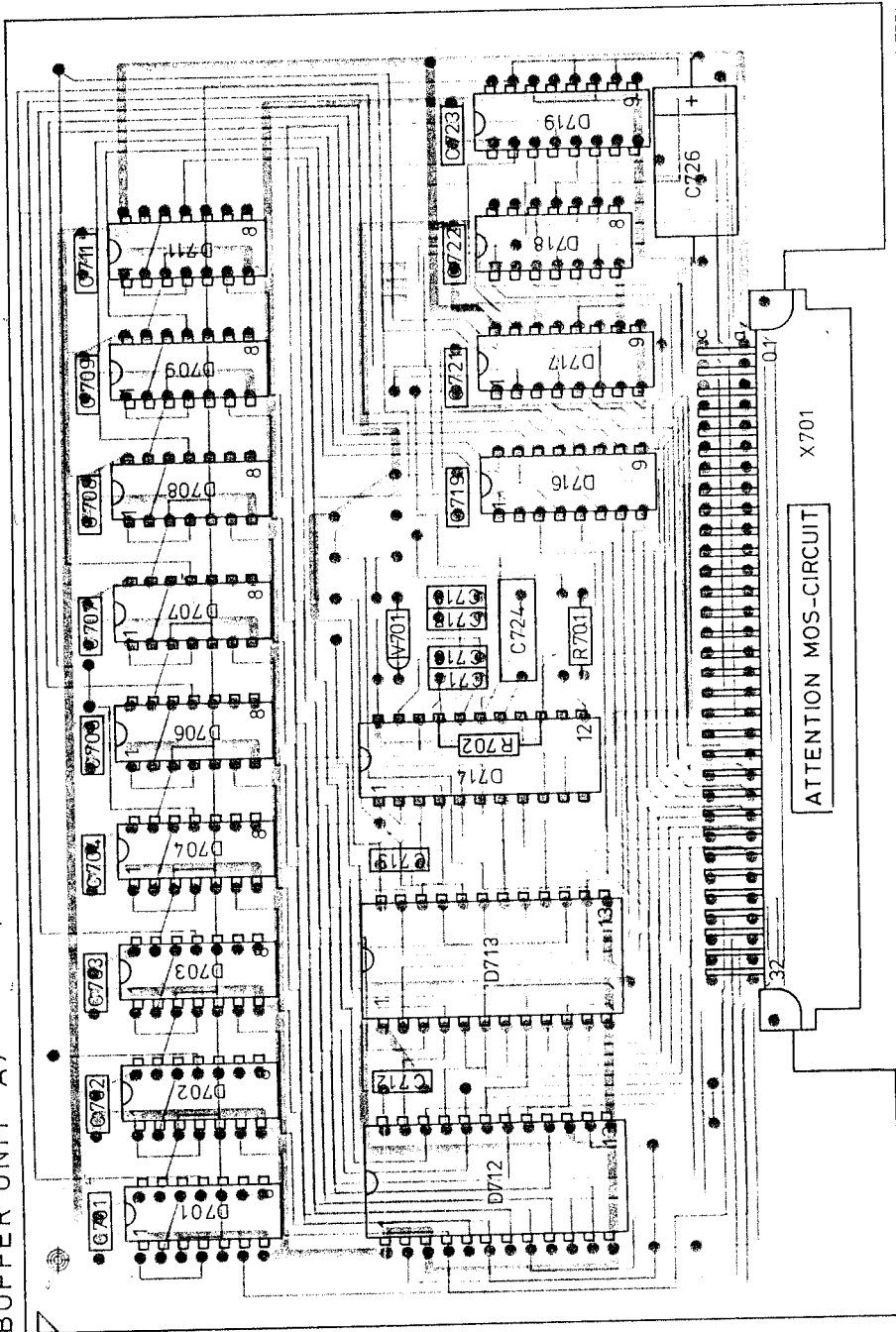

Fig. 6.2.21.

INCOMING SIGNALS	OUTGOING SIGNALS	GENERATED ON UNIT	USED ON UNIT	DESCRIPTION
	ACQB0 ... 8	A7 A8 A9	A6-8	Acquisition output bits 0 ... 8 ADC bits
ADC80 ... 8		A9		Control 0 signal from ACL unit
C0		A9		Control 4 signal from ACL unit
C4	CLKSH	A7		Clock pulse for shift register
	DACM 1	A7	A21	DAC M-1 output signal
INS		A9		Shift command for shift register
NDR		A9	A4	New data ready
P		A12	A7-8-9-10	P mode signal
SOD		A4		Microprocessor serial output data
	SOD	A7	A?	Microprocessor serial output data
WR		A4		Signal write from microprocessor
+5 V		A15		
+12 V		A15		
-12 V		A15		
I		A15		

BUFFER UNIT A7



MAT774

Fig. 6.2.22.

A0C8B1  
 A0C8B2  
 A0C8B3  
 A0C8B4  
 A0C8B5  
 A0C8B6  
 A0C8B7  
 A0C8B8  
 A0C8B9

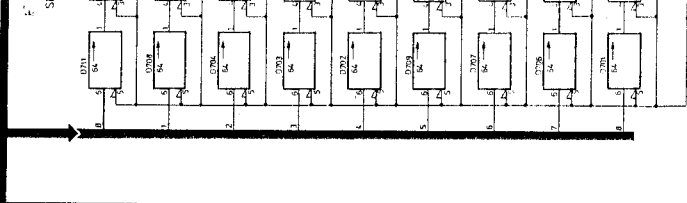

01	-5V
02	-12V
03	-12V
04	-12V
05	P
06	CE
07	CE
08	CE
09	CE
10	CE
11	CE
12	CE
13	CE
14	CE
15	CE
16	CE
17	CE
18	CE
19	CE
20	CE
21	CE
22	CE
23	CE
24	CE
25	CE
26	CE
27	CE
28	CE
29	CE
30	CE
31	CE
32	CE
33	CE
34	CE
35	CE
36	CE
37	CE
38	CE
39	CE
40	CE
41	CE
42	CE
43	CE
44	CE
45	CE
46	CE
47	CE
48	CE
49	CE
50	CE
51	CE
52	CE
53	CE
54	CE
55	CE
56	CE
57	CE
58	CE
59	CE
60	CE

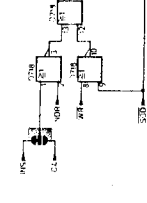

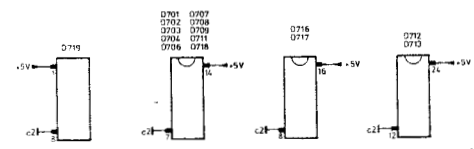
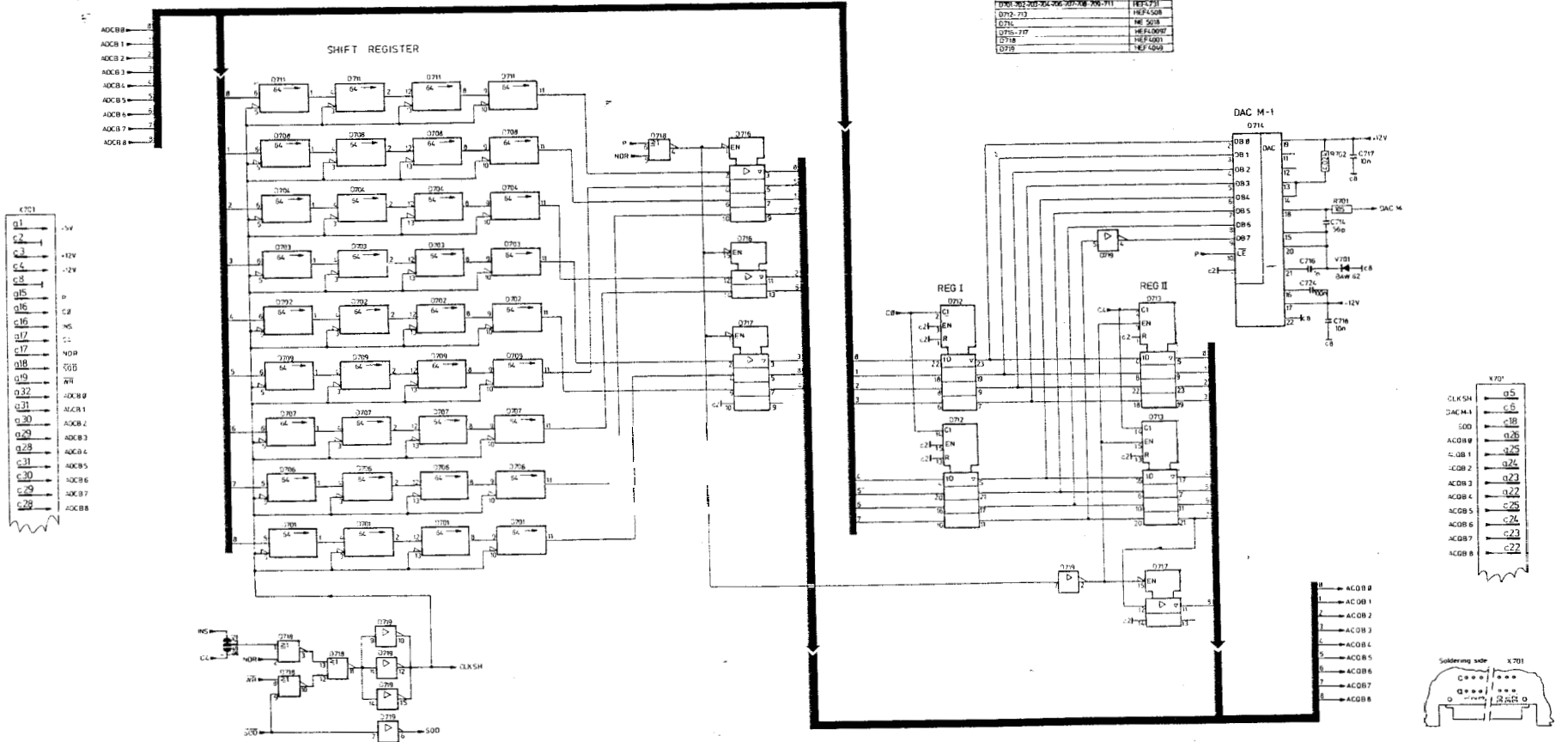
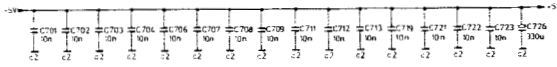

A7 BUFFER UNIT

Fig. 6.2.23.

MAT 804

MAT 774

g. 6.2.22.

6.2.8. Conversion unit A8

The conversion unit basically consists of an ADC for converting the input signals into digital form for storing in the shift register on the buffer unit A7, a circuit for signal zero correction, and an overflow detection and marking circuit.

These functions are performed by the following circuit blocks:

- a sample and hold circuit for analog inputs, D822
- analog-to-digital converter (ADC) D821
- AND-gates D801, D813 for controlling inputs to the adder circuit
- exclusive-OR gates D802, D814, D809 for inverting signal to adder for subtraction during correction
- adder circuit D803, D816, D804
- multiplexers D806, D807, D817, D818 on adder outputs for overflow detection, marking, etc.
- result registers D819, D811 for storing multiplexer output signals.

6.2.8.1. Sample and Hold circuit

Analog output signal VOUT from the CCD logic unit (A10), which represents the A and/or B channel input signals in one of the selected modes, is applied to input 3 of the sample and hold circuit D822. This circuit is controlled by the TRACK signal:

- TRACK = logic 1 - the circuit only tracks the input signal
- TRACK = logic 0 - (= HOLD) the circuit holds the input level that was present at the negative-going edge of the TRACK signal

The output signal of this sample and hold circuit D822 provides an input to the ADC that lies between +5 V and -5 V.

6.2.8.2. Analog-to-digital converter(ADC)

The analog input level from the sample and hold circuit is converted into a digital 9-bit number in the ADC circuit D823. Conversion is controlled by the clock pulses CLADC. (Nine clock pulses are used to convert to this 9-bit number) As the ADC is a 10-bit type, the least-significant bit being ignored. These clock pulses are only generated by the ACL unit A9 during the period when the CONV signal (conversion) is at logic 1.

The ADC output signal CONV reverts to logic 0 at the end of the conversion period, thus indicating that conversion is complete and that the results can be fed to the ADCB0 ... ADCB8 bus via the tri-state non-inverting buffers D811, D812:

The 9-bit digital output of the ADC is straight binary coded and is converted to 2's complement notation in exclusive-OR gate D809 (11,12,13) by inverting the most-significant (9th) bit, as shown in the following table.

STRAIGHT BINARY 19-bit		2's COMPLEMENT(9-bit)		
	Decimal		Decimal	
-5 V	+0	0 0 0 0 0 0 0 0 0	-256	1 0 0 0 0 0 0 0 0
		0 1 0 0 0 0 0 0 0	-255	1 0 0 0 0 0 0 0 1
		0 1 0 0 0 0 0 0 0	-128	1 1 0 0 0 0 0 0 0
		0 1 1 1 1 1 1 1 1	-1	1 1 1 1 1 1 1 1 1
		1 0 0 0 0 0 0 0 0	+0	0 0 0 0 0 0 0 0 0
+5 V		1 0 1 1 1 1 1 1 1	+127	0 0 1 1 1 1 1 1 1
	+511	1 1 1 1 1 1 1 1 1	+255	0 1 1 1 1 1 1 1 1

INVERSION OF THE 9th BIT

The 2's complement equivalent value is fed to the ADCB bus-lines by the tri-state non-inverting buffers D811, D812 under the control of signal C1. With C1 at logic 1, the buffers are in 3-state mode.

Signal input C1 is a control line which, together with signal C2 prevents simultaneous input of data to the bus-lines by more than one buffer.

6.2.8.3. Correction circuits

As the correction circuits operate in conjunction with other circuits that are not part of the conversion unit A8, the data routing and the principles of correction in the P2CCD-mode are first discussed.

Data routing and correction in the P2CCD-mode

Due to internal P2CCD faults and differences between the frequencies  $f_{in}$  and  $f_{out}$ , an incorrect zero level of the P2CCD output signal is possible as shown in the following graph.

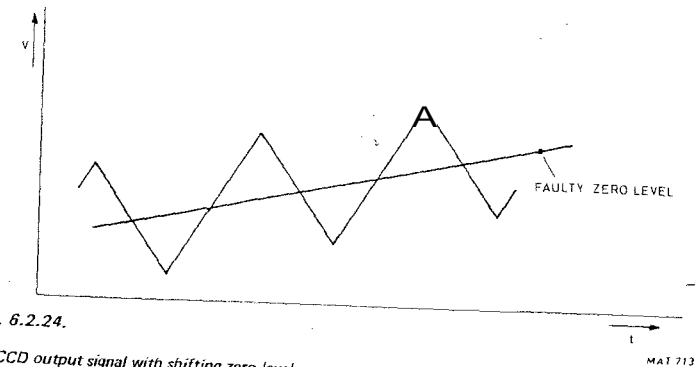

Fig. 6.2.24.

P2CCD output signal with shifting zero level

Under these conditions, the total faulty contents of the P2CCD are converted from analog form to digital in 256 steps and after each conversion the data is put on the ADCB0 ... ADCB8 bus and directly shifted into the 9-bit shift register on buffer unit A7. After 256 steps, the total P2CCD contents are stored here, and the register is then blocked.

In order to correct the zero level, the P2CCD input is switched to zero and 256 samples of this zero signal are shifted into the P2CCD at the same frequency  $f_{in}$  as for the normal input signal.

By reading the P2CCD contents again, with the same frequency  $f_{out}$  (78 kHz) as for the faulty input signal, an incorrect zero level having the same errors as described above will appear on the P2CCD output as shown below.

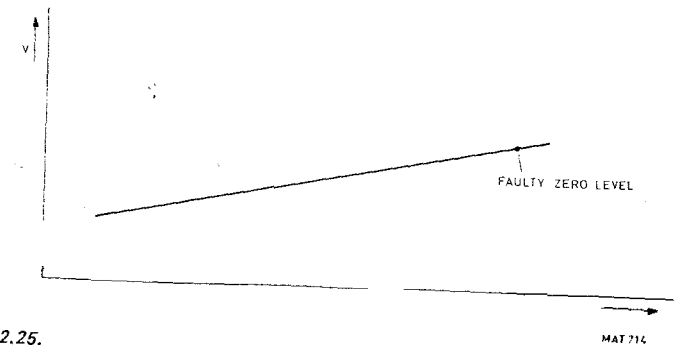

Fig. 6.2.25.



This incorrect zero level is then digitally subtracted (in 256 steps) from the faulty input signal, which was already stored in the shift register.  
The corrected result is then re-stored in the shift register.

**Correction circuit description**

Considering the correction circuits in more detail, the correction cycle is started when the P<sup>2</sup>CCD is completely filled with zero samples. This is done in 256 steps, in which for every step, one sample of faulty input information from the shift register, and one converted zero sample from the P<sup>2</sup>CCD are applied to an adder circuit on this conversion unit (A8), consisting of the integrated circuits 0803, 0816 and D804.

The procedure is as follows:

- The shift register contents are placed byte after byte on the ACQBB ... 8 bus via a buffer and directly applied to the inputs of the adder circuits.
- The samples of zero information from the P<sup>2</sup>CCD are placed on the ADCB0 ... 8 bus, sample after sample in the same way as described for the uncorrected signal information. However, in this case it is not shifted into the shift register but is transferred via AND-gates D801, D813 and exclusive-OR gates D802, D814 and D809 (4,5,6) to the adder circuit. For correct overflow detection and marking, hit 9 is copied and applied to the adder as bit 10.

(During the copying of the shift register contents into the ACCU memory in ROLL-mode, one side of the adder input is blocked via AND-gates D801, D813 by the NDR signal to permit recirculation of the shift-register contents.)

The exclusive-OR circuits serve to invert the zero information so that it can be subtracted from the signal information. The subtraction process is performed by inverting the zero information and adding it, together with a forced carry, to the signal information from the shift register.  
The forced carry is obtained by signal P on input 9 of adder circuit D803.

At the output of the adder, the corrected signal samples appear one by one and are transferred to the overflow detecting and marking circuits (multiplexers D806, D807, D817, D818).  
The ACCU memory, and thus the c.r.t. display, is 8-bit wide; therefore the corrected adder output signals, which can be 10-bit wide, are checked for overflow. Consequently, if overflow occurs, this condition will be indicated and overflow marking is necessary.

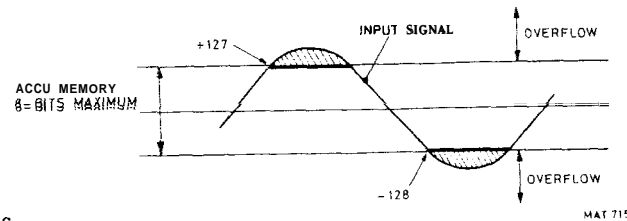

Fig. 6.2.26.

Marking is carried out by changing the signal value during overflow in one of the digital values +127 or -128, via the multiplexers 0806, D807, 0817, D818.

These multiplexers are controlled by the adder output bits ADOB7, ADOBE, ADOB9, which give information about overflow.

AD089	ADOB8	ADOB7	MULTIPLEXER OUTPUT
0	0	0	ADDER OUTPUT
0	0	1	+127
0	1	0	+127
0	1	1	NON-EXISTING COMBINATIONS
1	0	0	
1	0	1	-128
1	1	0	-128
1	1	1	ADDER OUTPUT

In case of an overflow, signal ADOB9 indicates whether it is an overflow or an underflow. ADOB8 and ADOB7 together indicate whether there is an overflow condition.  
After marking, the multiplexer output signals are stored in the result register D819 under the control of C3. These output signals are applied to the bus ADCB0 ... 8 via D819 and D811 when signal C2 is logic 0. C2 = 1 indicates that the buffer outputs are in tristate.  
At the same time, the last hit is copied to reestablish a correct 9-bit 2s complement notation.

The data placed on the bus in this way are the corrected samples and are shifted again into the shift register. After 256 correction steps the shift register contains the complete corrected signal.

Signal NDR (new data ready) now reverts to logic 1 and the shift register contents are copied into the ACCU memory under the control of the microprocessor and its software.

The contents of the shift register are copied into the ACCU memory including the overflow markings +127 or -128. The overflow markings are detected by hardware when the contents of the ACCU are required to be displayed on the c.r.t. screen. This results then in a flashing trace on the c.r.t. screen to indicate this overflow. The same is possible if the ACCU-memory contents are saved in one of the memories ST01 - ST02 or ST03.

Signal CLR enables zeros to be placed on the bus to reset the shift register contents in case of ACCU-memory clearing.

**Data routing and correction in DRS mode**

Refer to description of buffer unit A7

Note: For timing diagrams and explanation of timing refer to the description of the ACL unit A9.

INCOMING SIGNAL	OUTGOING SIGNAL	GENERATED ON UNIT	USED ON UNIT	DESCRIPTION
ACQBB ... ACQB8	ADCB0 ... 8	A7	A7	Acquisition output bits 0 ... 8
C1		A8		ADC output signals bit 0 ... bit 8
C2	CONV	A9	A9	Control 1 signal from ACL unit
c3		A9		Control 2 signal from ACL unit
CLADC		A9		Control 3 signal from ACL unit
CLR	CONV	A4	A9	Clock signal for ADC
CLR		A8		Clear signal for shift register
NDR	CONV	A9	A9	Conversion
P		a12		New data ready P <sup>2</sup> CCD-mode
SOD		A7		Microprocessor serial output data
TRACK		A9		Track command from ACL unit
VOUT		A10		CCO logic unit analog output signal
WR		A4		Signal WRITE from microprocessor

CONVERSION UNIT A8

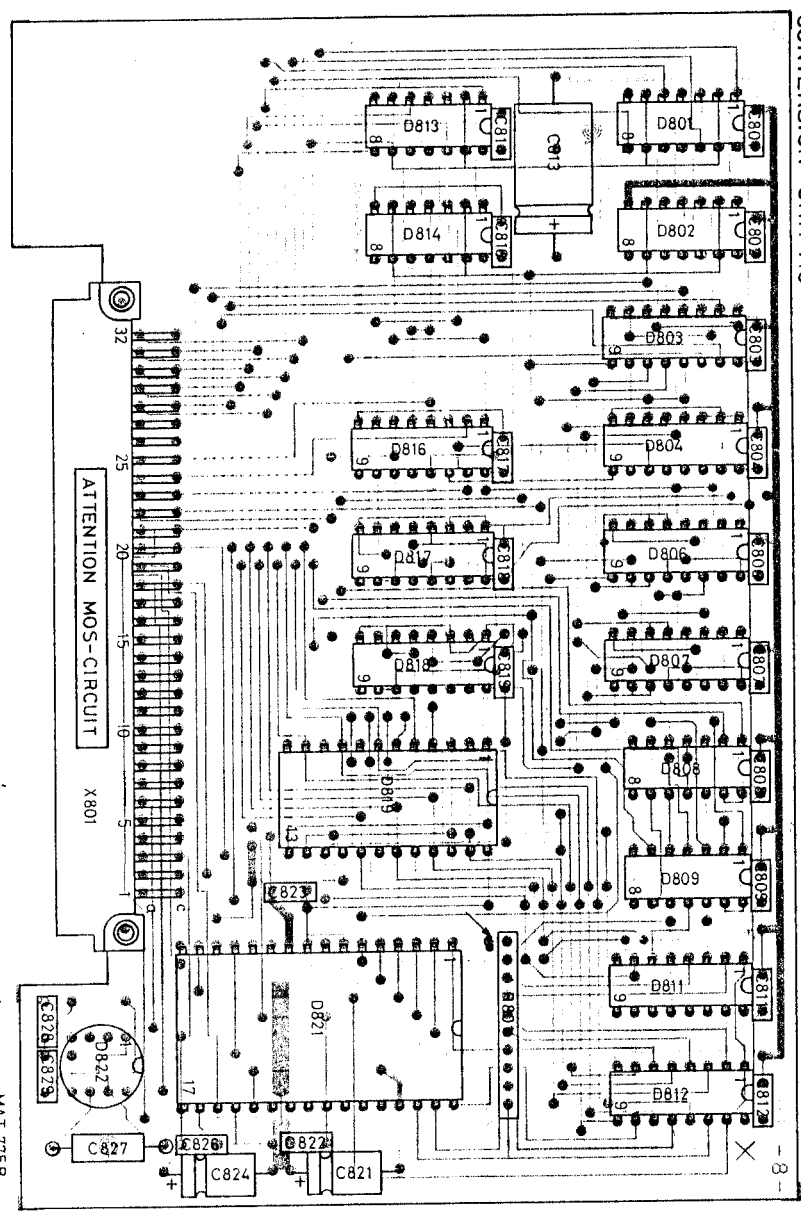
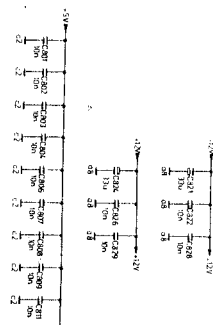
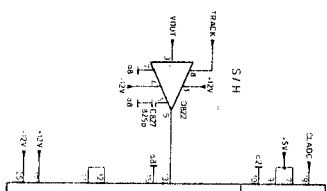
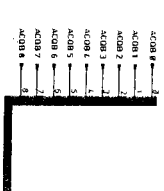

Fig. 6.2.27.

C1	100	100
C2	100	100
C3	100	100
C4	100	100
C5	100	100
C6	100	100
C7	100	100
C8	100	100
C9	100	100
C10	100	100
C11	100	100
C12	100	100
C13	100	100
C14	100	100
C15	100	100
C16	100	100
C17	100	100
C18	100	100
C19	100	100
C20	100	100
C21	100	100
C22	100	100
C23	100	100
C24	100	100
C25	100	100
C26	100	100
C27	100	100
C28	100	100
C29	100	100
C30	100	100
C31	100	100
C32	100	100
C33	100	100
C34	100	100
C35	100	100
C36	100	100
C37	100	100
C38	100	100
C39	100	100
C40	100	100
C41	100	100
C42	100	100
C43	100	100
C44	100	100
C45	100	100
C46	100	100
C47	100	100
C48	100	100
C49	100	100
C50	100	100
C51	100	100
C52	100	100
C53	100	100
C54	100	100
C55	100	100
C56	100	100
C57	100	100
C58	100	100
C59	100	100
C60	100	100
C61	100	100
C62	100	100
C63	100	100
C64	100	100
C65	100	100
C66	100	100
C67	100	100
C68	100	100
C69	100	100
C70	100	100
C71	100	100
C72	100	100
C73	100	100
C74	100	100
C75	100	100
C76	100	100
C77	100	100
C78	100	100
C79	100	100
C80	100	100
C81	100	100
C82	100	100
C83	100	100
C84	100	100
C85	100	100
C86	100	100
C87	100	100
C88	100	100
C89	100	100
C90	100	100
C91	100	100
C92	100	100
C93	100	100
C94	100	100
C95	100	100
C96	100	100
C97	100	100
C98	100	100
C99	100	100
C100	100	100





6.2.9. Acquisition control logic unit A9

6.2.9.1. General

Before discussing the timing functions in the various operating modes, the general circuit functions of the Acquisition Control Logic unit are first outlined. The ACL unit contains the timing circuits that generate the signals required to control the conversion unit (A8) and the buffer unit (A7).

A Hold and Convert pulse HOCON starts each analog-to-digital conversion of an input signal sample. In the P-mode, this is signal HOCON P from the CCD logic unit A10; in the Direct Roll and Sampling modes, this is HOCON DRS from the trigger unit A22.

Depending on the mode selected, one of these hold and convert signal lines is applied to the clock input of D-type flip-flop D909 via multiplexer D911, pin 7. This multiplexer is controlled by the signals P and R, to give the following.

SIGNALS		D911 output pin 7
R	P	
0	0	HOCON DRS
0	1	HOCON P
1	0	HOCON DRS
1	1	(unavailable input signal combination)

Flip-flop D909 is switched by the HOCON pulse, resulting in the TRACK signal going to logic 0, which brings the Track and Hold circuit on the conversion unit to the HOLD state.

Analog-to-digital conversion is now started and controlled by the nine clock pulses CLADC (pin 11 of NAND-gate D906), which are derived from a 1.25 MHz clock signal. During conversion in the ADC, a signal CONV is at logic 1. After conversion, this signal goes to logic 0, indicating that conversion is finished. Output pin 6 of flip-flop D909 is now switched to 0 by the CONV signal and this zero resets the other two flip-flops in the circuit (RESET inputs D908-12, D909-13). In this way, the CONV signal blocks the CLADC pulses again and switches the TRACK signal. The track and hold circuit now returns to tracking the input signal.

The CHOP output of chopper flip-flop D908 is switched to its opposite state at the end of each conversion by signal CONV on its clock input. Only in the P-mode, where the CHOP signal is not required, is the chopper flip-flop set permanently to its '1'-state, i.e. signal CHOP is logic 1. This is achieved by a zero level on the direct set input of the flip-flop.

During each conversion, a C0 pulse on D906-8 is fed from the CONV signal to control the first buffer stage (D712 on unit A7) after the adder circuit (on unit A8). This is the buffer stage that sends its data to the digital-to-analog converter DAC (M-1).

At the completion of each ADC conversion, counter D928, which has been preset to the value 15, starts counting the 1.25 MHz pulses on its clock input.

The start of counting is initiated by the output signal of flip-flop D927, which is set to logic 1 by the positive-going edge of the CONV signal.

	OD	OC	OB	OA
15	1	1	1	1
0	0	0	0	0
1	0	0	0	1
2	0	0	1	0
3	0	0	1	1
4	0	1	0	0
5	0	1	0	1
6	0	1	1	0
7	0	1	1	1
15	1	1	1	1

The first counting pulse results in counter-state 0. Output signals OA, OB, OC and OD are applied to a BCD/10 decoder, D923.

Control pulses C3 and C4 are derived directly from decoder outputs 3 and 4 respectively. The C3 pulses are only present whenever there is no new data ready, i.e. if NDR = logic 1.

After state 7 of the counter, a logic 0 on output pin 9 of the decoder is fed back to the direct reset input of flip-flop D927 to switch it to its zero state. Thus the count pulses for the counter are blocked and it is again preset by the value 15. From the same decoder output signal a COUNT pulse is given via flip-flop D913, which is switched as a normal inverter. One COUNT signal is generated for each ADC conversion and so provides a means of counting the number of conversions.

Control pulses C1, C2 (C1 inverted) and INSP are generated by multiplexer D921 controlled by the NDR and PN signals.

CONTROL SIGNALS		OUTPUT SIGNALS	
NOR	PN	C1	INSP
0	0	OC	INSR
0	1	OV	C3
1	0	+5 V	+5 V
1	1	+5 V	+5 V

Signals C1 and INSP are permanently at logic 1 during NDR. Therefore, during copying the contents of the shift register into the ACCU memory, the buffer following the ADC circuit will be set in its tri-state, i.e. no AOC output data can be sent either to the adder or to the shift register circuit.

Signal C1 will be at logic 1 when uncorrected signal information has to be shifted into the shift register in the P-mode (PN at logic 1). This allows the information to be shifted directly into the register. The shift command INSP is in this situation derived from signal C3. In the DRS modes and during zero correction in the P-mode, C1 and also C2 signals are derived from counter output OC. These signals control the AOC output buffer and the adder output result register (D819 on unit A8) so that only one of the two can output data on to the ADCBQ ... 8 bus at any given time.

In the DRS modes, and during zero correction in the P-mode, the INSP signal is derived from decoder output signal INSR. Therefore, INSP is generated after the correction result is put in the result register and the register output data is fed to the ADCBQ ... 8 bus.

6.2.9.2. Timing in P-mode

Flip-flop D913 is set to logic 1 by a trigger pulse OELTRG in normal trigger mode and by AUTRI in the AUTO mode, both signals being generated by the delayed trigger unit (A13).

After receiving a trigger signal, the NULIN signal goes to logic 1. This signal is applied to the vertical amplifier unit A21 to block the amplifier channels so that a zero level is offered to the P<sup>2</sup>CCD inputs.

A signal FOE (frequency output enable) also goes to logic 0 (assuming that pin 10 of D914 is at logic 1) to indicate to the CCD logic unit that the P<sup>2</sup>CCD contents can be read with a clock signal of 78 kHz approx. This will result in HOCON P pulses to start ADC conversions.

The COUNT signals generated at each conversion are counted by the 10-bit acquisition control logic counter consisting of two flip-flops D924 and two 4-bit counters D918 and D917.

This counter, which was in its reset state in the preceding P-mode cycle, is now enabled for counting. Signal NULIN switches, via multiplexer D916, the flip-flop D902 so that the counter is no longer held in its reset state and is ready to receive count pulses. Signal FOE sets the multiplexer D926 so that the COUNT pulses on input 12 appear at output 9. These COUNT Pulses are applied to the counter and after 256 have been counted the entire P<sup>2</sup>CCD contents are read, digitised and shifted into the shift register. Counter state 256 is indicated by a logic 1 on pin 12 of D917. This signal switches FOE to logic 1 via inverter D919 and NAND-gate 0914 to stop the P<sup>2</sup>CCD read cycle.

A cycle now starts in which the P<sup>2</sup>CCD is completely filled with zero information, using the same frequency for shifting as that for reading in the input signal information. Signal FOE now switches multiplexer 0926 to the state where the 50 kHz signal on pin 13 is coupled to the input of the counter. Counting continues up to 512 and in the meantime, zero information is shifted for about 5 msec into the P<sup>2</sup>CCD via the NUL IN signal in the vertical amplifier unit 1256 x 0.02 msec is approximately 5 msec). When the counter reaches 512, output 12 of D917 returns to logic 0 and also signal FOE = logic 0. Now a cycle starts in which the zero contents of the P<sup>2</sup>CCD are read and digitised in 256 steps at a clock frequency of approximately 78 kHz. At every step, one sample of uncorrected information in the shift register is corrected by a zero sample from the P<sup>2</sup>CCD and the result shifted again into the register. After 256 corrections the total corrected signal is present in the shift register. At the end of the correction cycle, the state 768 (512+256) of the counter is detected by NAND-gate D914 (11,12,13), which results in a logic 0 on output pin 11.

This signal is fed to output pin 9 of multiplexer D916 and causes flip-flop 0902 to switch to its zero state. The output signal on pin 9 of 0902 prepares the reset of two synchronous counters with synchronous clear, D918, D917. These can now be reset by a pulse on the clock input, which is derived from a 1.25 MHz clock signal via D926 and D924. The clock signal can pass through multiplexer D926 because of the low level of the output signal on pin 9 of D916, which is applied to input 2 of D926.

After the reset of counters D918 and D917, the output pin 3 of NAND-gate D914 goes to logic 0 via the multiplexer and NAND-gate D914 (11,12,13). This signal resets the two flip-flops 0924 of the acquisition control logic counter. The entire counter is now in the reset state and remains in this state until the next NUL IN signal is generated.

At the end of the correction cycle, the positive-going edge of the signal on output 8 of flip-flop D902 will, via multiplexer D901, switch NDR flip-flop D902 to its logic 1 state. Signal NDA is applied to the SID input of the microprocessor on unit A4 to indicate that new data is ready and can be copied by the ACCU memory.

After a certain time, the microprocessor reacts by generating a logic 1 on its SOD output and 256 WR pulses followed by a logic 0 on its SOD input. During the SOD signal the shift register contents are copied into the ACCU memory in 256 steps controlled by the WR pulses from the microprocessor.

Trigger flip-flop D913 is then brought to its reset state by signal CTF, which is derived from signal NDR via multiplexer D901

The whole system can react again on incoming trigger pulses at the end of the 'handshake' cycle.

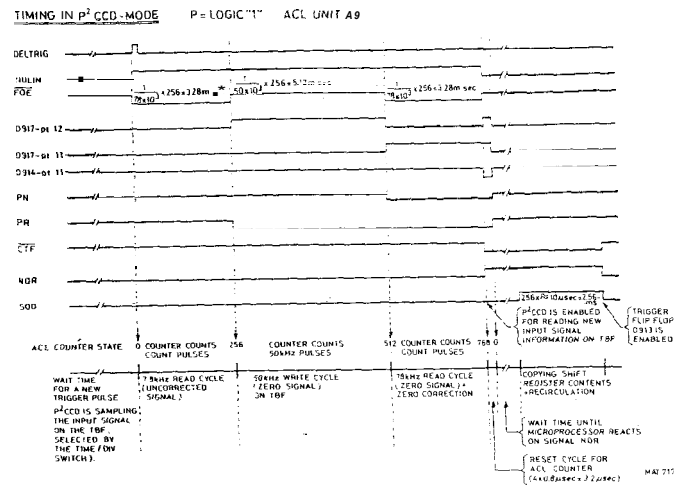

Fig. 6.2.29

Flip flop NDR is then reset by the positive-going edge of the SOD signal via the flip flop consisting of NAND gates D903, and signal CTF goes to logic 1 so enabling trigger flip flop 0913 again

The NDA signal will also be generated while the CLEAR button on the front panel is operated. Signal CLR is then a logic 0.

6.2.9.3 Timing in Direct mode

In the Direct mode the flip-flop 0913 is switched to logic 1 by a trigger pulse DELTRG in normal trigger mode and by SOD in the AUTO mode, both signals being generated by the delayed trigger unit (A13)

On receipt of a trigger, flip-flop 0913 is switched and applies a logic 1 to the D-input of NDR flip-flop D902 via NAND-gate D903 (1,2,3). The NOR flip-flop switches to logic 1 at the first COUNT pulse on its clock input (received via multiplexer D901). This commences an NDR cycle to copy the shift register contents into the ACCU memory in the way already described for the P-mode.

The NDR flip-flop is reset by the positive-going edge of the SOD signal via the flip-flop comprising NAND circuits 0903. Simultaneously, the acquisition control logic counter starts counting 256 COUNT pulses. This start is initiated by the NDR signal on the clock input of flip-flop D902, received via multiplexer D916. At this same start time, a logic 0 on output 8 of flip-flop D902 causes output CTF of multiplexer 0901 to go to logic 0. This results in a reset of the trigger flip-flop D913.

The acquisition control logic counter counts up to state 256. This state is decoded, resulting in a logic 1 on pin 12 of counter D917, which is applied via inverter D919 (8.9) and multiplexer D916 to flip-flop 0902.

The counter is then reset in the way described for the P-mode.

At this moment, it is established that at least 256 new samples of the input signal are stored in the shift register, so the total shift register contents are refreshed (i.e. a type of trigger hold-off).

Resetting the acquisition control logic counter results in signal CTF going to logic 1, thus again enabling the trigger flip-flop D913.

This prepares the flip-flop to receive another trigger to start a new D-mode cycle.

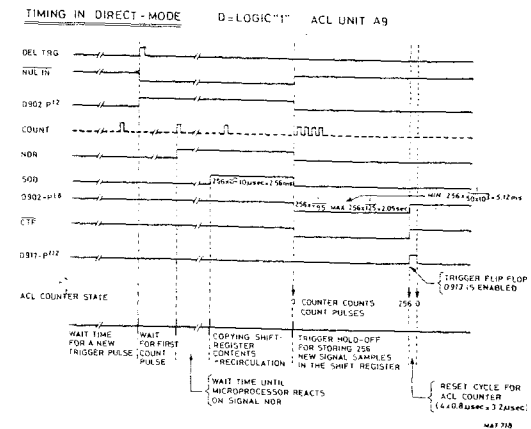

Fig. 6.2.30

#### 6.2.9.4. Timing in Roll mode

If ROLL-mode is selected and the RUN/STOP pushbutton is pressed once, the ROLL-mode action is started by TBS pulses generated on time-base unit A12 after a start signal from the microprocessor. HOCON DRS pulses are derived from the TBS pulses on trigger unit A22. Each HOCON DRS pulse applied to the ACL unit A9 starts an analog-to-digital conversion of a new input signal sample. The ACL unit is set to ROLL-mode by the R control signal. In the ROLL-mode the D-input of the NDR flip-flop D902 is permanently at logic 1 via NAND-gate D903 (1,2,3). Each time a new signal sample is stored in the shift register, a COUNT pulse is generated and an NDR cycle started as described for the P-mode.

During this NDR cycle, the entire shift register contents are copied by the ACCU memory and re-circulated.

The microprocessor and its software calculate the number of NDR cycles and after each 256 the ACCU memory contents are copied in one of the memories STO3, STO2, STO1 under software control. The last 256 samples remain in the ACCU memory. The ROLL-mode is now finished, this being indicated by a flashing RUN lamp on the instrument front panel.

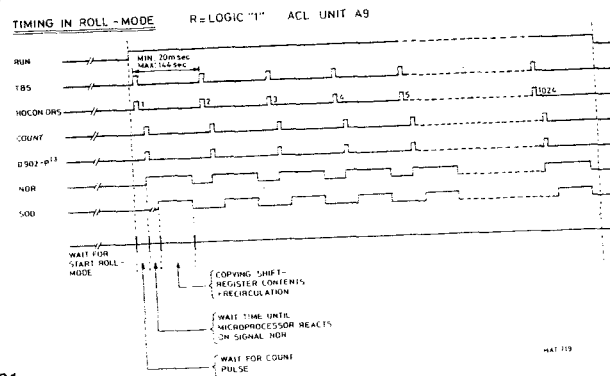

Fig. 6.2.31.

#### 6.2.9.5. Timing in Sampling mode

The control signal S sets the ACL unit in the Sampling mode.

Correct functioning in this mode requires that signals of a repetitive nature are applied to the input channels of the instrument.

Each sampling cycle is started with the staircase counter in the zero position and a pre-determined LEVEL setting.

During one sampling cycle 256 samples of the input signal are stored in the shift register to build a complete signal picture. Each input trigger signal takes one sample of the input signal as now described.

On each trigger signal a fast ramp signal is generated (on unit A22) which is compared with the output of a DAC circuit DACSTAIR, D904. This circuit is coupled to the staircase counter to convert the counter state into the analog signal DACSTAIR.

At the crossover point determined by each comparison of the fast ramp signal and the DACSTAIR signal, an HOCON DRS pulse is generated to start the ADC conversion of the new signal sample.

The time between samples depends on the fast ramp speed which, in turn, is determined by the time-base frequency setting.

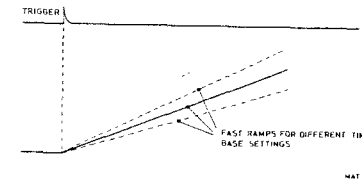

Fig. 6.2.32.

After each conversion, a COUNT pulse is counted by the staircase counter, which causes the DACSTAIR output signal to increase by one step (40 mV).

In this way, the time between the trigger pulses and the generation of the HOCON DRS signal increases so that each new sample is taken one step later.

The shift register is completely filled after 256 samples and its contents can be copied by the ACCU memory. This is initiated by state 256 of the staircase counter. A logic 1 on pin 12 of the counter D917 causes it to reset to zero as already described in the P-mode. The logic 1 level on output 8 of reset flip-flop D902 is fed to the clock input of the NDR flip-flop via multiplexer D901. This starts an NDR cycle and the shift register contents can be copied in the ACCU memory. After this, the staircase counter is again enabled for counting by the positive-going edge of the NDR signal via multiplexer D916 and a new sampling cycle is started.

6.2.9.6. Flip-flop FASA

The flip-flop FASA stores the information indicating whether the last sample stored in the shift register was from channel A or channel B.

FASA = 1 : channel A was last sample  
FASA = 0 : channel B was last sample

In the P-mode, the flip-flop FASA is set to the level of its D-input signal PDRIVE by the leading edge of every INS pulse on its clock input while the PR signal is logic 1 (CHOP is permanently at logic 1 in the P-mode).

In the DRS modes, flip-flop FASA is switched to the level of its D-input signal CHOP by the leading edge of every INS pulse on its clock input (signals PR and PDRIVE are permanently at logic 1 in the DRS modes).

The state of flip-flop FASA cannot be changed while NDR is logic 1, i.e. during the copying of the shift register contents into the ACCU memory. During this cycle the flip-flop state is read by the software.

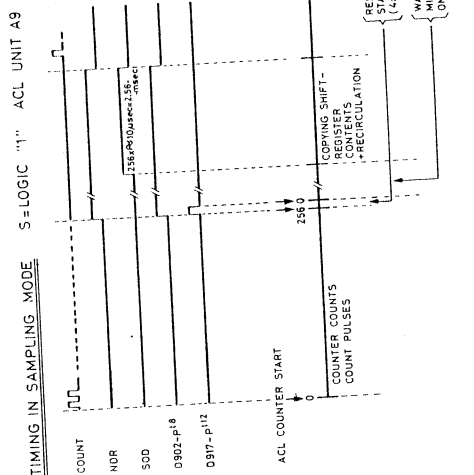

Fig. 6.2.33.

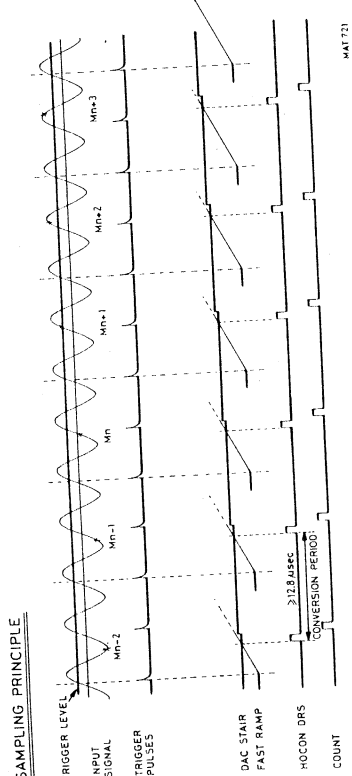

Fig. 6.2.34.

DIGITAL SAMPLING SYSTEM

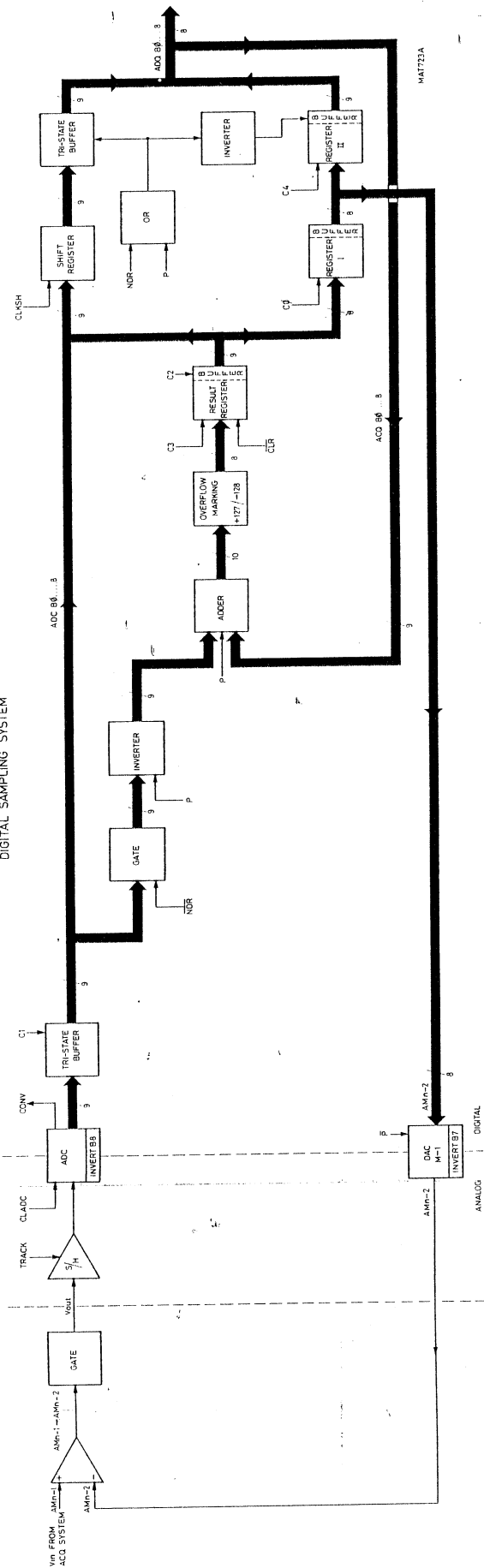

Fig. 6.2.35.

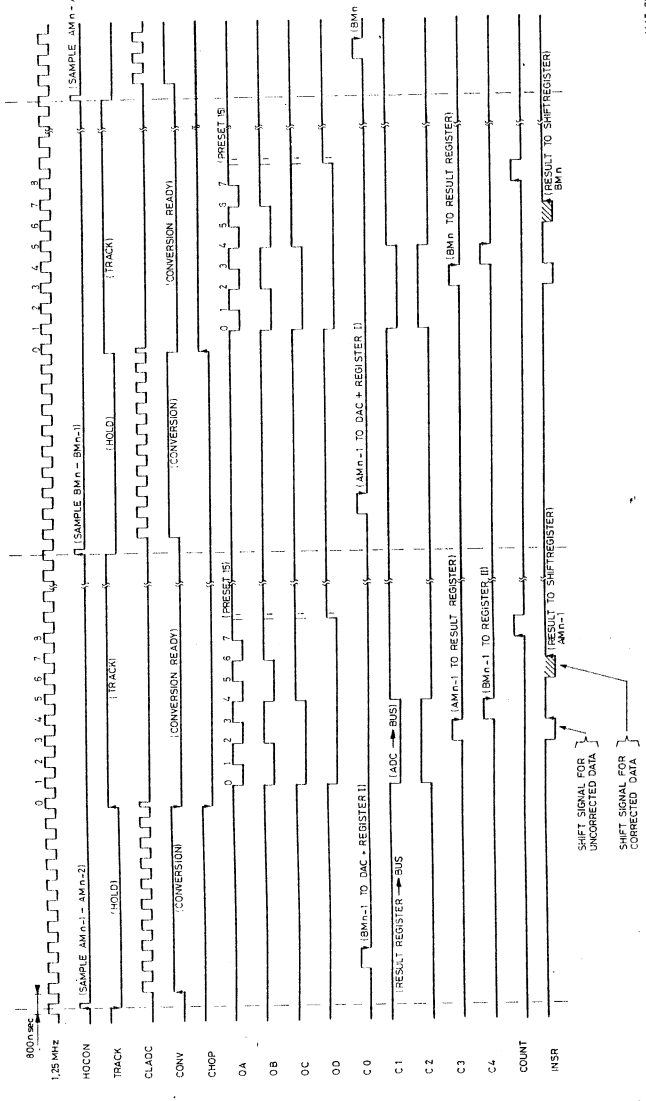

Fig. 6.2.36.





2393	C304	10k	60	7.2
2394	C305	10k	60	7.2
2395	C306	10k	60	7.2
2396	C307	10k	60	7.2
2397	C308	10k	60	7.2
2398	C309	10k	60	7.2
2399	C310	10k	60	7.2
2400	C311	10k	60	7.2

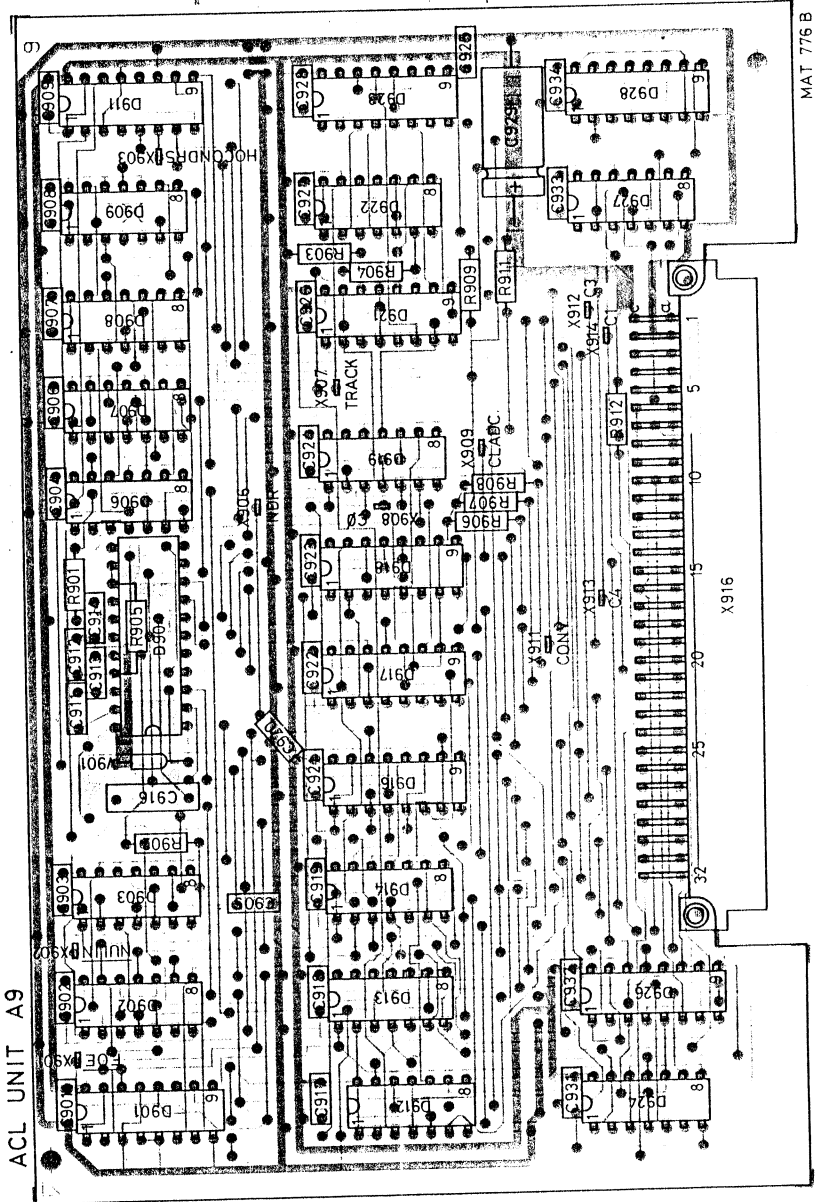
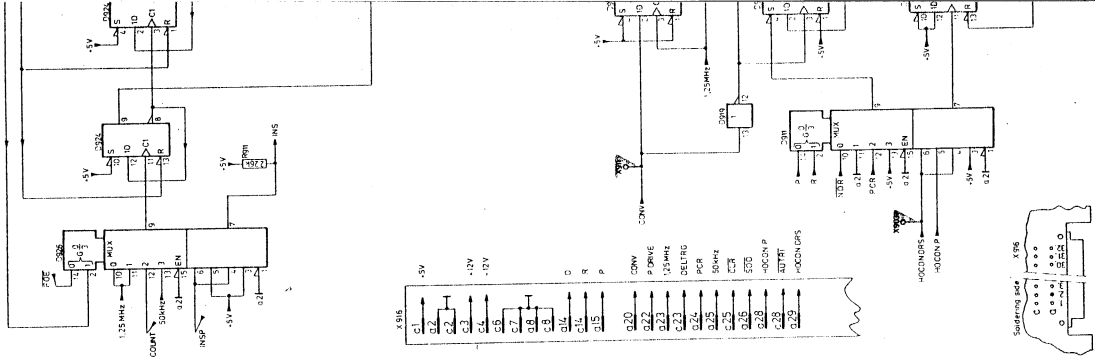
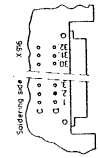
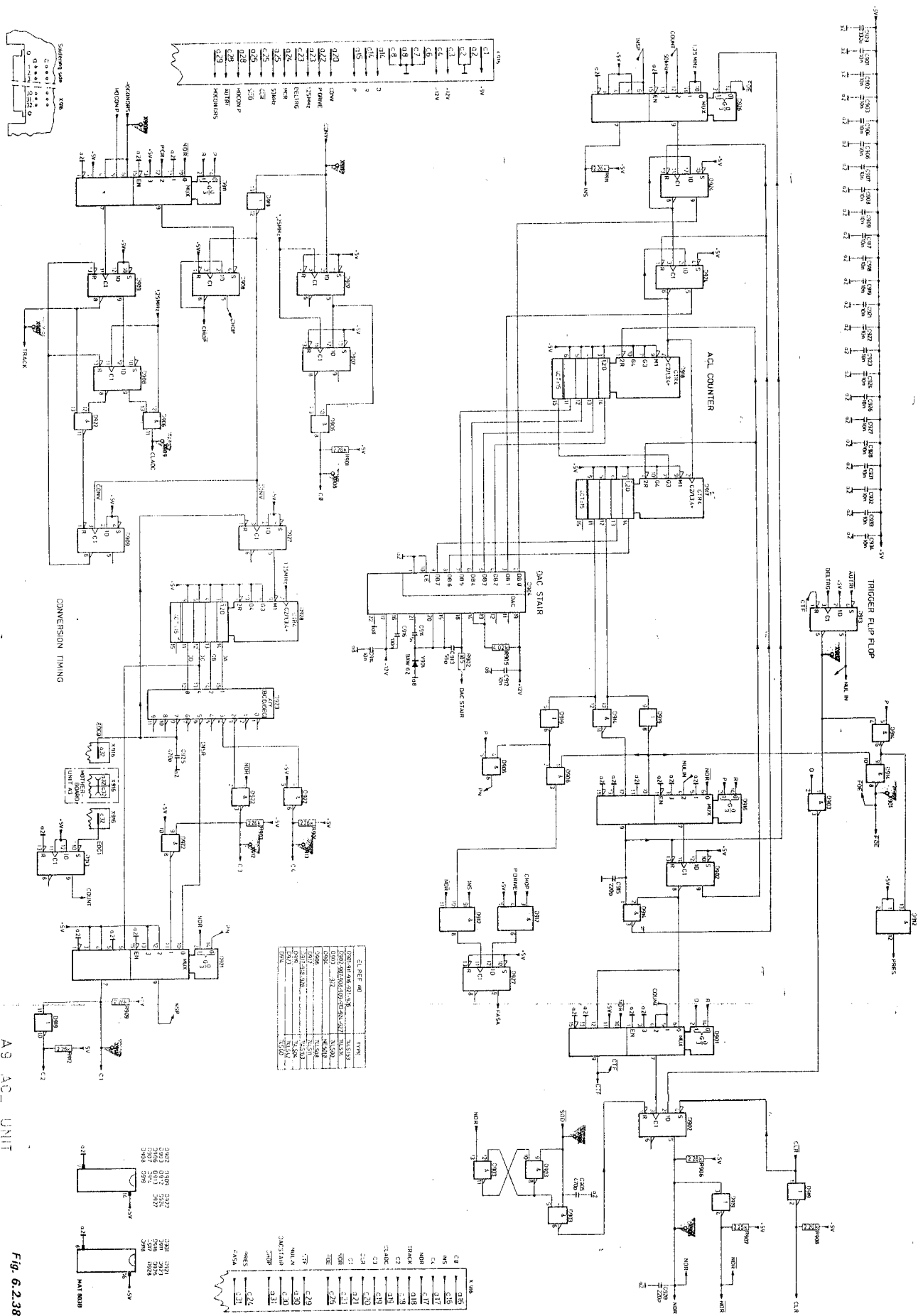

Fig. 6.2.37.





AS A.C. UNIT

Fig. 6.2.38.

6.2.10. CCD logic unit A10

6.2.10.1. General

The CCD logic unit together with the driver unit A34 control the correct functioning of the P<sup>2</sup>CCD circuit on unit 11. The control circuits can be considered under the following headings:

- circuits for various supply voltages
- P<sup>2</sup>CCD external output circuits
- control signals generator
- clock-pulse generator (on unit A34 page 6-232)

6.2.10.2. Circuits for various supply voltages

- +11,4V** From the +12V supply a stabilised +11,4V is derived by the circuit consisting of D3223 (1,2,3) and transistors V3216 and V3211. This +11,4V supply output can be adjusted by potentiometer R3273 at the input of D3223.
- 11,4V** A -11,4V stabilised supply voltage is derived from the -12V supply by the circuit consisting of D3223 (5,6,7) and transistors V3217 and V3212. The level of the -11,4V supply is controlled by the stabilised +11,4V on resistor R3299.
- +5B** A +5V stabilised supply voltage is derived from the +11,4V at input 1 of 03224
- BIAS**

Resumed:

Time base position	Potentiometer	TB	TA
0,2 ms/div .. 1 μs/div	R3206	0	0
0,5 μs/div	R3221	0	1
0,2 μs/div	R3207	1	0

The output of the multiplexer is routed via amplifier 03203 and relevant components to the P<sup>2</sup>CCD circuit.

6.2.10.3. P<sup>2</sup>CCD external output circuits

Output signals OUT PA and OUT PB (from the two sections of the P<sup>2</sup>CCD on unit 11) are applied to two output circuits comprising two multiplexers 03221, D3222 and two integrators consisting of operational amplifiers D3213, D3219 and capacitors C3210, C3222.

In order to obtain a possibility to adjust the zero level for the different time base positions, a corrected zero signal is applied to the upper sections of the two multiplexers D3221 and 03222. These zero signals are derived from the circuit built up around the lower section of multiplexer 03202. This circuit is organised analog to the bias circuitry.

Resumed:

Time base position	Potentiometer	TB	TA
0,2ms/div .. μs/div	93208		
0,5 μs/div	R3222		
0,2 μs/div	R3209		

Both output circuits serve to eliminate output source-follower drift, noise signals and clock-pulse or reset crosstalk signals that would influence the P<sup>2</sup>CCD output signals.

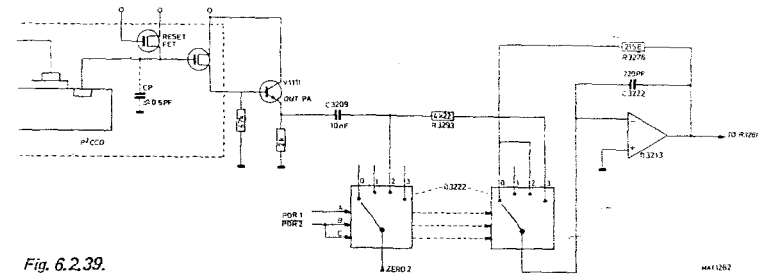

Fig. 6.2.39.

As a result, clean output signals are produced, which are applied via multiplexer D3206 and amplifier stage D3204 to the conversion unit A8 as the V OUT signal.

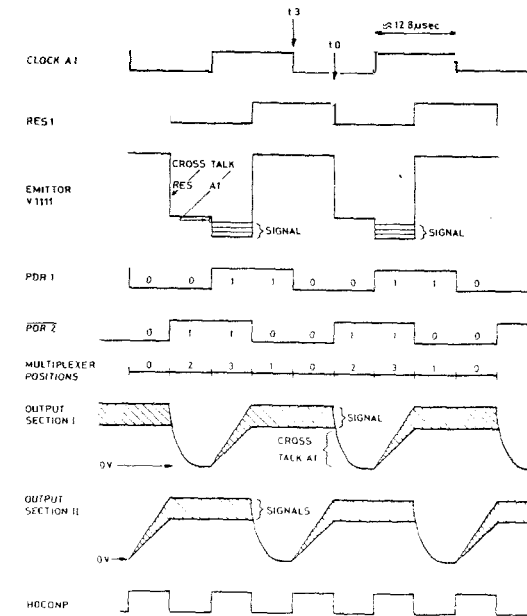

Fig. 6.2.40.

Before time  $t_0$ , signal RES1 is at logic 1, which causes the P<sup>2</sup>CCD reset FET to conduct. The parasitic capacitor  $C_p$  of the source-follower gate is then charged to the level of the DRAIN RS1 voltage.

At the moment  $t_0$ , signal RES1 switches to logic 0 and the reset FET goes non-conducting. Due to the crosstalk of signal RES1 present on the source-follower gate, a voltage jump appears on the emitter of transistor V1111.

During the time between  $t_0$  and  $t_1$ , the analog multiplexer D3222 is set to position 2 by its control signals PDR1 and PDR2. Capacitor C3209 is then charged to the level on the emitter of V1111. At the same time, integrator capacitor C3222 will be discharged to 0V via position 2 of the multiplexer.

At  $t_1$  (the positive-going edge of the clock-signal A1), a signal sample is fed to the source-follower gate, which results in a change of the voltage across  $C_p$ . This voltage across  $C_p$  is also influenced by crosstalk from the clock-signal A1. The emitter of transistor V1111 follows the voltage changes across  $C_p$ .

During the time between  $t_1$  and  $t_2$ , the multiplexer D3222 is set to position 3. The difference between the emitter voltage of V1111 and the voltage across C3209 is now applied across R3293 and is integrated by the circuit D3213 and C3222. As can be seen from the timing diagram, the crosstalk of RES1 is now completely suppressed.

During the time between  $t_2$  and  $t_3$ , the analog multiplexer switches to either position 1 or 0, but the multiplexer is not then enabled (signal PDR2 on the enable input G4). The output voltage therefore remains available on pin 6 of D3213.

A similar external output circuit is available for signal OUT PB, resulting in integrated voltages on pin 6 of D3219. Because of the differences in control signals PDR1 and PDR2, the signals are 180° phase-shifted.

The signals that are read into the P<sup>2</sup>CCD for temporary storage need to be converted into digital information for permanent storage in a digital memory.

For this purpose, the output signals on pins 6 of D3213 and D3219 are applied to a multiplexer, D3206.

This multiplexer switches both P<sup>2</sup>CCD output signals to one single serial output signal V OUT, when P-mode is selected (signal P at logic 1).

Signal PDR2 is responsible for switching over from output section I to output section II. For the DRS modes the multiplexer D1008 switches the signal DRS to its output V OUT.

Amplifier stage D3212 is switched as an inverter.

This is necessary to correct for the different phase of the signal in the P<sup>2</sup>CCD.

Preset potentiometers provide gain adjustment for the two P<sup>2</sup>CCD sections at different time base settings.

Signal V OUT is applied to conversion unit A8.

6.2.10.4. Control signals generator

In the P-mode, the signals P, PRES,  $\overline{FOE}$  and 78kHz are converted from TTL to ECL by D3218.

As long as signal PRES = logic 1, these signals control the two D-type flip-flop D3217, which generate the signals WREP and RDEP.

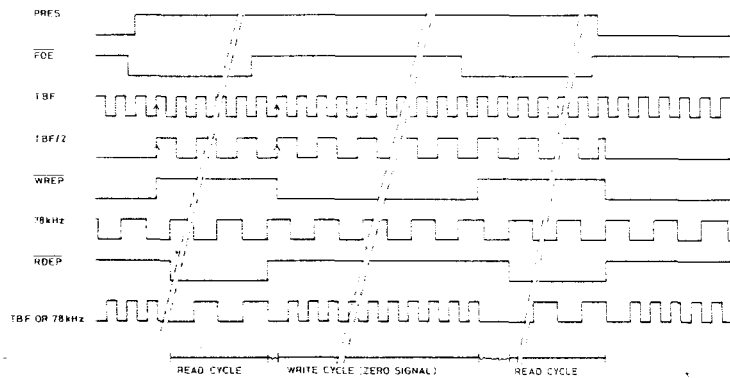

Fig. 6.2.41.

As shown in the timing diagram, during the time that signal  $\overline{WREP}$  = logic 0, new signal samples will be shifted into the P<sup>2</sup>CCD with a clock-frequency signal derived from signal TBF. (WREP: WRITE ENABLE P-MODEI).

Signals WREP and  $\overline{WREP}$  are only switched synchronously with even TBF pulses (TBF/2) in order to achieve precise zero-correction (see ACL unit A9). This is realised by dividing the TBF pulses using the lower flip-flop of D3216, resulting in signal TBF/2, which is used as a clock-signal for flip-flop WREP.

During the time that signal  $\overline{RDEP}$  = logic 0, the P<sup>2</sup>CCD contents are shifted out with a clock-frequency derived from signal 78 kHz.

Signals RDEP and  $\overline{RDEP}$  are only switched synchronously with the 78 kHz signal. (RDEP: READ ENABLE P-MODE).

The signal on pin 10 of NOR-gate D3208 is built up by TBF or 78kHz. This signal, which is applied to pin 6 of D3209, is also inverted by D3208 and applied to pin 11 of D3209. These flip-flops and the associated circuits that follow (D3211, D3214) generate the signals listed below in accordance with the timing diagram.

- RES1: Reset signal for P<sup>2</sup>CCD output section I
- RES2: Reset signal for P<sup>2</sup>CCD output section II
- PDRIVE: P<sup>2</sup>CCD phase signal
- PDR1 & PDR2: Control signals for multiplexers D1018, D1019 and D1008
- CLKDR: Drive signal for clock-pulse generator.

Integrated circuits D3214 are ECL/TTL converters of which one output is connected to an internal reference voltage of -1.2V.

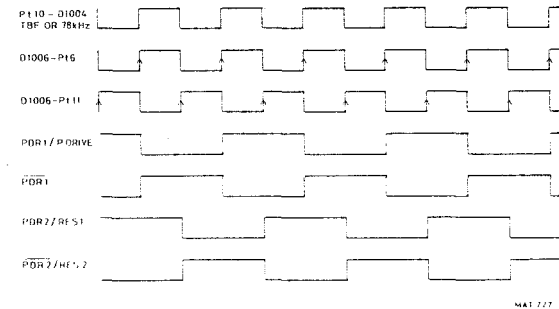

Fig. 6.2.42.

The whole system is inactive while signal  $\overline{PECL}$  from the time-base unit is at logic 1. Signal PDRIVE will then be permanently at logic 1.

Furthermore, the generation of signals PDR1, PDR2, PDR2, PDRIVE, RES1 and RES2 is inhibited while signal WREP is at logic 1. This signal is at logic 1 during the reading of new signal samples into the P<sup>2</sup>CCD. Signals RES1 and RES2 are then positive to open the reset FET during reading in.

*Signal HOCONP (Hold and Convert in P-mode)*

HOCONP pulses are only generated during the reading of the P<sup>2</sup>CCD contents. These pulses are derived from the 78kHz pulses via NOR-gate 03208 while signal RDEP = logic 0 (RDEP: READ ENABLE IN P-mode). Immediately the first P<sup>2</sup>CCD signal sample is available for conversion to digital, the leading edge of the first HOCONP pulse has already passed. Therefore, this analog-to-digital conversion has to be started on the second HOCONP pulse.

For this reason, the first HOCONP pulse is suppressed by the upper flip-flop of D3216 as shown in the following diagram.

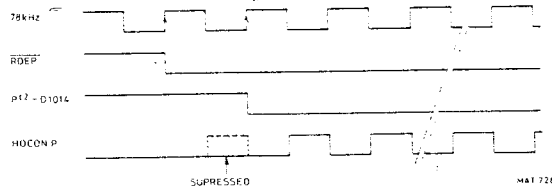

Fig. 6.2.43.

INCOMING SIGNAL	OUTGOING SIGNAL	GENERATED ON UNIT	USED ON UNIT	DESCRIPTION
	BIAS	A10 A11	A11	Bias voltage
FOE		A9		Frequency output enable
OUTPA		A11		P <sup>2</sup> CCD output signal section I
OUTPB		A11		P <sup>2</sup> CCD output signal section II
P		A12		P-mode signal
PECL		A12		P-mode signal for ECL circuits
PRES		A9		Enable signal in P-mode
	RES1	A10	A11	Reset signal 1
	RES2	A10	A11	Reset signal 2
78kHz		A12		78kHz pulse
	+11.4V	A10	A11/A34	
	+40V	A10	A11	
-5.2V		A15		
+6V		A15		
-6V		A15		
+12V		A15		
-12V		A15		
+40V		A15		
DRS		A21		Signal from T & H gate
TBF		A12		Time-base fast
	VDUT	A10	A8	CCD logic unit analog output signal
	HOCONP	A10	A9	Hold and convert in P-mode
	-5.2V	A10	A11/A34	
	-11.4V	A10	A11/A34	
	PDRIVE	A10	A9	Phase signal in P-mode
	ZERO	A10		
	P <sup>2</sup> CCD clock	A10	A34	Clock for P <sup>2</sup> CCD
	P <sup>2</sup> CCD CLOCK	A10	A34	Inverted clock for P <sup>2</sup> CCD
TA		A12		Control signal for P <sup>2</sup> CCD adjustment
TB		A12		Control signal for P <sup>2</sup> CCD adjustment

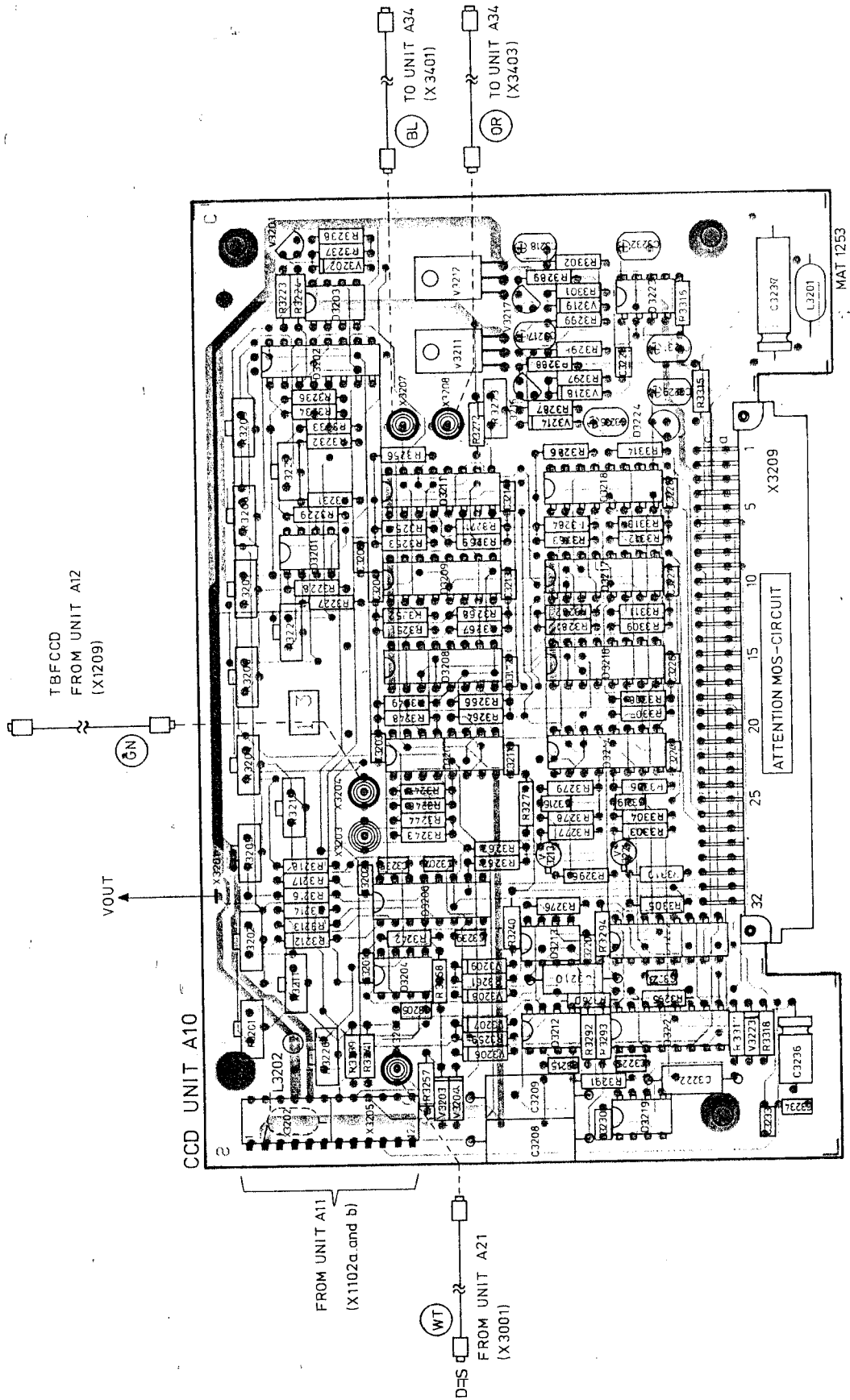
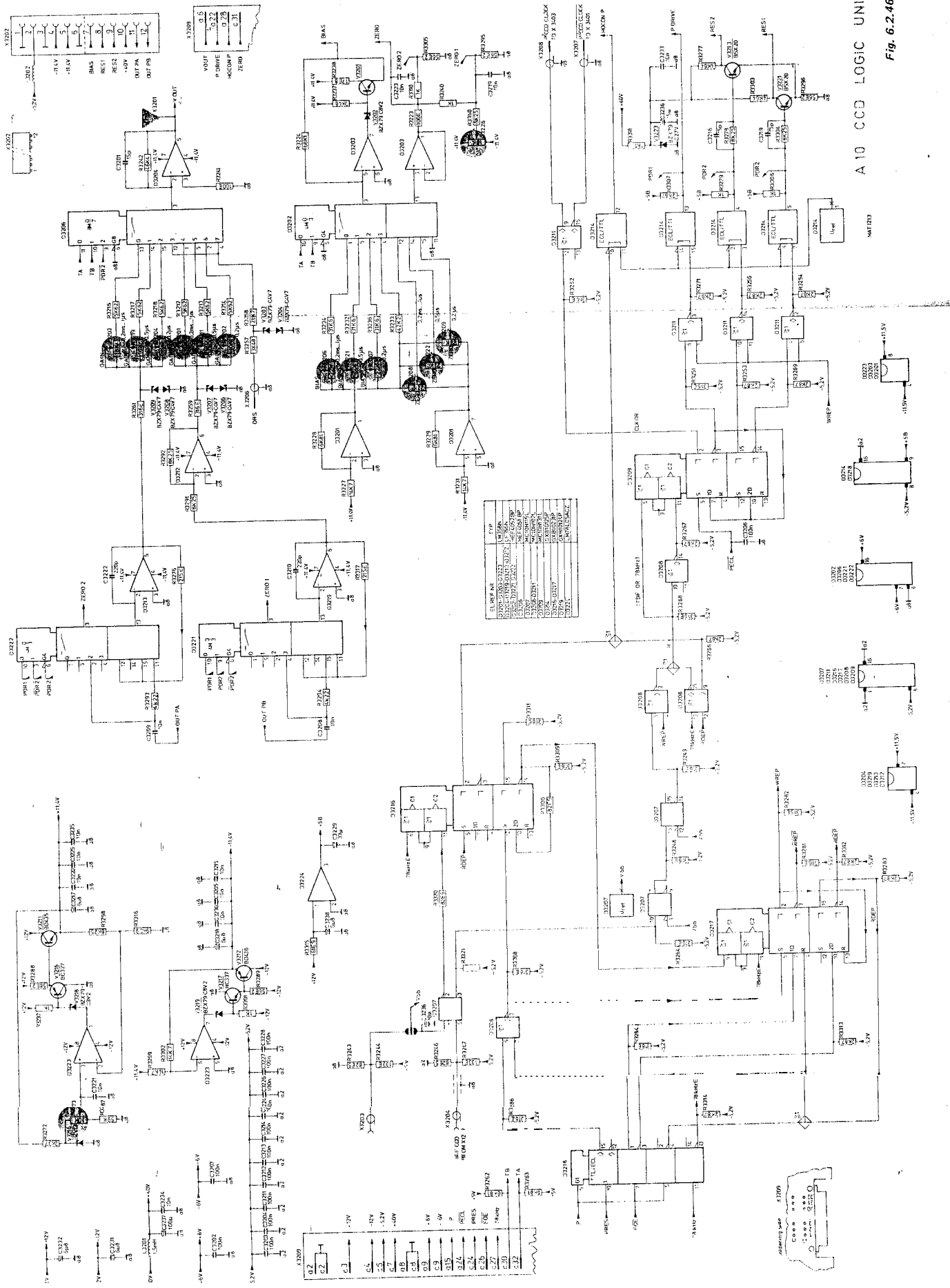

Fig. 6.2.45.



A10 CCD LOGIC UNIT

Fig. 6.2.46.



6.2.11. P<sup>2</sup>CCD unit A11

## 6.2.11.1. General

The P<sup>2</sup>CCD circuit (Profiled Peristaltic Charged Coupled Device) is used in this digital storage oscilloscope as an analog shift register. Using this circuit, different time conversions can be realised in the TIME/DIV switch positions 0,2 $\mu$ s/DIV up to 0,2ms/DIV to digitise fast input signals with a relatively slow (12,8 $\mu$ s approx.) analog-to-digital converter.

The P<sup>2</sup>CCD circuit D1101 located on unit 4 11 consists of two CCD sections in parallel. These two sections are required in order to take samples of the input signal on the 0° phase and on the 180° phase of the clock signal.

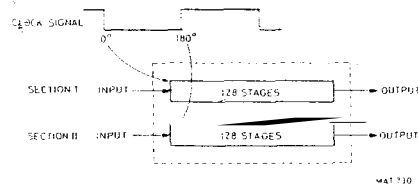

Fig. 6.2.47.

Each section consists of 128 stages, i.e. the complete circuit D1101 contains 256 stages in which a total of 256 samples can be stored.

In addition, each section consists of a system for the transport of charges, an input circuit that accepts the charges from the vertical channel switch signals P AMP OUT 1 and P AMP OUT 2, and an output section which measures the sizes of the charges and produces corresponding output signals.

Samples can be taken from the analog input signal at a high sample rate, which varies between 125 kHz and 125MHz depending on the TIME/DIV switch setting. These samples are shifted into the P<sup>2</sup>CCD.

After the reading in of information in all the 256 stages, the reading out cycle is started. The entire operation is carried out under the control of the acquisition control logic and the CCD logic unit.

The P<sup>2</sup>CCD circuit contents are read out with a lower frequency of 78 kHz approx.

This frequency remains the same for the different TIME/DIV switch settings and is low enough to guarantee perfect ADC conversion by the ADC on unit A8.

The frequency must not be too low otherwise loss of information could occur in the P<sup>2</sup>CCD circuit.

## 6.2.11.2. Input section

Each of the two sections of the P<sup>2</sup>CCD circuit has its own Input section. One of these input sections is now described. This particular section has the following Inputs:

- IN1 (pin 22)                      this input is connected to the clock signal P2 in such a way that the d.c. voltage level on IN1 is always about 13 V more positive than the P2 signal level.
- P11IN (pin 21)                 this is a threshold voltage set to +6 V approx.
- A11IN (pin 17)                 this is connected to the analog input signal P AMP OUT 1 with a maximum amplitude of 1 V peak-peak on a d.c. bias level of about +7,5 V.

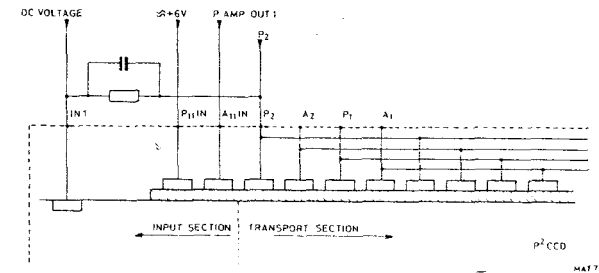

Fig. 6.2.48.

For correct sampling of the input signal, it is most important that the low level (+2 V) of the clock signal P2 remains constant. For higher frequencies, the amplitude of the clock signal P2 decreases due to the Capacitive loading caused by the P<sup>2</sup>CCD circuit.

A control loop is used to ensure that the low level of P2 remains constant.

The clock signals P2 and P1 are measured by the circuit V1101, V1117, which results in a feedback signal CLF for the four-phase clock-pulse generator on unit A34.

(CLF = CLOCK AMPLITUDE FEEDBACK).

6.2.1.7.3. Transport section

The four clock signals P2, A2, P1 and A1 are used to shift information in and out of the P<sup>2</sup>CCD. These signals, generated on CCD logic unit A34, are derived from the 125kHz ...125MHz input frequency (TBF) from the time-base circuit (A12) when reading in, and from a 78 kHz input frequency when reading out.

Each stage inside the P<sup>2</sup>CCD consists of four gates that are isolated from each other, and are controlled by the four clock signals as shown in the following diagram.

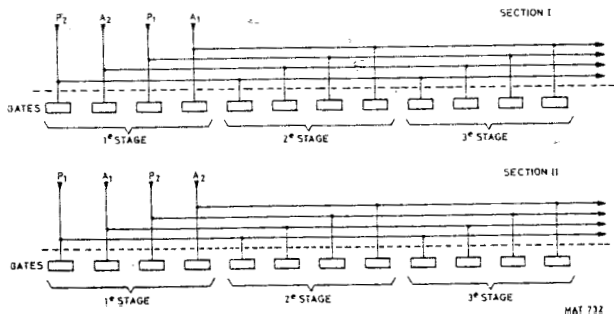

Fig. 6.2.49.

The charges are transported in the following way:

Assume for instance that a negative charge is brought under a positive gate. If the next gate is made positive and the previous gate is made negative, the charge will be repelled in the direction of the position gate.

Displacement of charges is achieved in practice by changing the levels on the gates by the four periodically changing clock-pulses. For a description of the clock-pulse generator, refer to unit A10.

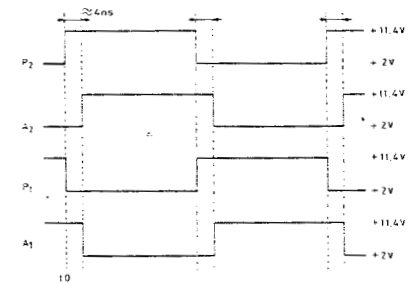

Fig. 6.2.50. Timing clock signals

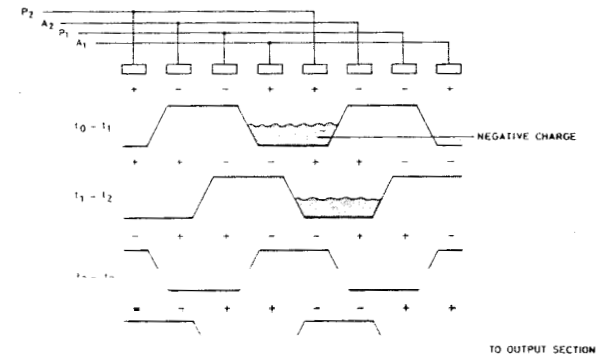

Fig. 6.2.51. Displacement of a negative charge as a function of the clock voltages

6.2.11.4. Output section

Each of the two P<sup>2</sup>CCD sections has its own output stage, as now described.

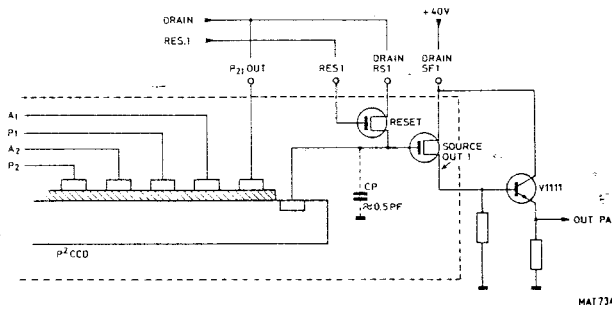

Fig. 6.2.52.

On every positive-going edge of the clock signal A1 a charge will load the parasitic capacitor  $C_p$  of the source-follower gate (previously discharged to the DRAIN RS1 voltage level by the reset FET1).

The level across  $C_p$  will leave the output section via the appropriate source-follower. Both FET transistors are also part of the P<sup>2</sup>CCD circuit.

The output signal is approx. 100 mV for an input signal ( $V_{in}$ ) of 1 Vp-p.

This source-follower output signal is applied to an emitter-follower V1111 which in turn feeds it as signal OUTPA to an output amplifier on unit A10.

6.2.11.5. P<sup>2</sup>CCD circuit in dualchannel mode

In the dualchannel mode, channel A signal is shifted to section I and channel B to section II. The clock signals for the two sections are in anti-phase, which results in a situation where the P<sup>2</sup>CCD itself acts as a chopper.

The chopper frequency depends on the TIME/DIV switch setting.

This dual-mode of working results in 128 samples per channel being stored, instead of 256.

INCOMING SIGNAL	OUTGOING SIGNAL	GENERATED ON UNIT	USED ON UNIT	DESCRIPTION
BIAS	CLF OUTPA OUTPB	A10		Bias voltage
		A11	A10	Clock-pulse amplitude feedback
RES1		A11	A10	P <sup>2</sup> CCD output signal section I
		A10		P <sup>2</sup> CCD output signal section II
RES2		A10		Reset signal 1
		A10		Reset signal 2
+11,4V		A10		
		A10		
+40V		A10		
		A10		
PAMPOUT1		A21		Output signal of amplifier
		A21		Output signal of amplifier
-5,2V		A10		
		A10		
-11,4V		A10		
		A10		
P1	A1 A2		A34	To 50Ω terminator
			A34	To 50Ω terminator
P2		A34		Clock pulse
		A34		Clock pulse

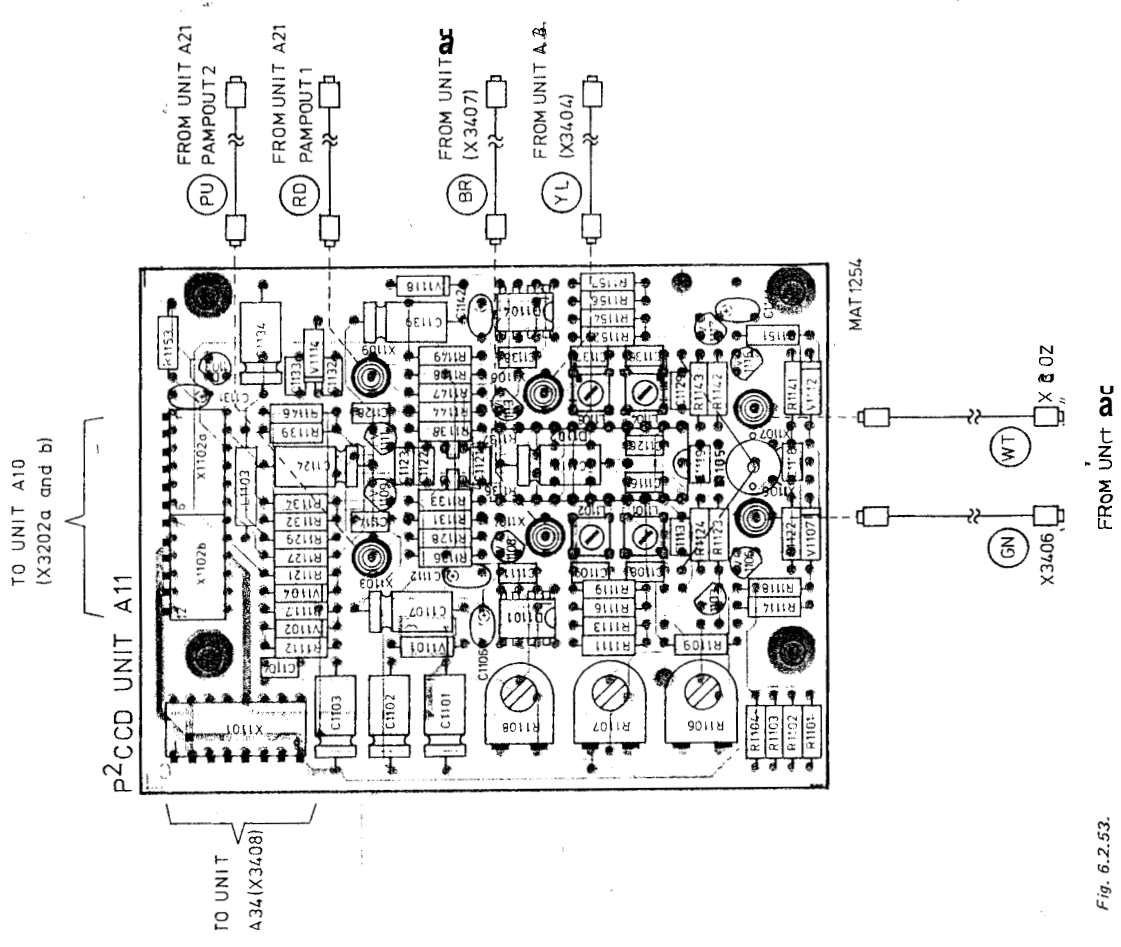
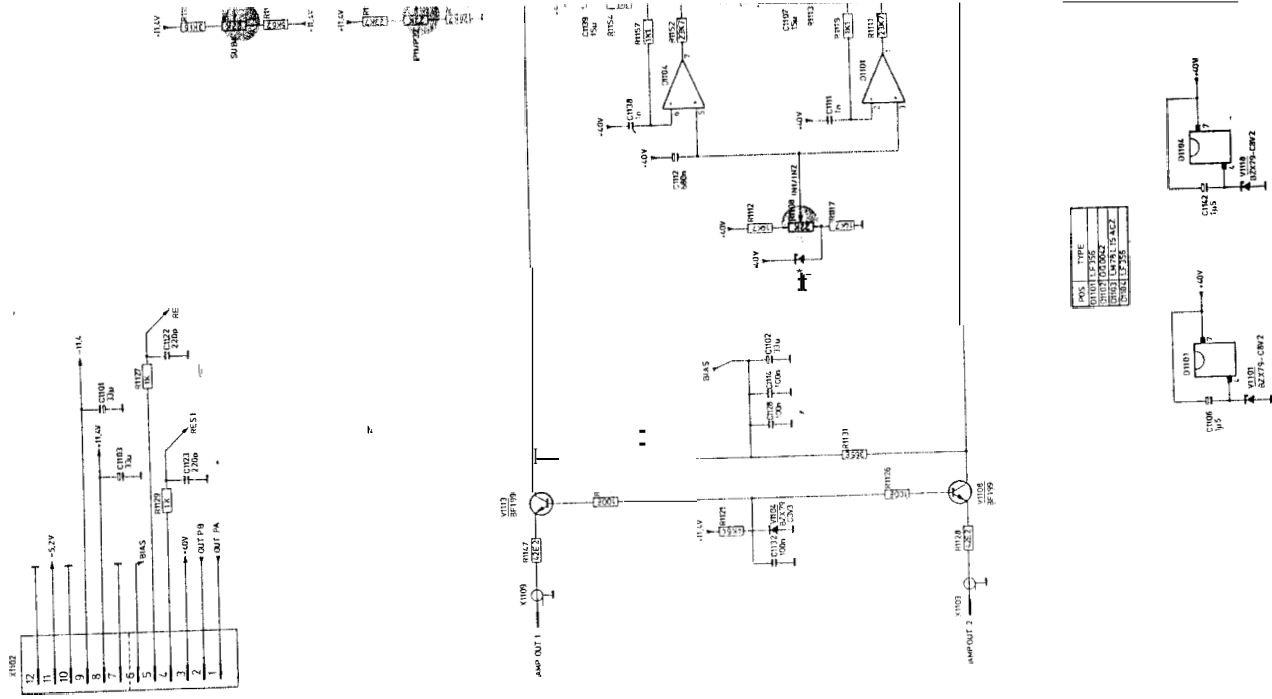

Fig. 6.2.53.



### 6.2.12. Time-base unit A12

The time-base unit generates a number of control signals of different frequencies derived from the microprocessor clock-pulse output signal of 2.5 MHz.

#### 6.2.12.1. Encoding TIME/DIV settings

Depending on the setting of the TIME/DIV switch, one of these frequencies is selected and applied to other units as signals TBF (time-base fast, used in P<sup>2</sup>CCD mode) or TBS (time-base slow, used for other modes).

The relation between the TIME/DIV switch settings and the signals TBF and TBS is such that there are always 25 pulses (TBF or TBS) generated per horizontal division.

The settings of the TIME/DIV switch are read by the microprocessor system (unit A2).

The microprocessor loads the 8-bit latch D1221 with a byte of data according to the TIME/DIV settings listed in the following table.

Latch D1221 is selected when the microprocessor generates address 8060H.

When the microprocessor places this address on the address bus, signal  $\overline{IO6}$  goes to logic 0.

This  $\overline{IO6}$  signal combined with the  $\overline{WR}$  signal enables data latch D1221 to latch the data present on the data bus

The output signals of latch D1221 have the following functions:

D0 ... D4\* used to control the various multiplexers on time-base units A12.

D5 enables or disables the output signal TBS

D6\* and D7\* these signals together, control decoder D1216, which results in the four mode signals:

- P - P<sup>2</sup>CCD mode
- D - Direct mode
- R - Roll mode
- S - Sampling mode

TIME/DIV	FREQUENCY	MODE	D7	D6	D5	D4	D3	D2	D1	D0	TB	TA
5 ns/div		S	1	1	0	0	0	1	1	0	1	1
10 ns/div		S	1	1	0	0	0	0	0	1	1	1
20 ns/div		S	1	1	0	0	0	1	0	0	1	1
50 ns/div		S	1	1	0	0	0	1	0	1	1	1
1.1 μs/div		S	1	1	0	0	0	0	0	0	1	1
TEF												
0.2 ps/div	125 MHz	P	0	0	0	0	0	1	1	1	1	0
15 ps/div	50 MHz	P	0	0	0	0	1	1	0	1	0	1
1 ps/div	25 MHz	P	0	0	0	0	1	1	1	0	0	1
2 ps/div	12.5 MHz	P	0	0	0	0	1	0	1	0	0	1
5 ps/div	5 MHz	P	0	0	0	0	1	0	1	1	0	1
10 μs/div	25 MHz	P	0	0	0	1	0	0	0	1	0	1
20 ps/div	1.25 MHz	P	0	0	0	1	0	0	1	0	0	0
50 ps/div	0.5 MHz	P	0	0	0	1	0	0	1	1	0	0
0.1 ms/div	0.25 MHz	P	0	0	0	1	1	0	0	1	0	1
0.2 ms/div	125 kHz	P	0	0	0	1	1	0	1	0	0	1
TBS												
1.5ms/div	50 kHz	D	1	0	1	0	0	0	0	0	1	1
1 ms/div	25 kHz	D	1	0	1	0	0	0	0	1	1	1
2 ms/div	17.5 kHz	D	1	0	1	0	0	0	1	0	1	1
5 ms/div	5 kHz	D	1	0	1	0	0	1	0	0	1	1
10ms/div	25 kHz	D	1	0	1	0	0	1	0	1	1	1
20ms/div	125 kHz	D	1	0	1	0	0	1	1	0	1	1
50ms/div	500 Hz	D	1	0	1	0	1	0	0	0	1	1
1.1 s/div	250 Hz	D	1	0	1	0	1	0	0	1	1	1
1.2 s/div	125 Hz	D	1	0	1	0	1	0	1	0	1	1
TBS												
0.5 s/div	50 Hz	R	0	1	0/1	0	1	1	0	0	1	1
1 s/div	25 Hz	R	0	1	0/1	0	1	1	0	1	1	1
2 s/div	12.5 Hz	R	0	1	0/1	0	1	1	1	0	1	1
5 s/div	5 Hz	R	0	1	0/1	1	0	0	0	0	1	1
10 s/div	2.5 Hz	R	0	1	0/1	1	0	0	0	1	1	1
20 s/div	1.25 Hz	R	0	1	0/1	1	0	0	1	0	1	1
30 s/div	5/6 Hz	R	0	1	0/1	1	0	1	0	0	1	1
60 s/div	5/12 Hz	R	0	1	0/1	1	0	1	0	1	1	1
120 s/div	5/24 Hz	R	0	1	0/1	1	0	1	1	0	1	1
360 s/div	5/72 Hz	R	0	1	0/1	1	1	0	0	0	1	1
900 s/div	5/180 Hz	R	0	1	0/1	1	1	1	0	1	1	1
800 s/div	5/360 Hz	R	0	1	0/1	1	1	1	1	0	1	1
600 s/div	5/720 Hz	R	0	1	0/1	1	1	1	1	1	1	1
												1

D5 = 1 → RUN  
D5 = 0 → STOP

6.2.12.2. Generation of signals 1.25MHz, 0.5MHz, 250 kHz, 156kHz, 78kHz

The 25 MHz clock-pulse signal from the microprocessor is divided by factors of 2, 5 and 10 in divider D1206, resulting in signals 1.25 MHz (pin 3), 0.5 MHz (pin 4) and 250 kHz (pin 6) respectively.

Two other signals are derived from the 1.25 MHz signal by D1207, which divides by factors of 8 and 16. These divisions produce a signal of 156 kHz for use in the 2-amplifier and a signal of 78 kHz for reading out the contents of the P<sup>2</sup>CCD unit.

6.2.12.3. Generation of TBS signals for the D and R modes

The 0.5 MHz signal on pin 4 of D1206 is applied to pin 10 of D1206, the first of a chain of dividers consisting of D1206, D1204, D1203, D1202 and D1201.

The first three of these divide by a factor of ten, thus producing the frequencies 50 kHz, 5 kHz, 500 Hz, 50 Hz and 5 Hz.

The 25 kHz output from D1204 pin 11 is applied via inverter D1218 (8, 9, 10) to the final amplifier unit A20 for generating the CAL voltage.

Pin 2 of D1203, normally at 500 Hz, can be switched to 25 MHz by switch S1201 for test purposes in the ROLL-Mode.

Circuit D1202 divides the 5 Hz input signal by a factor of 6 to give an output signal with a frequency of 5/6 Hz. In turn, D1201 divides this 5/6 Hz input signal by a factor of 12 if D2\* is logic 0, and by a factor of 15 if D2\* is logic 1, thus producing frequencies of 5/72 Hz or 5/90 Hz.

All these frequencies are routed to multiplexer D1214, the outputs of which are controlled by signals D2\*, D3\* and D4\*.

Only one of the input frequencies appears on output 3 of D1214 and is applied in one of two ways to multiplexer D1219:

- directly to input 6 of D1219, or
- first divided in D1207 by factors of 2, 4 and 8 and then applied to inputs 5, 4 and 3 of D1219.

Multiplexer D1219 is controlled by signals D0\* and D1\*.

The final selected frequency, obtained via NOR-gate D1217 as signal TBS, is applied to the trigger unit.

The output TBS can be disabled by flip-flop D1222, under the control of the D5\* signal. Signal TBS is blocked at the end of the ROLL-mode and in the P-mode. D\* is then logic 0.

#### 6.2.12.4. Generation of T8F signals for the P-mode

Signals of a higher frequency than the microprocessor clock-pulse output signal of 2.5 MHz are generated by means of a voltage-controlled oscillator (VCO) D1213 that has an output frequency of 100 MHz. The output frequency of this oscillator is controlled by a d.c. voltage, VC, on the VCO input, pin 2. To obtain this stable VCO output, the 100 MHz output is divided by a factor of 80 in circuits D1227, D1209 and D1208. The resulting 1.25 MHz signal, VCO/80, is then compared with a reference signal of the same frequency in a phase detector, which is then used to control the VCO frequency.

The phase detector comprises the flip-flops D1211 and the associated integrator circuit. These flip-flops are set and reset in accordance with the timing diagram shown below.

The output signals on pins 1 and 12 are added and applied to pin 2 of D1212 of the integrator. The resulting signal VC, controls the VCO to ensure a constant frequency. The VCO is only switched into circuit by signal VCOEN (VCO Enable) in the 5 TIME/DIV switch position 0, 2  $\mu$ s/div to 5  $\mu$ s/div.

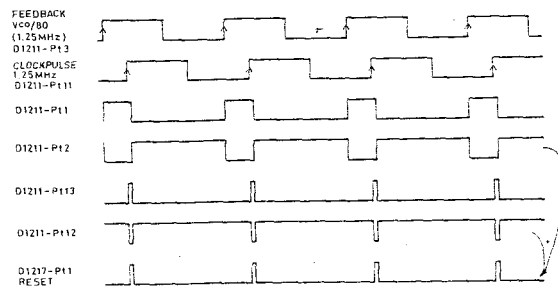

Fig. 6.2.55.

MAT 735A

Divider D1227 derives the 50 MHz and 25 MHz signals from the 100 MHz VCO output signal, these being routed to multiplexer D1224 for selection.

The 25 MHz signal is also applied to a multiplexer D1223 via ECL/TTL converter D1231. This multiplexer selects one of the input signals 25 MHz, 2.5 MHz and 250 kHz under the control of signals D3\* and D4\*.

The 25 MHz output signal from D1223 is divided in D1209 by a factor of 5 and a factor of 2. From there it is divided further in D1208 by a factor of 2, giving a signal VCO/80 of 1.25 MHz on output pin 12 of D1208. This is the 1.25 MHz signal that is fed back to the phase detector for controlling the VCO frequency.

In the position 0, 2  $\mu$ s/div the VCO is adjusted to 125 MHz.

The data lines D3\* and D4\* are both 0 in this position and thus is the multiplexer switching the signal VCO/100 as the feed-back frequency.

Now the frequency of 125 MHz is available at output 4 of D1213 and this signal is routed to inputs 3 and 13 of multiplexer D1224.

The following frequencies are also available:

- output pin 9 of D1223: 25 MHz, 2.5 MHz or 250 kHz
- output pin 8 of D1222: 12.5 MHz, 1.25 MHz or 125 kHz
- output pin 12 of D1209: 5 MHz, 500 kHz (or 50 kHz - not used)

After selection by multiplexer D1219 (only enabled in P-mode), one of these frequencies appear on Output pin 9 of D1219.

The selected signal is applied to multiplexer D1224 via a TTL/ECL converter, D1226

Multiplexer D1224, which is controlled by D0\*, D1\* and D2\*, is employed for the final selection of the frequency of the output signal TBF. This signal is applied to the CCD logic unit A10 via a 50  $\Omega$  cable. In Parallel, a TBF signal is generated, which is connected via a 50  $\Omega$  cable to the trigger unit A13.

INCOMING SIGNAL	OUTGOING SIGNAL	GENERATED ON UNIT	USED ON UNIT	DESCRIPTION
00 - D7 106	D	A12 A4 A4	AS	DIRECT-mode signal Data bits from system data bus Address decoding signal TB select
	R	A12	AS	ROLL-mode signal
	S	A12	A9-A22	SAMPLE-mode signal
	P	A12	A7-8-9-10-21	P <sup>2</sup> CCD-mode signal
	PECL	A12	A10	P-mode signal from ECL circuits
	TBF CCD	A12	A10	Time-base fast for CCD unit
	TBF TRIGGER	A12	A13	Time-base fast for TRIGGER unit
	TBS	A12	A13-A22	Time-base slow signal
	50 kHz	A12	AS	
	78 kHz	A12	A10	
	2.5 kHz	A12	A20	2.5 kHz for CAL voltage
	156 kHz	A12	A15	
	1.25 MHz	A12	AS-13	
WR 2.5 MHz +5 V -5.2 V		A4 A4 A15 A15		Signal WRITE from microprocessor Microprocessor clock-pulse output signal

#### TEST POINTS

X1201	RESET
X1202	LOW
X1203	5 Hz
X1204	156 kHz
X1207	TBF
X1208	VC <sub>x</sub>



TIME-BASE UNIT A12

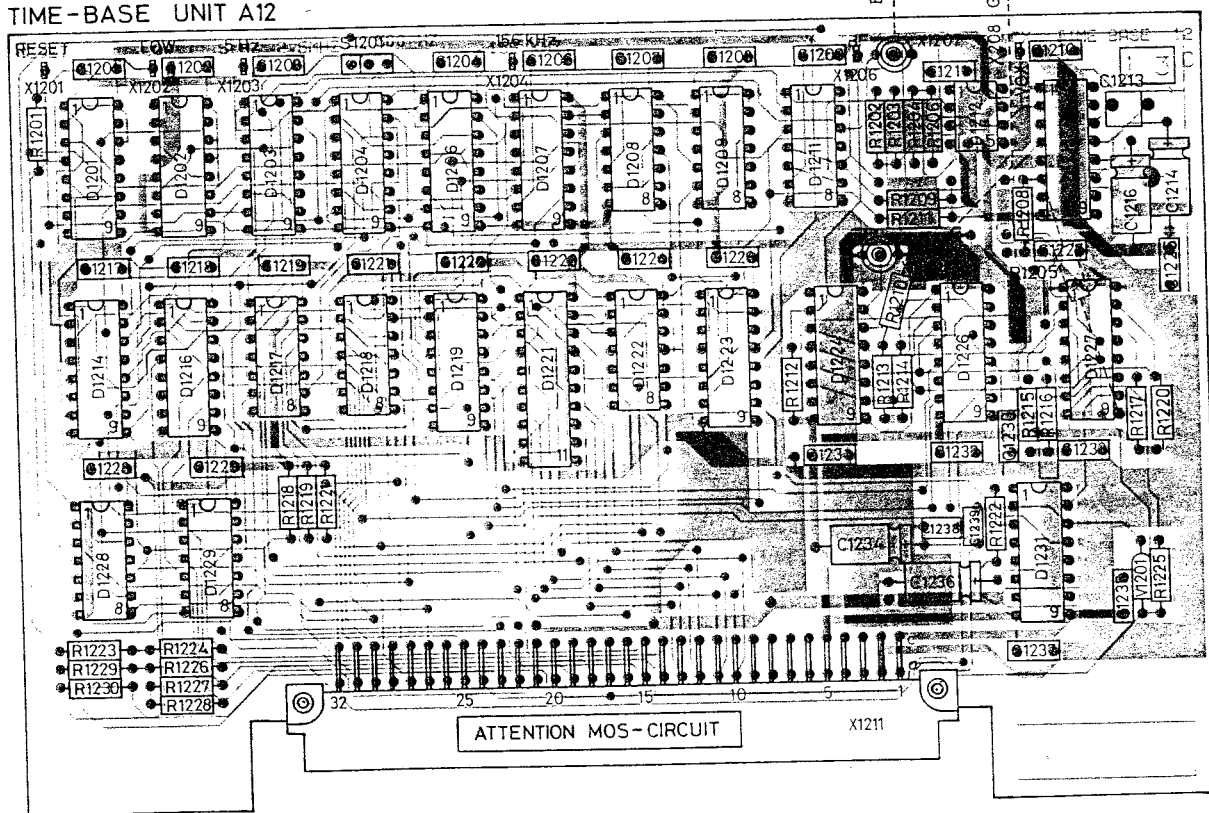

MAT1255

Fig. 6.2.56.

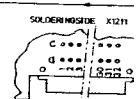
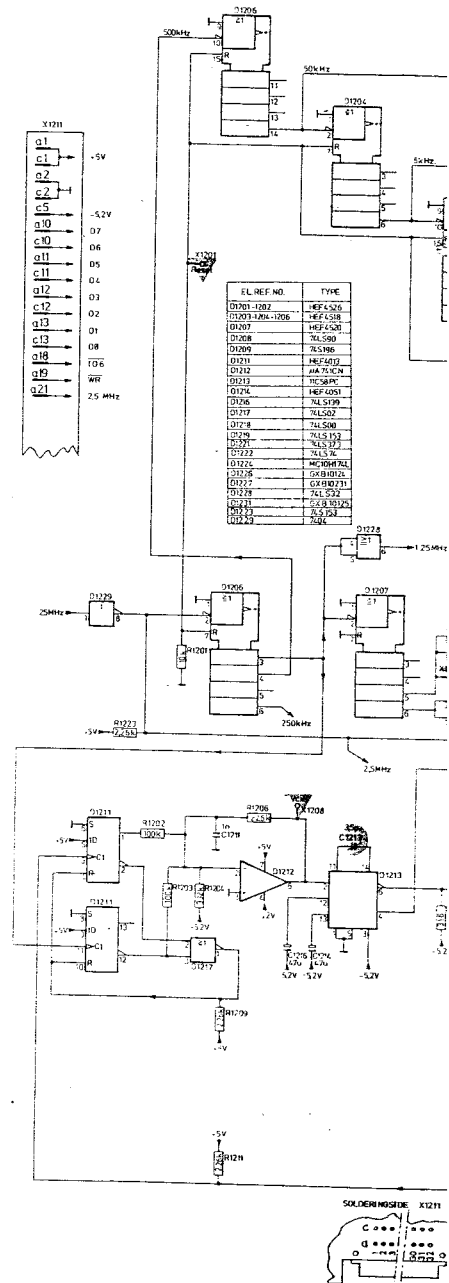

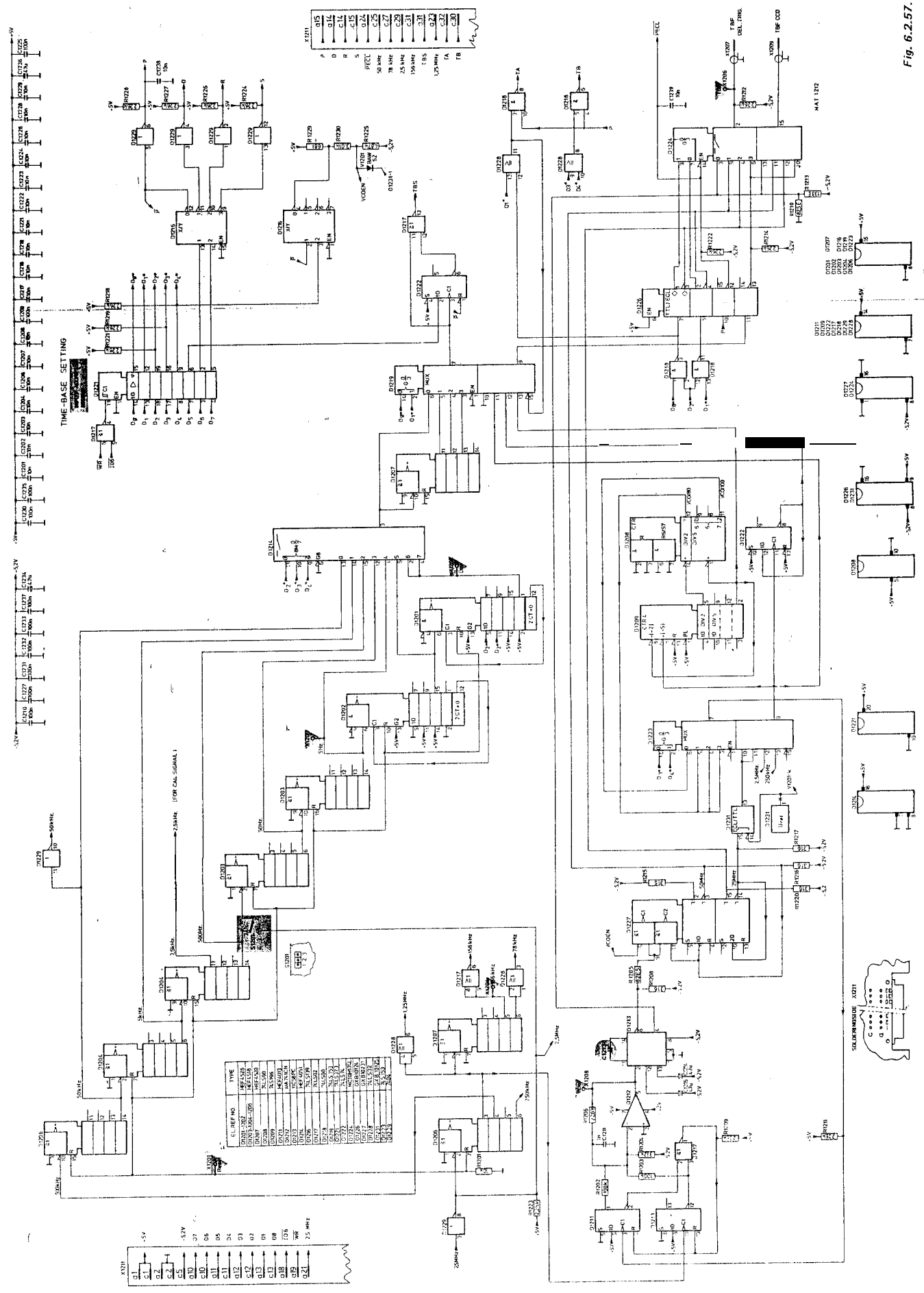

TIME-BASE SETTING

EL. REF. NO.	TYPE
D100	100K
D101	100K
D102	100K
D103	100K
D104	100K
D105	100K
D106	100K
D107	100K
D108	100K
D109	100K
D110	100K
D111	100K
D112	100K
D113	100K
D114	100K
D115	100K
D116	100K
D117	100K
D118	100K
D119	100K
D120	100K
D121	100K
D122	100K
D123	100K
D124	100K
D125	100K
D126	100K
D127	100K
D128	100K
D129	100K
D130	100K
D131	100K
D132	100K
D133	100K
D134	100K
D135	100K
D136	100K
D137	100K
D138	100K
D139	100K
D140	100K
D141	100K
D142	100K
D143	100K
D144	100K
D145	100K
D146	100K
D147	100K
D148	100K
D149	100K
D150	100K
D151	100K
D152	100K
D153	100K
D154	100K
D155	100K
D156	100K
D157	100K
D158	100K
D159	100K
D160	100K
D161	100K
D162	100K
D163	100K
D164	100K
D165	100K
D166	100K
D167	100K
D168	100K
D169	100K
D170	100K
D171	100K
D172	100K
D173	100K
D174	100K
D175	100K
D176	100K
D177	100K
D178	100K
D179	100K
D180	100K
D181	100K
D182	100K
D183	100K
D184	100K
D185	100K
D186	100K
D187	100K
D188	100K
D189	100K
D190	100K
D191	100K
D192	100K
D193	100K
D194	100K
D195	100K
D196	100K
D197	100K
D198	100K
D199	100K
D200	100K

EL. REF. NO.	TYPE
D1	100K
D2	100K
D3	100K
D4	100K
D5	100K
D6	100K
D7	100K
D8	100K
D9	100K
D10	100K
D11	100K
D12	100K
D13	100K
D14	100K
D15	100K
D16	100K
D17	100K
D18	100K
D19	100K
D20	100K
D21	100K
D22	100K
D23	100K
D24	100K
D25	100K
D26	100K
D27	100K
D28	100K
D29	100K
D30	100K
D31	100K
D32	100K
D33	100K
D34	100K
D35	100K
D36	100K
D37	100K
D38	100K
D39	100K
D40	100K
D41	100K
D42	100K
D43	100K
D44	100K
D45	100K
D46	100K
D47	100K
D48	100K
D49	100K
D50	100K
D51	100K
D52	100K
D53	100K
D54	100K
D55	100K
D56	100K
D57	100K
D58	100K
D59	100K
D60	100K
D61	100K
D62	100K
D63	100K
D64	100K
D65	100K
D66	100K
D67	100K
D68	100K
D69	100K
D70	100K
D71	100K
D72	100K
D73	100K
D74	100K
D75	100K
D76	100K
D77	100K
D78	100K
D79	100K
D80	100K
D81	100K
D82	100K
D83	100K
D84	100K
D85	100K
D86	100K
D87	100K
D88	100K
D89	100K
D90	100K
D91	100K
D92	100K
D93	100K
D94	100K
D95	100K
D96	100K
D97	100K
D98	100K
D99	100K
D100	100K

Fig. 6.2.57.

A12 TIME BASE UNIT

6.2.13. Delay trigger unit A13

The delay trigger unit comprises the following sub-circuits:

- The time-base AUTO circuit
- Plot output circuit and control signals for the dot-join circuit
- Down counters for trigger delay in Direct or P2CCD mode
- Digital-to-analog converter for trigger delay in Sampling mode

6.2.13.1. The time-base AUTO circuit

The time-base auto circuit consists of D1321 and its associated components. In the absence of the TRIST signal, i.e. no trigger pulse, and with the trigger switch in the AUTO mode, the trigger flip-flop of the ACL unit A9 requires a pulse to restart. This pulse is generated by D1321 output 4 and is referred to as the AUTRI signal.

A FRUN signal can enable the output pulse of the trigger unit A22. If no TRIST pulses are available, the re-triggerable monostable multivibrator D1321 (output 12) is at the rest position with output 12 at logic high. Together with signal AUTOTB, which is also high from the AUTO switch, output 6 of D1313 goes high. This output is the FRUN signal. As this time, D1321 output 4 is enabled and, on receipt of a CTF pulse, the AUTRI signal goes active low for 3  $\mu$ s approx. to preset the trigger flip-flop on the ACL unit

A frequency of 1.25 MHz is applied at input 1 of D1321 to ensure that an AUTRI pulse occurs.

6.2.13.2. Plot output circuit and control signals for the dot-join circuit

The X OUT and Y OUT signals derived from the final amplifier unit A20 are applied to the sample-and-hold gates D1328 and D1329. At a particular moment, determined by the software, the data line D3 goes high for 30  $\mu$ s approx. and D1328 and D1329 respectively will now hold the instantaneous values of X OUT and Y OUT for 17 ms approx. The outputs of the sample-and-hold gates are buffered by operational amplifiers D1319 and D1331 to obtain output voltages of 1 V full-scale for X and Y plotting.

The pen-lift circuit is controlled by a high level on data line D4 at the moment that D1318 is enabled. Changeover of the soldered dot-connection between D1323 and R1334 gives the possibility of active high or active low pen-lift operation. The output is an open-collector output with a maximum load capability of 1 A.

6.2.13.3. Down counters for trigger delay in Direct or P2CCD modes

The following pulses are all derived from the WR pulse by a network of dividers and logic gates, and serve to control the dot-join circuit (final amplifier A20):

Q0 and Q1: ZDJ and RESDJ, and TRSH.

The signals Q0 and Q1 control the channel separation. Signal TRSH controls the sample-and-hold gates of the dot-join, the signal RESDJ serving to control the reset dot-join for the X channel. The ZDJ signal generates the blanking pulse on the microprocessor board and discharges the capacitor of the sawtooth generator on the final amplifier unit.

6.2.13.3. Down counters for trigger delay in Direct or P2CCD modes

The input of the counters may be the signal TBF or TBS. Signal TBF is at ECL-level at a frequency of 125 KHz. ... 50 MHz. Conversely, the TBS signal is at TTL-level and at a frequency below 125 KHz. Both signals are always 25 pulses per division. The signal TBS is converted into ECL-level and applied via a wired-OR circuit to D1306, which functions as a divide-by-five circuit (output on pin 15). Via ECL/TTL converter D1307, the signal is applied to the 4-stage down counter consisting of D1308, D1309, D1311 and D1312. This system operates as follows:

The preset trigger delay in the DIV display is converted to a particular number by the microprocessor system and this number is set on the data-bus and loaded in the counters in two cycles.

First, D1308 and D1309 are loaded by enabling them (on D1308-1 and D1309-1) with pulse I08 together with address 8086 and the WR pulse. After this, D1311 and D1312 are loaded by enabling them (pins 11) with pulse I08 in combination with address 8085 and WR pulse.

The number now loaded must be counted down. The count pulses are derived from signals TBS or TBF, which may be enabled by EDCT applied via TTL/ECL converter D1303 and flip-flop D1304 to input 7 of D1306. The pulse EDCT is generated under the following conditions:

- Reset input 1 of D1317 is high.
- TRIST pulse goes high.

In this event,  $\overline{EDCT}$  goes active, so set input 5 of D1304 goes low, and on receipt of a TBS or TBF pulse at clock input 6 of D1304, output 3 goes high and enables D1306 as a five-counter. After counting down to zero, output 13 of D1312 goes low and via AND-gate D1316 (8, 9, 10) the reset input 1 of D1317 goes low and output 6, the  $\overline{EDCT}$  pulse, goes high to disable D1306.

Divider D1306 must be blocked during the new loading of the down counter. This is achieved by the pulse NTSC which remains low during loading, and D1317 reset 1 remains low. After loading, D1317 reset 1 goes high and on receipt of a TRIST pulse, signal  $\overline{EDCT}$  reverts to the active state.

If the counter is blocked, the signal DELTRG goes high via D1323 and D1316 (4, 5, 6).

**6.2.13.4. Digital-to-analog converter for trigger delay in Sampling mode**

In the sampling mode, an analog signal is required to delay the trigger. This signal is derived from the digital-to-analog converter D1327, which is loaded with the information of the data-bus when enabled by Pulse WR in combination with IO8 and address 8086.

The digital information is coded by the software and is converted into an analog voltage. This is a d.c. voltage for the time during which no change is made in the delay setting. The total delay possible in the sampling mode is 100 divisions. These 100 divisions are digitally divided into 200 steps: that is, each division delay is digitally two steps. On conversion, it is then 80 mV/division.

The function of the trigger delay is explained in the description of the trigger unit A22.

*Note: Bear in mind that the principle of the oscilloscope with a trigger delay of zero means that the DELTRIG pulse always appears 10 divisions after the TRIST pulse.*

INCOMING SIGNAL	OUTGOING SIGNAL	GENERATED ON UNIT	USED ON UNIT	DESCRIPTION
A0 - A1 - A2 AUTO TB	$\overline{AUTRI}$ AVSB	A4 A22 A13	A9 A4-6-20	Address bits from system address bus Auto signal from AUTO switch
CTF D0... D7	DACDEL DELTRG DJ	A9 A4 A13 A13 A13	A22 A9-A202 A20	logic "0" in X= A N = 8 mode Clear signal for trigger flip-flop Data bits from system data bus Output signal of DAC delay Delayed trigger signal Dot join signal
DT	ENKEL FASDJ FRUN	A4 A13 A13 A13	A20 A6 A22-A202	Display timing Single channel mode Phase on display level Freerun signal
IO8	PENLFT OO - O1 RESDJ	A4 A13 A13 A12 A12	OUTPUT A20 A20	I/O address decoding signal Penlift Control signals for dot join Reset dot join Time-base fast Time-base slow
TBF TBS TRIST	TRSH	A22 A13 A4 A20	A20	Trigger signal for stretcher Trigger for dot join sample & hold Signal WRITE from microprocessor
WR X OUT	X PLOT Y EX	A13 A13 A20	OUTPUT A20	Horizontal output signal Horizontal plot output signal Y-expand
Y OUT	Y PLOT ZDJ	A13 A13 A12 A4 A15 A15 A15 A15	OUTPUT A4-A20	Vertical output signal Vertical plot output signal Z dot join
1.25 MHz 2.5 MHz +5v -5.2V +12V -12v				

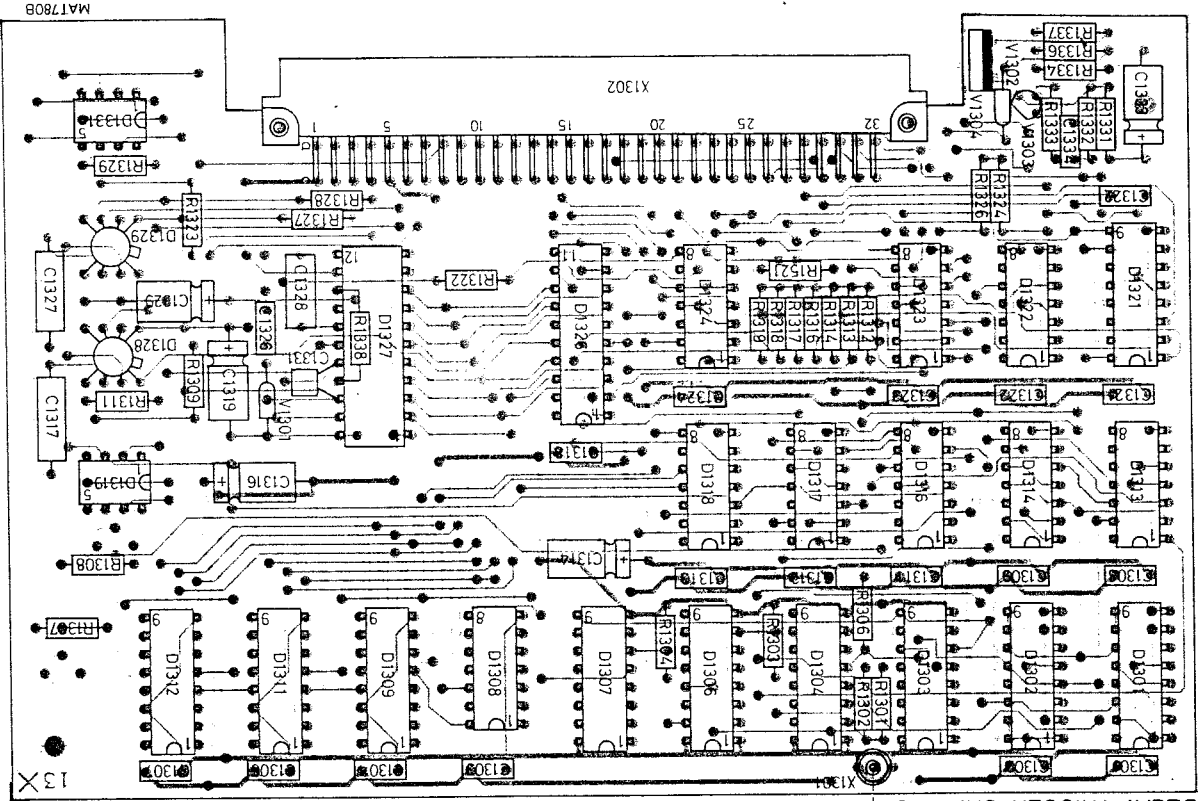
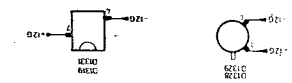
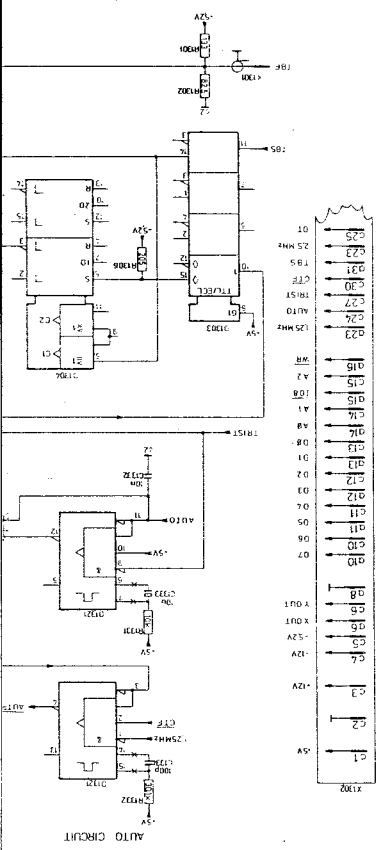
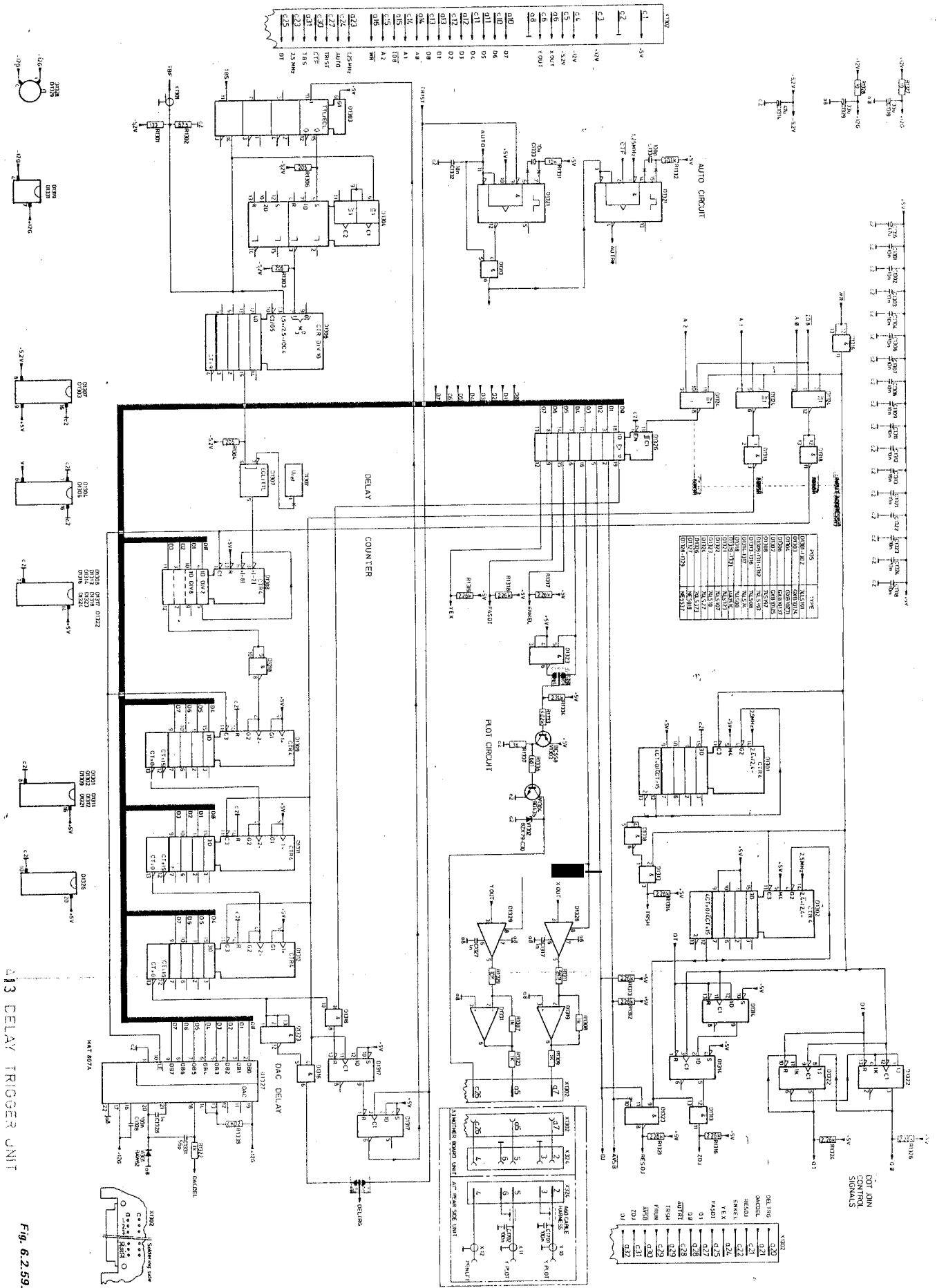

Fig. 6.2.58.





433 DELAY TRIGGER UNIT

Fig. 6.2.59.

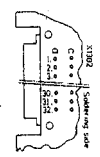

#### 6.2.14. I.E.C. unit A14

There is a connector X1401 available on the motherboard unit A3 in which no plug-in unit is placed. Here the I.E.C. bus interface option PM 3325 can be placed.

For mounting instructions refer to the sheet which is delivered with the PM3325.

- PM3311C instruments are already provided with an I.E.C. unit A14
- For service spare parts refer to chapter 12 "PARTS LISTS".

#### 6.2.14.1 General description (refer to block diagram).

An IEC bus line interface is used in **multidevice** systems to connect the **instruments** in parallel to the same interface lines. Each instrument has its own specific address (selected with switches in the instrument) so that an instrument is only listening after it has received its specific address, in IEC terms is called **My listen Address (MLA)**. The listen addresses are generated by the controller of the **system** (e.g. a computer) and are transmitted via the data lines of the bus during an address or interface message the attention line (**ATN**) is active to indicate that the information on the data lines have a special interface function. The **IEC bus** can be split up into three functional parts: the data bus, the handshake bus and the management bus.

- The **Data Bus** is used to transport messages for the device functions as well as for the interface functions and consists of 8 lines (**D101...8**).

- The **Handshake Bus** controls the correct transfer of data bytes with the next three signals.

**Data Valid (DAV)** indicated the condition of information on the 8 DIO lines.

**Not ready for data (NRFD)** indicates the **condition** of readiness of device (s) to accept data.

**Not data accepted (NDAC)** indicates the condition of acceptance of data by devices.

A timing diagram for the handshake cycle is shown in the figure, take notice that the cycle is as fast as the slowest instrument.

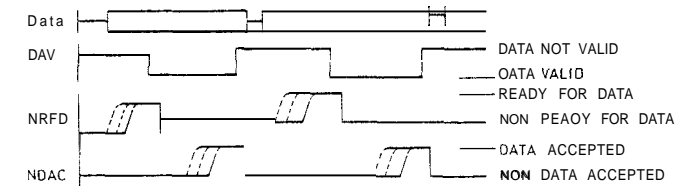

MAT838

- The management bus is used to manage an orderly flow of information **across** the interface.

Herefore the next five signals are available:

**Attention (ATN)** specifies how data on the DIO lines are to be interpreted. Active indicates a message is transferred via the data bus (for example a listen address). not active status is present during normal data transfer (for example a command for the oscilloscope).

**Interface clear (IFC)** places the interface of all interconnected devices in a known quiescent state.

**Service Request (SRQ)** indicates that one of the instruments wants the attention of the controller *forexample* to give an error message.

**Remote enable (REN)** sets an instrument to its remote-control mode, if it is in the addressed state.

**End of identify (EOI)** indicates the end of a multiple byte transfer.

**NOTE:** Because of the negative logic used for the IEC-bus the signals are "true" (active) when they have a low level, HOWEVER all signals at the lefthand of the buffers D1406-07-16-17 are given for positive logic, so "true" is a high level.

How does the interface function?

Initiation:

When the oscilloscope is switched-on, the C.P.U. reads the card code to identify which of the optional interfaces has been fitted. In this case it is the PM3325 so the C.P.U. starts with the initiation of the interface by sending control-signals to the latch D1424. The integrated circuit D1408 (HEF 4738) reads the status of the switches for MLA/MTA, TALK ONLY and LISTEN ONLY and some control signals via the two shift registers D1429 and D1431. The listen address is put into a register of D1408. Now the interface is ready to operate.

Receiving:

First the systemcontroller sends a listener address via the DIO lines (so ATN is "true"). If the address is equal to the MLA in the HEF4738, the interface becomes the listener status, this action is performed without intervention of the C.P.U. of the oscilloscope. Once in the listener state all succeeding data (without ATN="true") is read by the C.P.U. of the oscilloscope in the following way: The C.P.U. sets via the control signals latch the signal READY FOR NEXT MESSAGE to the active (low) state.

After the falling edge of the RDY signal the HEF 4738 starts with the bus handshake. First Not Ready For Data (NRFD) on connector X1402-pt8 is made high by the PM3325, so the interface is ready to receive data (for remember the IEC-bus uses negative logic). Then the controller puts data on the DIO lines and makes Data Valid (DAV) on connector X1402-pt7 "true" (=low). DAV is received by the HEF 4738 and as a result Data Valid Device (DVD) on pin 17 becomes "true" (=high). When DVD becomes high the data is latched into D1426. DVD is also supplied to the interrupt logic, so the C.P.U. of the oscilloscope interrupts its current program and checks the interrupt status D1423. DVD on pin 2 of D1423 is high, consequently the oscilloscope sets listen enable high, to inhibit interrupts caused by DVD and reads the contents of the input latch D1426. Subsequently the C.P.U. sets the signal ready for next message high and reads DVD, when DVD becomes low the C.P.U. resets the signals ready for next message and listen enable. The latter enables the DVD signal again to interrupt the oscilloscope.

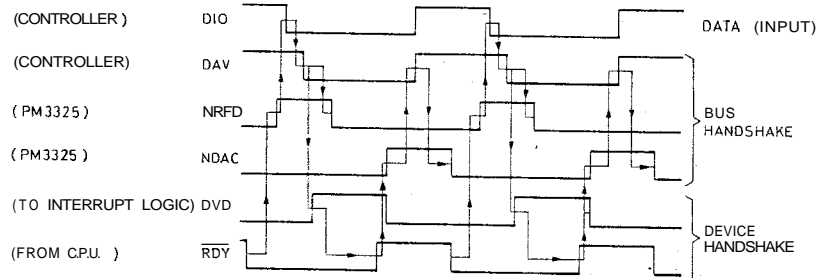

MAT 900

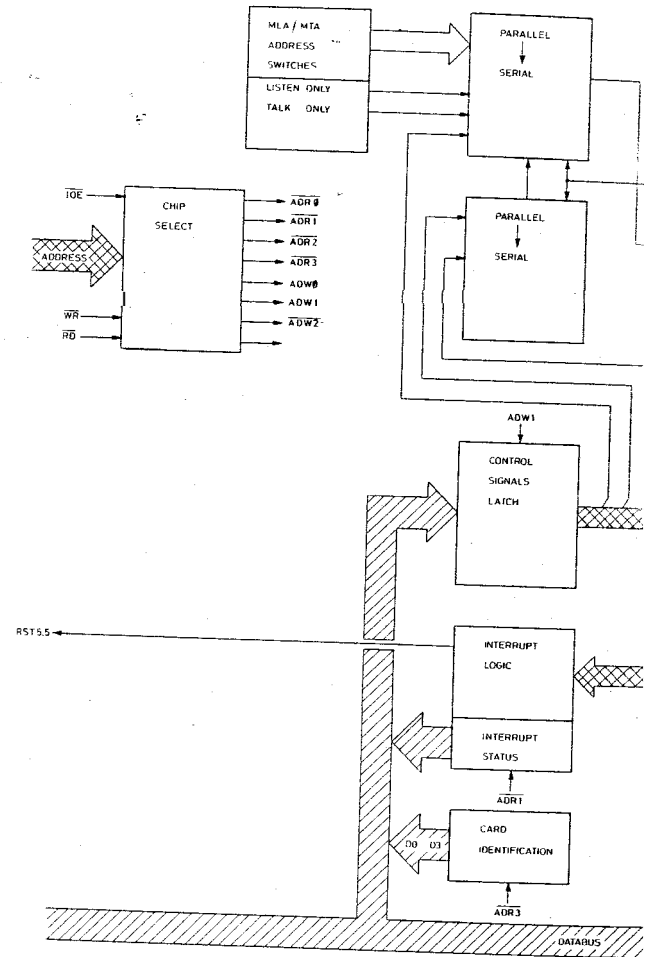



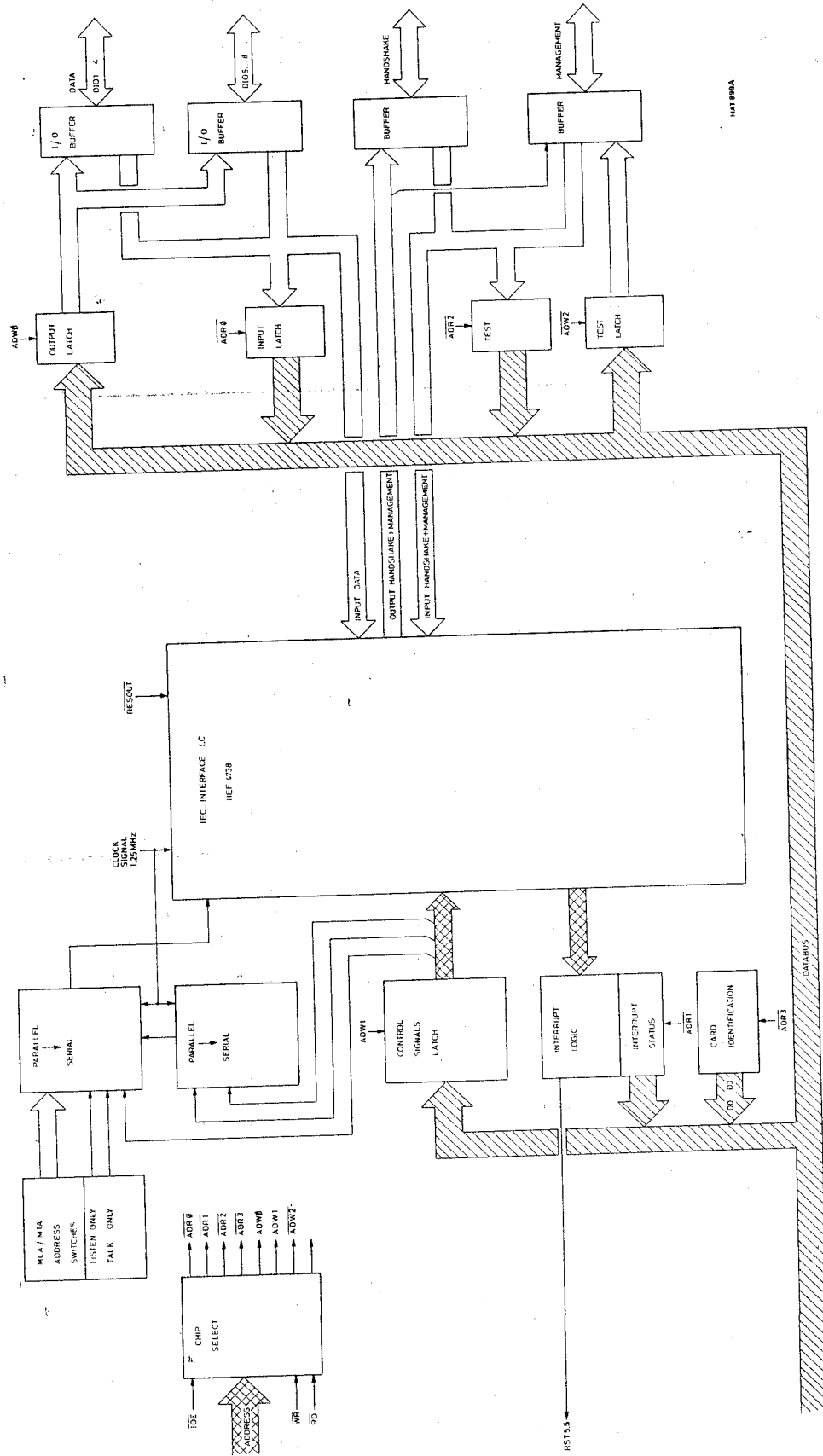

INT 899A

3  
BITS

qual  
iter-  
ue")  
the  
or  
Data  
is  
result  
id  
current  
lo-  
tech  
e DVD

(INPUT)

DSHAKE

ICE  
ADSHAKE

## Transmitting:

The PM3310 in combination with the PM3325 is capable of sending status messages to a controller in case of an error condition. If the oscilloscope has such a message, it asks the attention of the controller by means of the Service Request (SRQ) line on connector X1402-pt11. The SRQ line becomes active after the C.P.U. has set the request for service bit of the control-signals latch D1424. All the connected instruments use the same SRQ line so the controller must check which of the instruments has caused the service request. This is called SERIAL POLLING therefore the controller must address the instruments one by one as talker and read the status-byte. The seventh bit of the status-byte indicates that the corresponding instrument has asked for service, the other bits give the status condition of the Instrument. The status word is built-up as follows:

bit 8	Not used
bit 7 ... "1"	A SRQ has been given by the PM3311
"0"	No SRQ is given
bit 6 ... "1"	An ALARM is given to indicate that there is a fault condition.
"0"	No ALARM is given
bit 5 ... "1"	The PM3311 is busy with the programmed action
"0"	The PM3311 is ready with the programmed action
bit 4 ... "1"	Data on bus valid
"0"	Data on bus not valid
bit 3	} not used for PM3311
bit 2	
bit 1	
	Not used

The sequence of signals during an error condition is as follows.

First the C.P.U. activates the request for service signal of integrated circuit D1424 pin 6. The result is an active SRQ signal on connector X1402-pt11. The controller sends talk addresses, once become talker the C.P.U. puts the status-byte in the output latch and activates the signal new byte available (D1424 pin 19). Subsequently the PM3325 waits till NRFD (X1402-pt8) becomes high and then DAV (X1402-pt7) is made active (= low) and NRFD is reset by the controller.

When the controller has received the data, it makes the signal NDAC (X1402-pt9) high, the PM3325 answers with setting the DAV high and then the controller resets the NDAC signal.

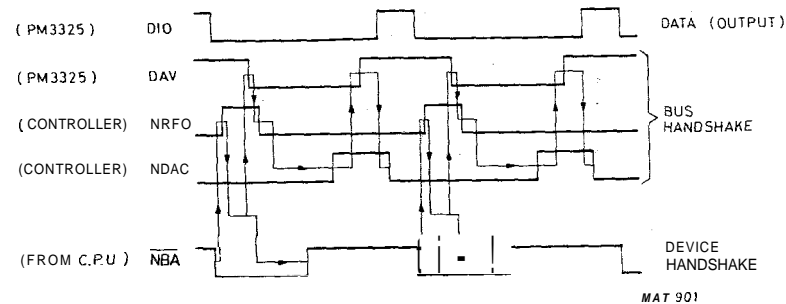

## 6.2.14.2 Chip select

To select chips of the IEC interface board the inputs of the chip select circuit must have the logic levels as given in the next table.

INPUTS					ADDRESS - BUS	OUTPUT	SELECTED FUNCTION	
$\overline{IOE}$	A1	A0	$\overline{RD}$	$\overline{WR}$	HEX. - CODE			
0	0	0	1	0	80E0(H)	$\overline{ADW0}$	Output latch	D1427
0	0	1	1	0	80E1(H)	$\overline{ADW1}$	Control signals latch	D1424
0	1	0	1	0	80E2(H)	$\overline{ADW2}$	Test latch	D1413
0	0	0	0	1	80E0(H)	$\overline{ADRO}$	Input latch	D1426
0	0	1	0	1	80E1(H)	$\overline{ADRT}$	Interrupt status	D1423
0	1	0	0	1	80E2(H)	$\overline{ADRZ}$	Test latch	01428
0	1	1	0	1	80E3(H)	$\overline{ADR3}$	Card identification	D1428

## 6.2.14.3. Card identification

After a reset of the PM3310 or after switching-on the power, the C.P.U. of the oscilloscope checks if an optional interface has been fitted into connector X1402 (of the PM3311). This is performed by putting the hexadecimal code 80E3 on the address bus and reading the card code (0010 is the code of the PM3325) via the data bus.

"0" if an optional interface has been fitted.

## 6.2.14.4 MLA/MTA address, listen only and talk only.

With switches S1401-2-3-4-5 the listen address as well as the talk address is selected.

S1401 is the least significant bit and S1405 the most significant bit.

Do not use the code 00000 or 11111, the first is generally used as the address of the system controller the latter is the code for the commands "unlisten" and "untalk".

The MLA/MTA code is converted to a serial pattern with integrated circuit 01431 and is shifted into a register of D1408.

"Talk only" is not used if the PM3325 is used in combination with the oscilloscope "Listen only" can be used if another instrument connected to the oscilloscope is not capable to generate addresses, then that instrument must be switched to its "talk only" position.

## 6.2.14.5 Control-signals latch

Via integrated circuit D1424 the C.P.U. of the oscilloscope can control functions of the IEC-bus interface such as request for service, and the handshake between the interface board and the oscilloscope. The next table gives the signals with a description of the function.

SIGNAL	DESCRIPTION
READY FOR NEXT MESSAGE	Indicates <i>the</i> readiness of the C.P.U. to receive the next character.
LISTEN	"0" indicates that the HEF4738 (D1408) may be addressed as talker as well as listener at the same time. "1" causes an unaddressing of the listener function, when a talk address is given and an unaddressing of the talker function, when a listen address is given.
REQUEST FOR SERVICE	The oscilloscope wants the attention of the system controller.
RETURN TO LOCAL	Not used in PM3310.
TEST ENABLE	Not used in PM3310.
END OR IDENTIFY	Not used in PM3310.
LISTEN ENABLE	Signal to enable (if low) or inhibit an interrupt caused by "DATA VALID DEVICE" via D1403 pin 4.
NEW BYTE AVAILABLE	An active low signal indicates that the oscilloscope has data to be transmitted.

#### 6.2.14.6 Interrupt logic, interrupt status.

The output signal **RST 5.5** of the interrupt logic (D1419 pin 4) gives an interrupt to the microprocessor of the instrument, when the input of flip flop 01419 becomes low. Four signals can cause an interrupt in this way, namely DATA VALID DEVICE, DEVICE CLEAR, LOCAL and TALKER ACTIVE STATE. Flip flop D1419 is reset by the positive going edge of signal **ADR1** with the circuit consisting of R1402, C1421, D1411, D1412 and D1422. **ADR1** is generated by the chip select circuit when the interrupt status is read.

By reading the interrupt status the C.P.U. of the oscilloscope can check the status of the interface board after an interrupt has been received. The next table gives a survey of the status signals with a description.

SIGNAL	DESCRIPTION
DATA VALID DEVICE	"1" indicates the IEC-bus interface has received data for the oscilloscope.
DEVICE CLEAR	"1" after the system controller has transmitted the command "device clear" or "selected device clear"
TRIGGER	"1" after the system controller has transmitted the command "device clear"
LOCAL	"1" after the system controller has transmitted the command "device clear"
SERIAL POLL	"1" after the system controller has transmitted the command "serial poll enable". The signal is reset by the command "serial poll disable".
TALKER	"1" indicates that the interface board is in the talker active state
END OR IDENTIFY	"1" after the system controller has transmitted an active EOI
HANDSHAKE	Becomes "1" when the signal DAV (source transfer state) becomes true. It is reset by the signal new byte available.

The clock pulse of 1,25 MHz from the PM3310 is used for the internal synchronisation of the HEF4738 (D1408) and for the two 8 bit shift registers (D1431 and D1429).

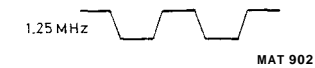

The **RESOUT** signal is used to reset the HEF4738 to initial values and to reset the flip-flops of integrated circuit D. The figure shows the signals when the instrument is switched on.

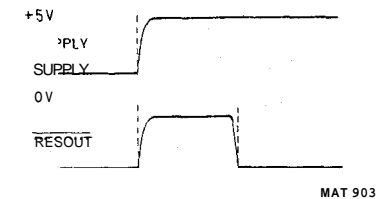

#### 6.2.14.8 Output latch, input latch.

The output data, coming from the C.P.U. of the oscilloscope, are latched into the D-flip flops of the output latch when the signal **ADW2** becomes high. The 8-bit output of the latch is continuously connected to the nand-gates in the I/O buffers D1416 and D1417 because the enable input (pin 1 of 01427) has been connected to ground.

The input data, coming from the I/O buffers D1416 and D1417, are latched into the eight D-flip flops of D1426 when the signal "Data Valid Device" (DVD) becomes high. The output of the D-flip flops is connected to the state bus when signal **ADR0** becomes low, at that moment the input data is read by the C.P.U. of the

#### 6.2.14.9 I/O buffers.

As buffers for the eight DIO lines 01416 and D1417 are used They consist of inverters, nand gates and resistors. The input data is fed to the input latch and to the HEF4738 (D1408) via the inverters. Output data, coming from the output latch is fed to the nand-gates. The output data is put on the DIO lines when the signal "TALKER ACTIVE STATE" is high. The two remaining buffers (D1406 and D1407) are used for the handshake signals and management signals. Here the enable signals for the nand gates have been connected to ground so the outputs are always enabled.

INCOMING SIGNAL	OUTGOING SIGNAL	GENERATED ON UNIT	USED ON UNIT	DESCRIPTION
A0 ... A1		A4		Address bits from system_address bus
D0 ... D7	ATN D0 ... D7 DAV D101 ... D108 EOI	A14 A14 A14 A14 A14 A4	A4	Attention; Data bits from system data bus Data available Data input/output bits End or identify I/O address decoding signal Not data accepted
<u>IOE</u>	NDAC NRFD IFC	A14 A14 A14 A4		Not ready for data Interface clear Signal READ from microprocessor
<u>RD</u>	REN	A14 A4		Remote enable Microprocessor RESET OUTPUT signal
RESOUT	RST 5,5 SRQ	A14 A14 A4 A4 A12 A15 A15	A4	Restart 5,5 signal to microprocessor Service request Signal WRITE from microprocessor
<u>WR</u> 1,25MHz +5V				

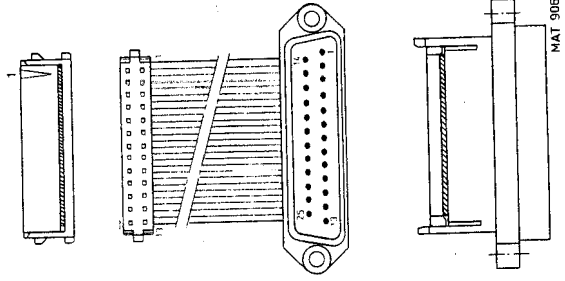

I.E.C. BUS INTERFACE UNIT A14

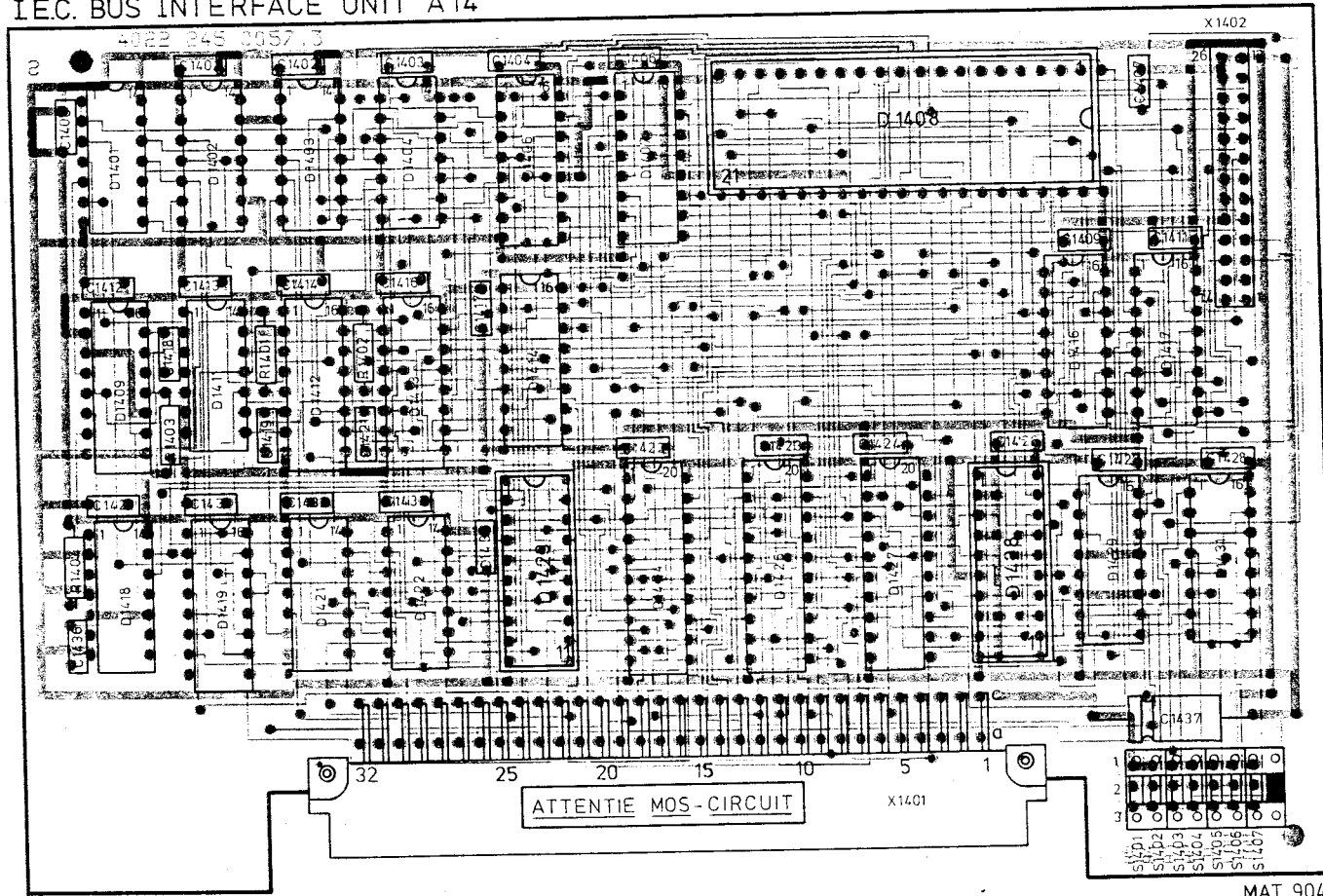

MAT 904

CHIP SELECT

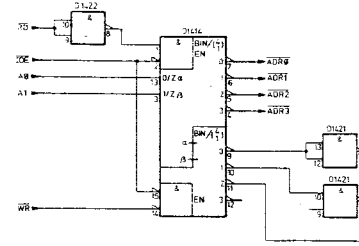

INTERRUPT LOGIC

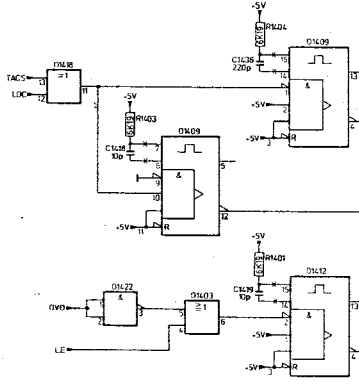

- Y1401
- a1 -5V
- a2
- a4
- a14
- a14
- a1
- a18
- a19
- a19
- a23
- a26
- a26
- a26
- a13
- a13
- a12
- a12
- a11
- a11
- a10
- a10
- a10

CONTROL SIGNALS

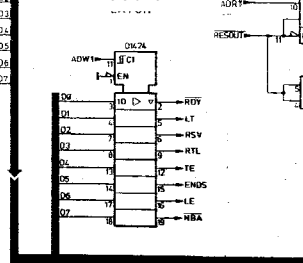

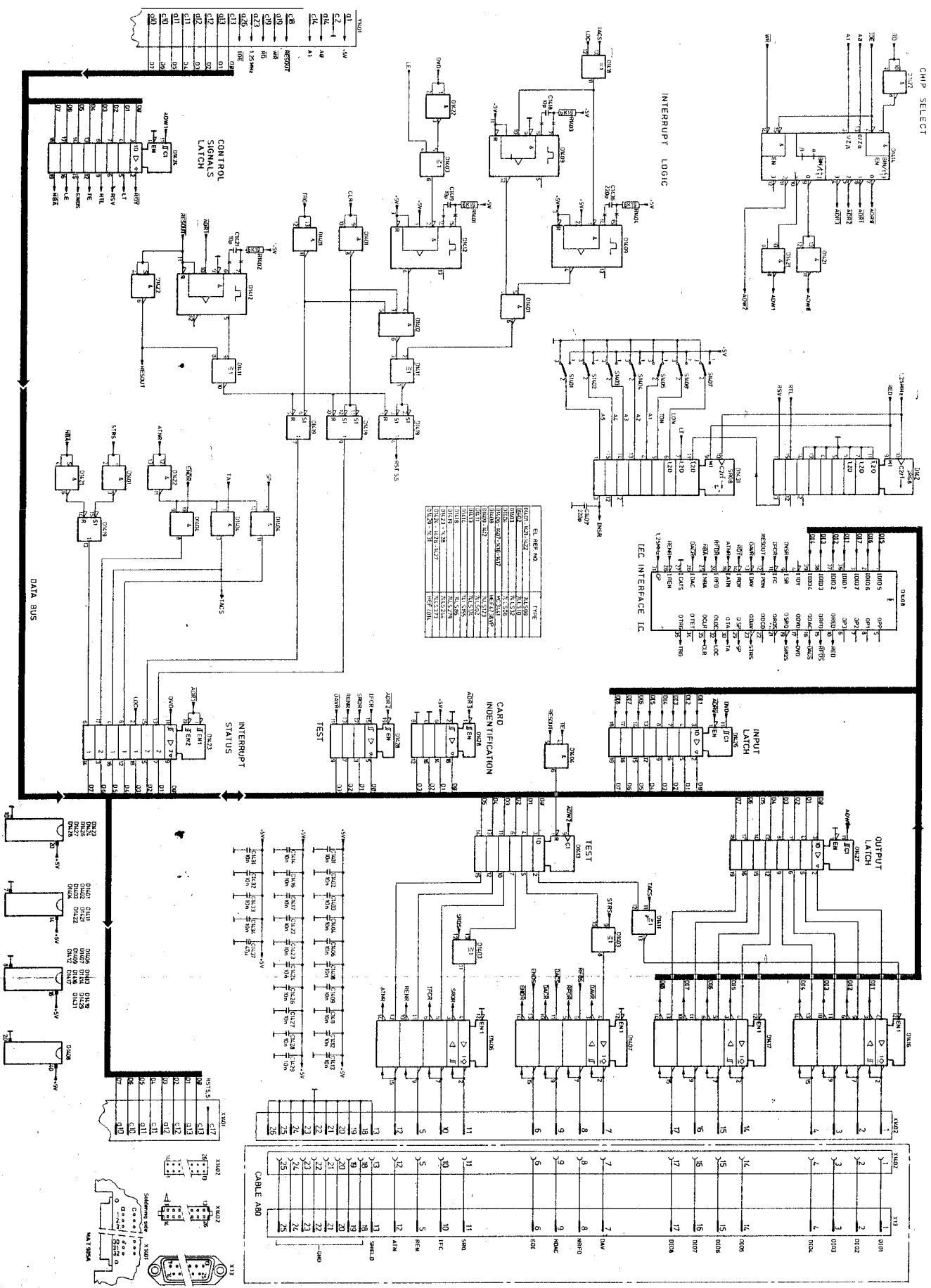

EL. REF. NO.	TYPE
001	RELAY
002	RELAY
003	RELAY
004	RELAY
005	RELAY
006	RELAY
007	RELAY
008	RELAY
009	RELAY
010	RELAY
011	RELAY
012	RELAY
013	RELAY
014	RELAY
015	RELAY
016	RELAY
017	RELAY
018	RELAY
019	RELAY
020	RELAY
021	RELAY
022	RELAY
023	RELAY
024	RELAY
025	RELAY
026	RELAY
027	RELAY
028	RELAY
029	RELAY
030	RELAY
031	RELAY
032	RELAY
033	RELAY
034	RELAY
035	RELAY
036	RELAY
037	RELAY
038	RELAY
039	RELAY
040	RELAY
041	RELAY
042	RELAY
043	RELAY
044	RELAY
045	RELAY
046	RELAY
047	RELAY
048	RELAY
049	RELAY
050	RELAY
051	RELAY
052	RELAY
053	RELAY
054	RELAY
055	RELAY
056	RELAY
057	RELAY
058	RELAY
059	RELAY
060	RELAY
061	RELAY
062	RELAY
063	RELAY
064	RELAY
065	RELAY
066	RELAY
067	RELAY
068	RELAY
069	RELAY
070	RELAY
071	RELAY
072	RELAY
073	RELAY
074	RELAY
075	RELAY
076	RELAY
077	RELAY
078	RELAY
079	RELAY
080	RELAY
081	RELAY
082	RELAY
083	RELAY
084	RELAY
085	RELAY
086	RELAY
087	RELAY
088	RELAY
089	RELAY
090	RELAY
091	RELAY
092	RELAY
093	RELAY
094	RELAY
095	RELAY
096	RELAY
097	RELAY
098	RELAY
099	RELAY
100	RELAY

CABLE A80	Pin	Signal
1	1	DATA
2	2	DATA
3	3	DATA
4	4	DATA
5	5	DATA
6	6	DATA
7	7	DATA
8	8	DATA
9	9	DATA
10	10	DATA
11	11	DATA
12	12	DATA
13	13	DATA
14	14	DATA
15	15	DATA
16	16	DATA
17	17	DATA
18	18	DATA
19	19	DATA
20	20	DATA
21	21	DATA
22	22	DATA
23	23	DATA
24	24	DATA
25	25	DATA

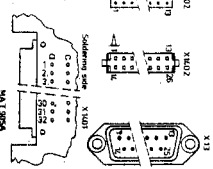

## 6.2.15. DC power unit A15

The DC power unit A15 contains the following circuits:

- DC output circuits
- High voltage converter and EHT unit
- Memory back-up circuit
- Protection circuit for the +5 V
- Cathode-ray tube circuit
- Z-amplifier circuit
- Illumination circuit
- Line signal circuit

Each of these circuits is now separately described.

**DC output circuits**

The voltages on the secondary windings of transformer T1602 on the AC power unit A16 are applied to several rectifiers and voltage doublers.

The bridge rectifiers provide for the +5 V, -5 V, +6 V, -6 V, +12 V, -12 V and +40 V supply voltages. The voltage doublers provide for the +125 V and -125 V supplies.

A -5 A supply voltage is derived from the -12 A via D1501.

A +6.5 V supply is derived from the +12 A by R1561, C1547 and V1544.

A +94 V supply is derived from the +125 V via R1572, C1548 and zener diodes V1554, V1556.

The secondary windings providing the voltages for the various circuits in the oscilloscope are completely isolated from the mains power supply.

Each supply voltage is individually rectified and smoothed.

The filament of the c.r.t. is supplied by the 6.3 V heater voltage between  $f_1$  and  $f_2$ .

**High-voltage converter and EHT unit**

A sine-wave converter formed by transformer T1501 and V1501 converts the +40 V d.c. into 1500 V a.c. with a frequency of approximately 30 kHz.

This voltage is applied to a voltage multiplier on EHT unit A23. The output voltage of this multiplier, 6.5 kV, is applied to g8 of the c.r.t.

Furthermore, the converter output of 1500 V is also rectified and smoothed by V1502, C1502, R1514 and C1503 and applied to the c.r.t. cathode. It is also fed back to the positive input of operational amplifier 01503 to stabilise the cathode voltage of the c.r.t. and thus prevent any variations in c.r.t. sensitivity.

A reference voltage, obtained from divider R1578, R1591 and R1577 is applied to the negative input pin 2 of operational amplifier D1503.

The resulting voltage on pin 6 of D1503 now controls the high-voltage converter via R1526.

**Memory backup circuit**

Two 1.5 V batteries can be fitted in the instrument for memory back-up.

When this battery back-up facility is used, the information that was stored in the random-access memories (RAMs) before switch-off (i.e. signal information and switch settings) is saved when the POWER switch is OFF.

The RAM memories are normally supplied by the voltage +5 EATT, which is derived from the +5 V via transistor V1549 when the instrument is switched on. In this case, the batteries are protected by diode V1546. When the POWER switch is OFF, the supply for the RAM memories is obtained from the batteries via V1546.

**Protection circuit for the +5 V**

This circuit protects the TTL circuits in the instrument from damage caused by an excessively high +5 V supply. When, for some reason, the +5 V supply increases to a value above 6 V approx., this +5 V supply is switched off by thyristor V1551 under the control of SCS V1527.

### Cathode-ray tube circuit

In addition to the c.r.t., this circuit includes the intensity, focus, astigmatism, trace rotation and geometry controls.

#### C.r.t. controls

By means of the front-panel INTENS potentiometer R15, the intensity of the display can be continuously controlled.

- Focussing of the trace is only possible by means of the internal FOCUS potentiometer R1506 (coarse control) and R1588 (fine control).

Trace rotation is achieved by the trace rotation coil circuit. The coil is mounted inside a metal screen and provides a magnetic field for rotational control of the entire scan. The degree and direction of rotation is determined by the setting of the TRACE ROTATION front-panel preset R16 (screwdriver-operated). The slider of R16 is connected to the bases of complementary emitter-followers V1558, V1559. The trace rotation coil current is supplied by these transistors, only one conducting at a time depending on the setting of R16.



OPTIMUM ADJUSTMENT

The ASTIGMATISM control R1587 enables the form of the spot to be adjusted by influencing the voltage on c.r.t. grids G2/G4.



Barrel and pin-cushion distortion are automatically minimised by the signal X-Y GEM connected to G5, G6 and G7. In this way, these screening grids are connected to a potential equivalent to the mean voltage of the deflection plates. The signal X-Y GEM is generated in the final amplifier unit A20.

### Z-amplifier circuit

#### a Intensity control

The output voltage of amplifier D1502 can be varied by INTENS potentiometer R15, to give variable illumination of the c.r.t. trace.

The Z-amplifier receives an input signal ZIN which originates in the microprocessor unit A4. When necessary, the trace is blanked by this signal ZIN, which is the final outcome of a number of different blanking situations occurring in this instrument. Signal ZIN is amplified by the stage incorporating transistors V1547 and V1553. Transistor V1553 acts as a constant-current source. At the output of this amplifier the a.c. and d.c. components of the blanking signal are routed along different paths. The a.c. path is via blocking capacitor C1518 directly to the Wehnelt cylinder of the c.r.t. The d.c. component of the signal is fed to the emitters of V1541 and V1537 via a low-pass T-filter. R1571, C1555 and R1569.

The signal is modulated by a frequency of 156kHz applied to V1541 via diode V1552. The resulting a.c. voltage on the collector of V1537 has a peak-to-peak value that depends on the output voltage of the low-pass filter.

The a.c. collector voltage of V1537 is applied via a symmetrical emitter-follower V1526, V1533 to a peak detector. This peak detector (C1522, V1517, V1516, R1518 and C1516) rectifies the a.c. voltage. Finally, this rectified voltage is added to the cathode voltage and applied to the Wehnelt cylinder G1.

The signal is split into its a.c. and d.c. components in order to isolate the cathode and Wehnelt cylinder, which stand at -1500V, from the other circuits.

Adjustment of the black level is achieved by potentiometer R1589 in the emitter circuit of V1537 in the d.c. amplifier.

#### b. Focussing control

The electron beam is focussed using internal focus potentiometer R1588, which controls the emitter voltage of transistors V1539 and V1536. The signal is modulated by a frequency of 156kHz applied to V1539 via diode V1552. On the collector of V1536 a signal is produced, the amplitude of which depends on the position of potentiometer R1588 (and R15 INTENS).

The a.c. voltage on the collector of V1536 is applied via symmetrical emitter-follower V1524, V1532, to a peak detector. This peak detector (C1521, V1514, V1513, R1516 and C1514) rectifies the a.c. voltage. Finally, this rectified voltage is added to the voltage set by potentiometer R1506 (part of a voltage divider network across the high-voltage converter output) and then applied to the focussing anode g3 of the c.r.t. In this way, the focus voltage also depends on the position of the INTENS potentiometer, which determines the voltage across the divider network R1502, R1506, R1509. This provides a measure of compensation, so that the focus of the electron beam is automatically adapted when the intensity of the trace is varied.

### illumination circuit

The graticule can be illuminated by the indicator lamps E1 and E2. The intensity can be varied by the front-panel ILLUM potentiometer R14, which controls the base, and hence the collector current of transistor V1561, which flows through the lamps. Note that the illumination circuit is not short-circuit proof.

### Line signal circuit

The line signal circuit produces a sine-wave voltage for mains triggering that is derived from the input mains voltage.

Photocoupler O1602 on unit A16, which provides isolation between the mains voltage and the oscilloscope circuits, drives the V1564 circuit into saturation, which means that the square-wave voltage appearing on its collector has the same amplitude value for all mains voltages.

The original sine-wave is reconstructed by means of an integrator network R1553, R1551, R1536 and C1546, C1543, C1541.

This signal, LINE, is applied via V1523 and V1531 to the trigger selector.





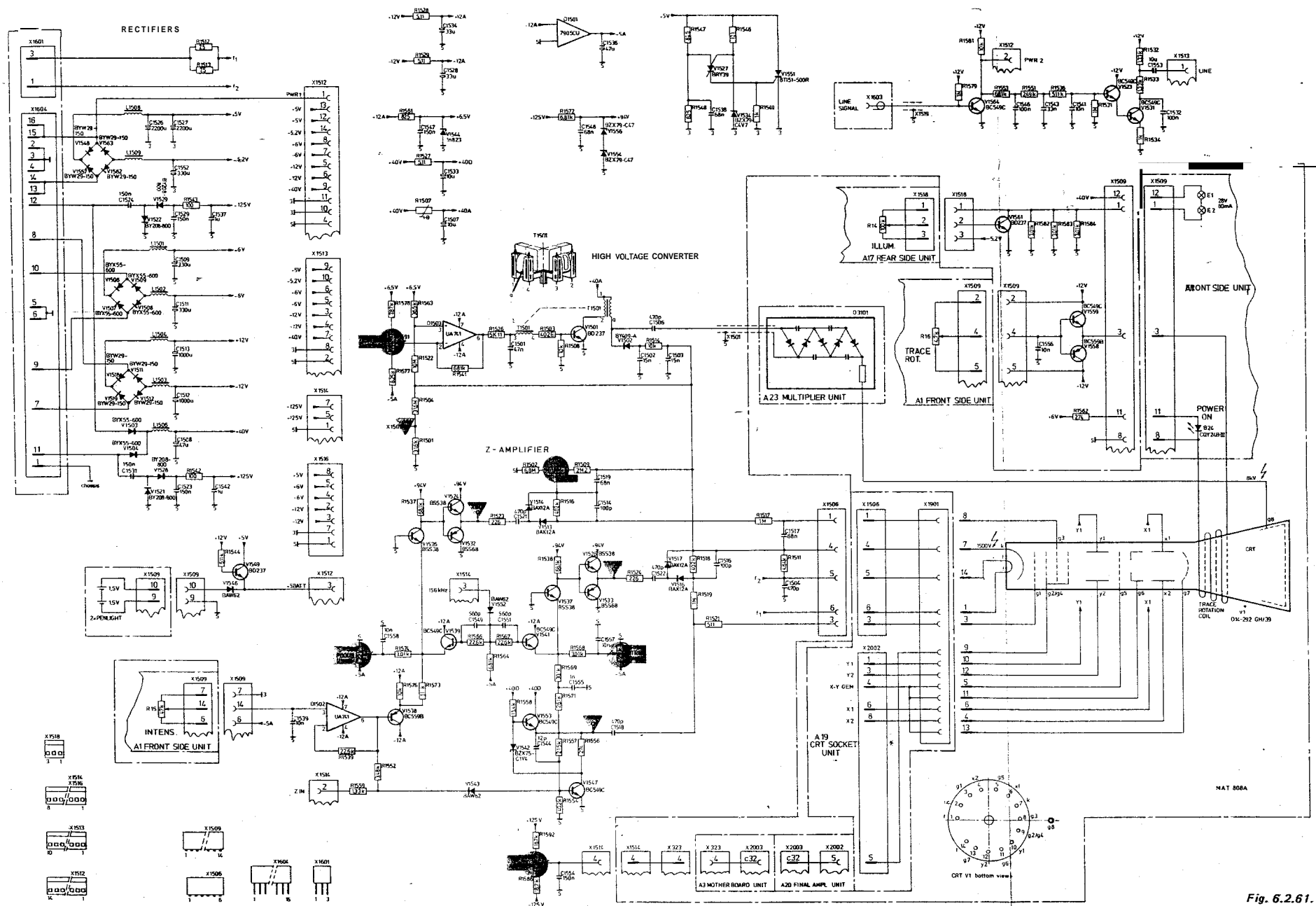

Fig. 6.2.61.

A 15 DC POWER UNIT

**6.2.16. AC power unit A16**

The A.C. POWER UNIT comprises a bridge rectifier, a d.c. to a.c. converter regulator and a transformer. Rectifier circuits for the different supply voltages are located on D.C. POWER UNIT A15.

**Input circuit**

The incoming mains voltage is fed via a double-pole POWER ON/OFF switch S40, fuse F1701 (2 A delayed action) and mains filter D1701 to the mains rectifier circuit.

This mains rectifier circuit can be matched to one out of two input voltage ranges (115 V or 230 V range) with the MAINS ADAPTER SWITCH S45 on the rear panel of the instrument.

The two-position switching enables the instrument to operate at any mains voltage between 100V and 120V  $\pm$  10% (115 visible in MAINS ADAPTER SWITCH window) and between 220 V and 240 V  $\pm$  10% (230 V visible in window).

**Note:** The same 2A delayed-action fuse is applicable for both settings of the mains adaptor switch

The mains voltage is rectified with the diode bridge V1602 and smoothed by capacitors C1606 and C1604, which form a voltage doubler in the 115 V range of S45 and a standard bridge rectifier circuit in the 230 V range of S45.

The voltage across the series circuit of C1606 and C1604 is 250 V to 400 V for both mains voltage ranges.

**Switching circuit**

The unregulated d.c. voltage is applied in the form of pulses to a resonant circuit consisting of the primary coil of the converter transformer T1602, combined with C1602 and C1603, via switching transistor V1618. The sine-wave voltage (approx. 800 V<sub>p-p</sub>) across the primary coil of T1602 is kept constant by regulating the duty cycle of the base current of V1618.

The primary coil of T1601, which is in series with the switching transistor, limits the current through this transistor.

The energy stored in T1601 is fed back to the mains rectifier circuit, during the cut-off time of V1618, via diode V1601.

Diodes V1608 and V1609 eliminate the dissipation through transistor V1618 during the switching period; instead of this, these losses are dissipated in R1604 and R1603.

Diode V1617 improves the base drive for V1618.

**Regulator circuit**

The regulator circuit consists of integrated circuit 01601 (type TDA 1060), the output (pin 15) of which supplies a square-wave current with a variable duty-cycle to the base of transistor V1616. The signal on the collector of this transistor is applied to switching transistor V1618 via transformer T1603.

The regulator circuit is controlled by the following:

- Feedback voltage (pin 3)  
This is the regulator control voltage derived from the rectifier circuit in the feedback winding of T1602. The value of this control voltage depends on the setting of R1646.
- Feed-forward voltage (pin 16)  
This voltage is derived from the mains voltage and provides direct compensation for mains variation
- Overvoltage protection (pin 13)  
A voltage is also derived from the mains voltage, via zener diode V1613, to inhibit the regulator output at excessive mains voltages (the level on pin 13 is 600 mV).
- Current limiting (pin 11)  
The voltage drop across the current-sense resistor R1627 controls the regulator circuit in the event of overload.

- Frequency adjustment (pin 7)

The value of resistance between pin 7 and earth determines the converter frequency. Preset R1647 should be adjusted for a frequency of 20 kHz approximately, i.e. the resonant frequency of C1602, C1603 and the primary coil of T1602.

During normal working, the power supply for the regulator circuit is provided by the rectifier connected to the feedback winding of T1602. Transistor V1622 then conducts, therefore V1621 does not give any current output.

**Switching-on and switch-on protection**

At the moment of switching-on the instrument, no supply voltages are immediately available in the regulator circuit from T1602. Transistor V1622 is not yet conducting, therefore transistor V1621 is fully conducting and the regulator derives its current via R1616 and R1631. As soon as the converter circuit is working, transistor V1622 conducts and V1621 blocks.

In the event of the instrument giving no converter voltage at switch-on (due to a possible defect), the PTC resistor R1631 warms up and so reduces the current through transistor V1621 to a safe level.

**Output circuits**

Various supply voltages are derived from the secondary windings of transformer T1602. These supplies are generated on D.C. POWER UNIT A15.

**Photocoupler circuit**

To enable triggering on a mains signal, this circuit produces a signal derived from the mains voltage.

Photocoupler D1602 provides isolation between the mains voltage and the oscilloscope circuits to produce a safe triggering signal. This output signal is applied to transistor V1564 on unit A15, which is driven into saturation to give a square-wave voltage on its collector. This square-wave has a constant amplitude for all mains voltages.



NAT 800A

Fig. 6.2.63.

A18 AC POWER UNIT

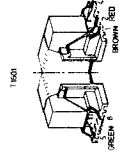

6.2.17. Rear side unit A17

The rear side unit consists of an aluminium rear cast on which the following items are mounted.

- ILLUM. control R14 - ON/OFF switch S40
- Mains filter Z1701
- BNC output sockets X10-X11-X12 for PLOT output signals
- Fuseholder F1701 and fuse.

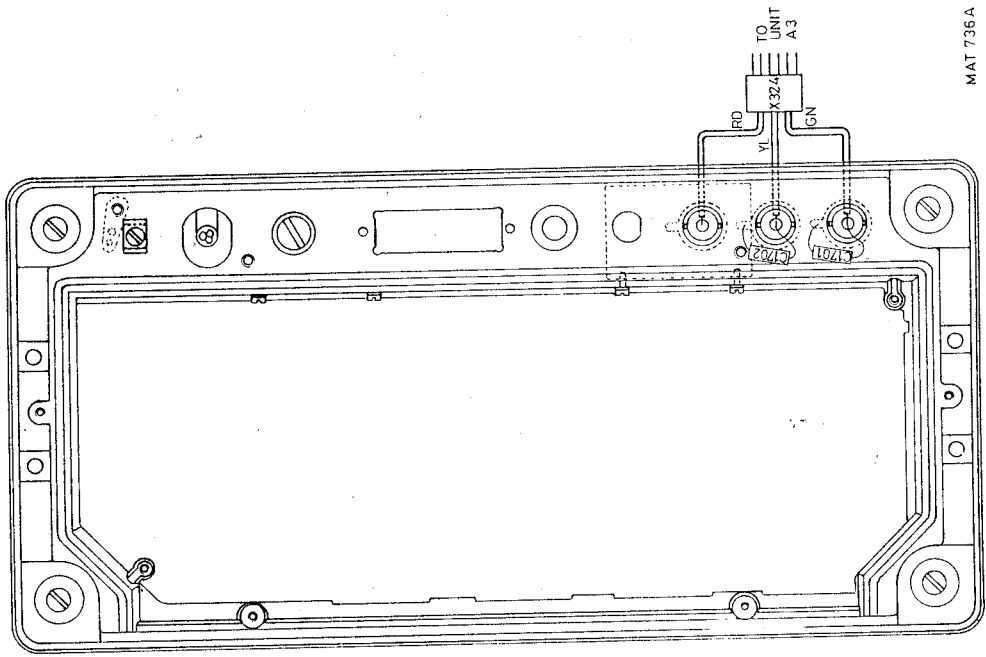
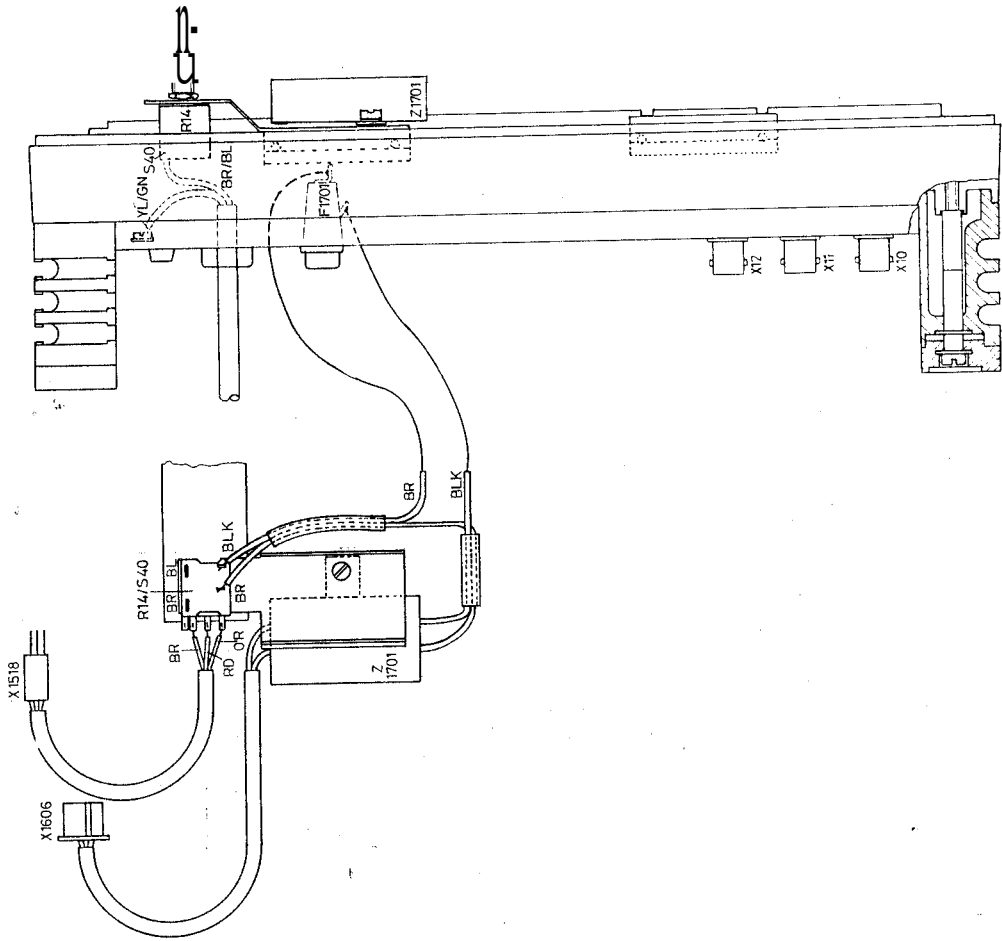

MAT 736A

Fig 6.2.64.

6.2.18. Delay line unit A18

Unit A18 is the delay line unit, which is mounted in the instrument under the C.R.T.

The unit is electrically connected between the channel switch and the delay line compensation amplifier on unit A21.

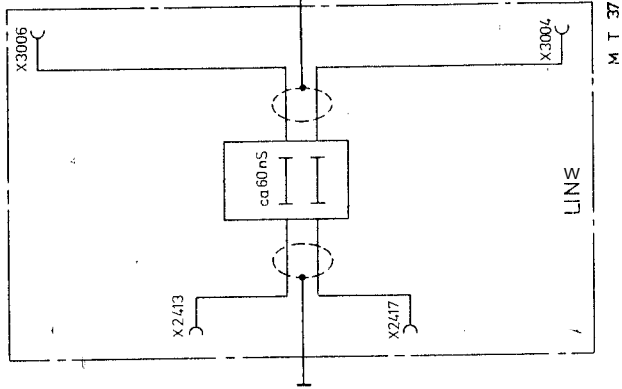

Fig. 6.2.65.

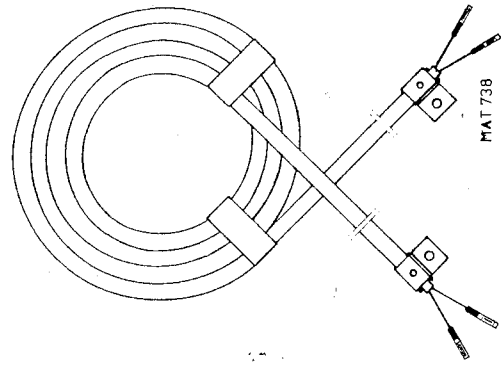

Fig. 6.2.66.

6-174

6.2.17. Rear side unit A17

The rear side unit consists of an aluminium rear cast on which the following items are mounted.

- ILLUM. control R14- ON/OFF switch S40
- Mains filter Z1701
- BNC output sockets X10-X11-X12 for PLOT output signals
- Fuseholder F1701 and fuse.

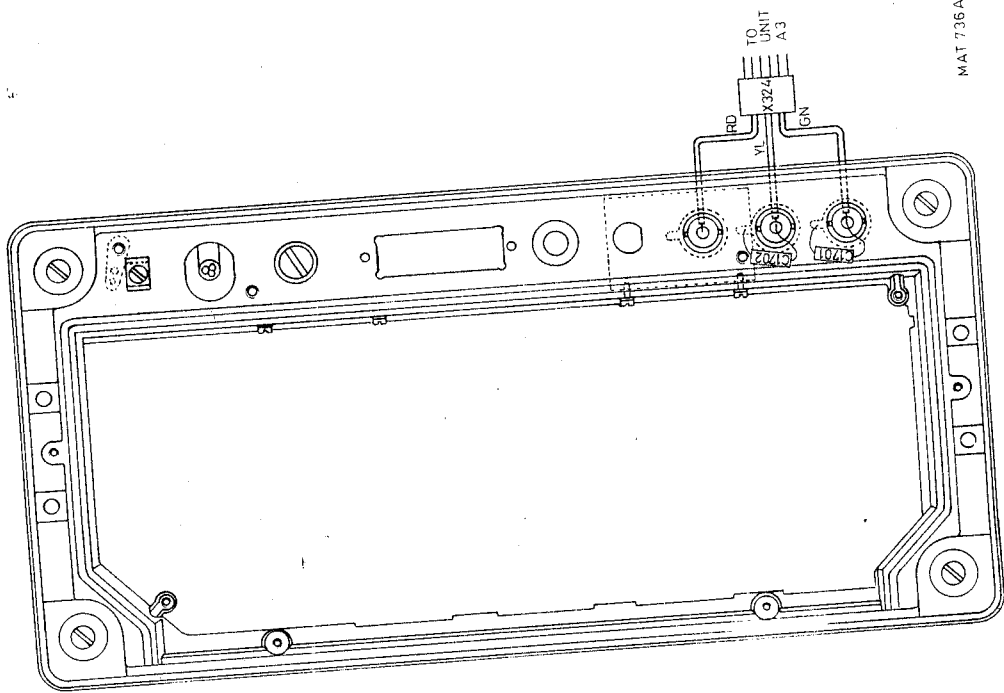
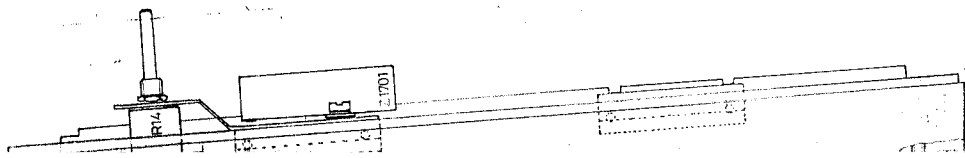

Fig. 6.2.64.



6.2.19. C.R.T. socket A19

The C.R.T. socket unit A19 consists of the socket itself (X1901) and two cables with the connectors X1506 and X2002.

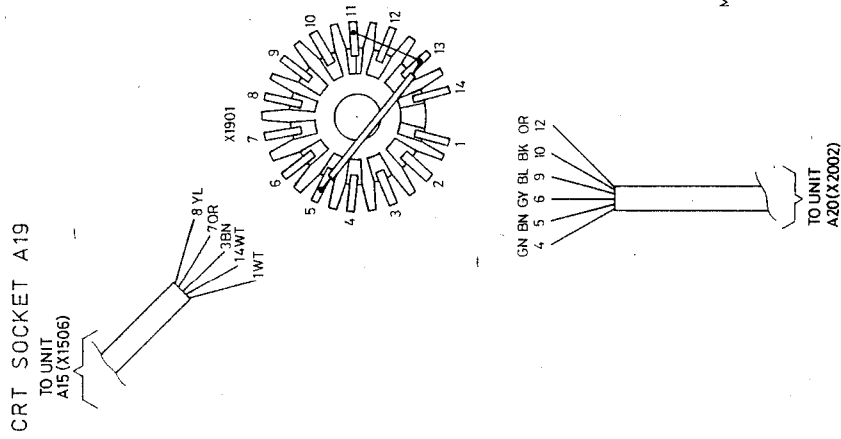
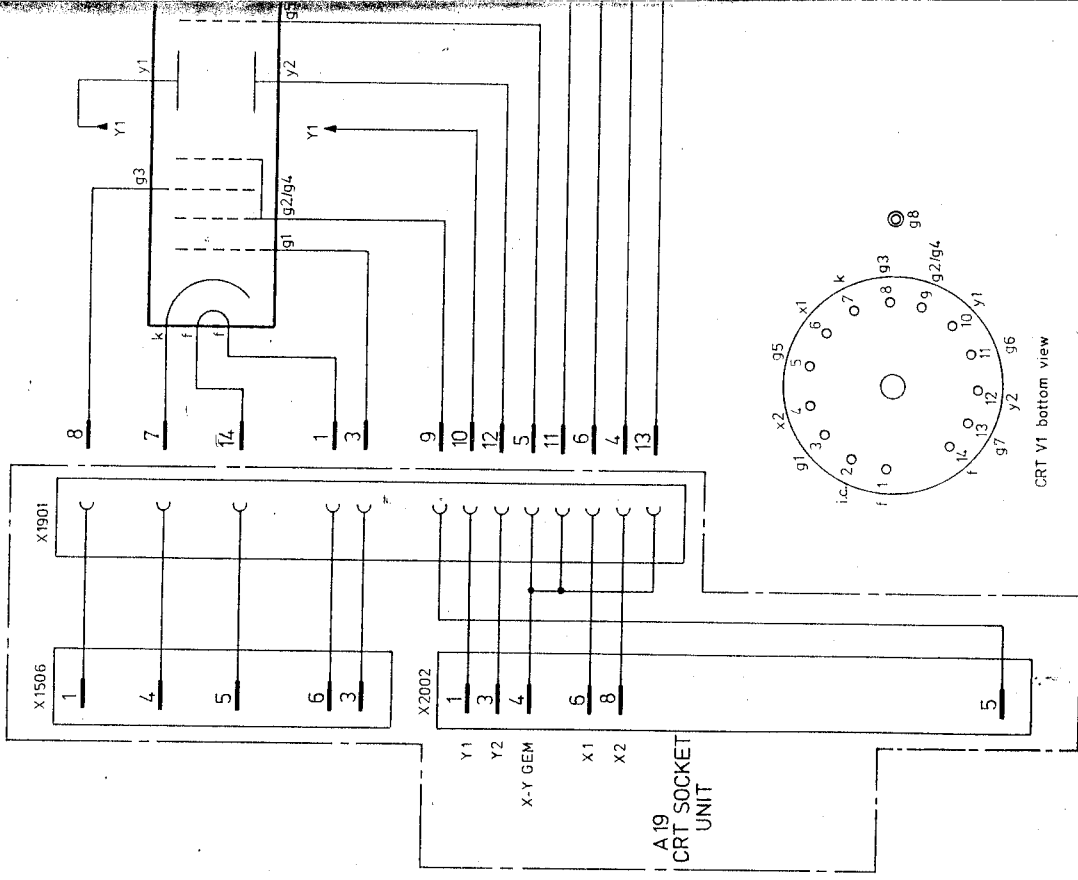

Fig. 6.2.67.









At pin 3 of D2023 the X OUT signal is available.

This signal may be:

- with no DOT-JOIN facility, a staircase voltage.
- with DOT-JOIN facility, a staircase voltage with a sawtooth voltage on every stair

#### 6.2.20.2. Y-Position Control System

In the two modes Yx1 and Yx5, a different method of position control is employed for each.

##### Yx1 mode

In this mode, two different voltages are added to the signal at the summing point (D2001-2):

- A preset voltage for position determination of the displayed memories on the c.r.t. screen.
- An adjustable voltage to position the displayed memories on the screen.

The preset voltage is selected by multiplexer D2012 output 13 and applied to the summing point via D2008 and buffer amplifier D2002 (5.6.7).

The selection of the corresponding memory is controlled by the OER0 ... OER2 signals generated on RAM unit A6.

The adjustable voltage is selected by multiplexer D2012 output 3 and applied to the summing point via buffer amplifier D2002 (1,2,3).

The YOUT signal is applied via D2008 output 12 and R2036 to the summing point if YEX is 0, as is the case in the Yx1 mode.

##### Yx5 mode

The preset voltage must not be added in the Yx5 mode, since the base-line of all displayed memories is now situated on the centre-line of the c.r.t. screen (Y POS controls at mid-range position). Multiplexer D2008 is switched by signal YEX = 1 so that the output on pin 15 is connected to earth. This means that no additional voltage is applied to the summing point.

Moreover, the YOUT signal is applied to the summing point via resistors R2027 and R2023 in series. The value of these resistors is only one-fifth of R2036, so a 5 times magnified signal is applied to the summing point.

#### 6.2.20.3. Final Y Amplifier

The output of the summing amplifier D2001 (2,3,6) is applied to the differential amplifier V2001 and V2021. The constant emitter current is derived from the current source V2028 and its associated components. Variation in the collector current results in a control voltage for V2006 and V2013, which produces output signals Y2 and Y1 to drive the c.r.t. deflection plates.

#### 6.2.20.4. Final X Amplifier

To obtain the possibility of magnification in the X direction, integrated circuit D2023 is used. This circuit comprises a Darlington pair input stage to obtain a symmetrical signal; a buffer stage and a continuous gain adjustment facility for X magnification and for X gain.

The final stage functions in a similar way to that of the final Y stage.

#### 6.2.20.5. CAL circuit

The lower part of multiplexer D2008 is controlled by a frequency of 2.5 kHz, derived from the microprocessor crystal frequency of 5 MHz by dividers on the time-base unit.

Input 3 of D2003 is switched between pins 3 and 5 of D2008, i.e. between 1 V and 0 V. Amplifier D2003 serves as a follower circuit with an output of 3 V, adjustable by means of R2017.

INCOMING SIGNAL	OUTGOING SIGNAL	GENERATED 3N UNIT	USED ON UNIT	DESCRIPTION
ASTIGM	STIGM	A15	A20	Astigmatism
AVSB		A13		Logic 0 in X = AIY = 8 mode
DJ		A13		Dot join signal
ENKEL		A13		Single channel mode
OER0		A6		Output enable RAM0
OER1		A6		Output enable RAM1
OER2		A6		Output enable RAM2
POS0		A202		Slider of ACCU position control
POS1		A202		Slider of STO1 position control
POS2		A202		Slider of STO2 position control
POS3		A202		Slider of STO3 position control
00		A13		Control signal for dot join
Q1		A13		Control signal for dot join
RESDJ		A13		Reset dot join
TRSH		A13		Trigger for dot join sample and hold
	X1	A20	A19	Horizontal deflection signal
	x2	A20	A19	Horizontal deflection signal
XDAC		A6		Horizontal DAC output signal
XMAGN		A202		Slider of X MAGN control
	XOUT	A20	A13	Horizontal output signal
XPOS		A202		Slider of X POSITION control
	X-Y GEM	A20	A19	Geometry control signal
	Y1	A20	A19	Vertical deflection signal
	Y2	A20	A19	Vertical deflection signal
YDAC		A6		Vertical DAC output signal
YEX		A13		Vertical output signal
	YOUT	A20	A13	
ZDJ		A13		Z dot join
2.5 kHz		A12		
+5 V		A15		
+6 V		A15		
-6 V		A15		
+12 V		A15		
-12 V		A15		
+40 V		A15		
+135 V		A15		
-135 V		A15		





### 6.2.21. Input amplifier unit A21.

#### 6.2.21.1. General

The input amplifier unit is sub-divided into the following sections, as shown in the block diagram

- Input attenuator
- Amplifier
- Channel switch and mode switch
- Delay line compensation/Track & Hold gate
- Logic circuits (control interfaces)

Briefly, the channel input attenuator reduces the input signal according to the front-panel switch settings or remote signals, and converts it from high to low impedance.

The asymmetrical output signal is applied to the amplifier section to give a symmetrical output, an amplified trigger pick-off and an offset facility. A buffer stage provides for signal inversion and offset before feeding the channel and mode switch section. Here the logic control signals are used to switch the appropriate channels and display modes to the ADC in the storage section of the oscilloscope.

#### 6.2.21.2. Input attenuator

The input stage comprises two identical attenuator circuits. For convenience, only the channel A attenuator is described.

The input signal can be either a.c. or d.c. coupled (via C2476 or K2412) to the attenuators.

Basically, the input attenuator comprises a triple high-ohmic voltage divider and an impedance converter in conjunction with a drift correction circuit. The impedance converter (V2451, V2448) provides a zero level output, adjusted by potentiometer R2643, which feeds a low-ohmic attenuator.

Overall, the attenuation of the input stage is determined by the combination of the selected sections of the two attenuators, according to the setting of the front-panel AMPL/DIV switch. The control sequence is as follows:

The position of the AMPL/DIV switch, the AC/DC switch and the '0' switch are decoded and applied to the reed relays and FET switches (D2411) via the microprocessor system. The reed relays and the FET switches determine the position of the attenuators and are controlled from two 8-bit output ports (D2424, D2426) in the logic circuit. These output ports are controlled via the data-bus and can also be controlled by the IEC-bus interface for remote operation.

The three sections of the high-ohmic voltage divider have an attenuation factor of 1.25, 12.5 and 125 times.

If the front-panel pushbutton '0' is depressed, reed switch K2411 closes and all other reed switches are open. Control for this action is via the output ports of the microprocessor system. With K2411 closed, the input signal is not connected to the attenuator and the impedance converter, via R2668 and R2578, is switched to zero level.

The low-ohmic voltage divider, following the input impedance converter, attenuates 1, 2 or 5 times. Taking the overall combinations, together with the 1 or 10 times gain of the intermediate amplifier, twelve different deflection coefficients can be chosen.

To obtain the correct frequency characteristic, the attenuator sections are shunted by capacitors. Trimming capacitors provide for the adjustment of the capacitive divider sections for a.c. voltages to the same ratio of the resistive dividers for d.c. voltages. In this way, the divider sections are independent of frequency. A diode clipper in the gate circuit of the field-effect transistor (FET V2451) protects it against excessive negative swings, the FET being inherently protected against excessive positive swings.

The high frequency path for the input signal consists of series capacitor C504 and the FET connected in a source-follower configuration. The low-frequency path comprises an operational amplifier and an error amplifier, which corrects the output signal related to the input signal of the impedance converter over a frequency range from d.c. to 1 kHz. The output of the error amplifier (D2416) is fed to the input of the operational amplifier to replace the missing low frequency portions of the signal. In this way, the drift is reduced to a minimum.

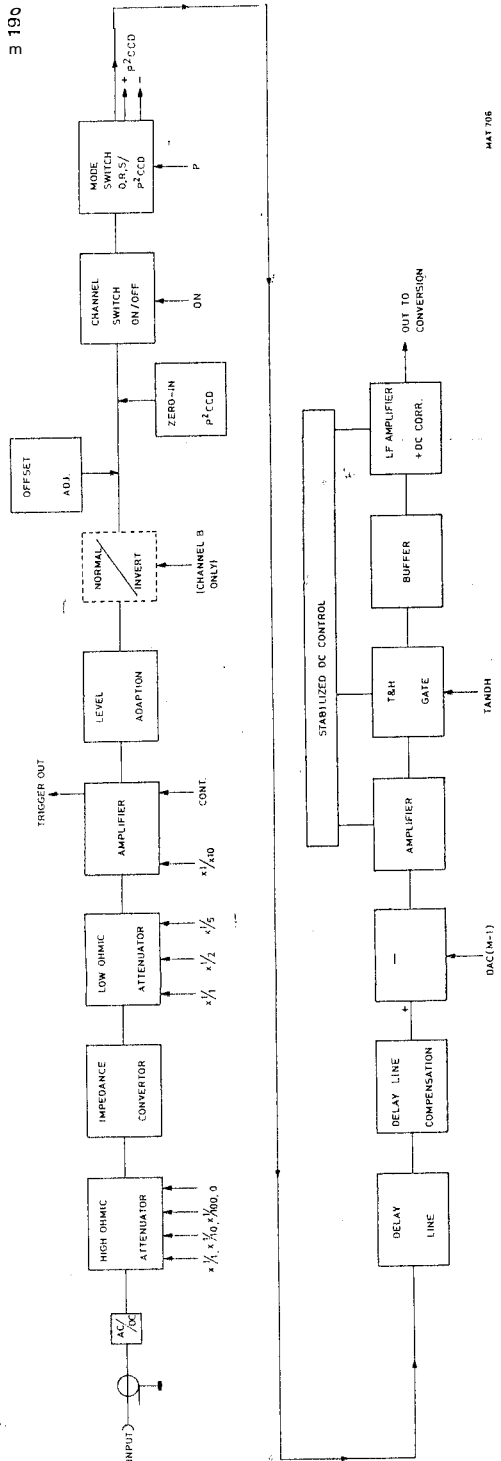

Fig. 6.2.72.

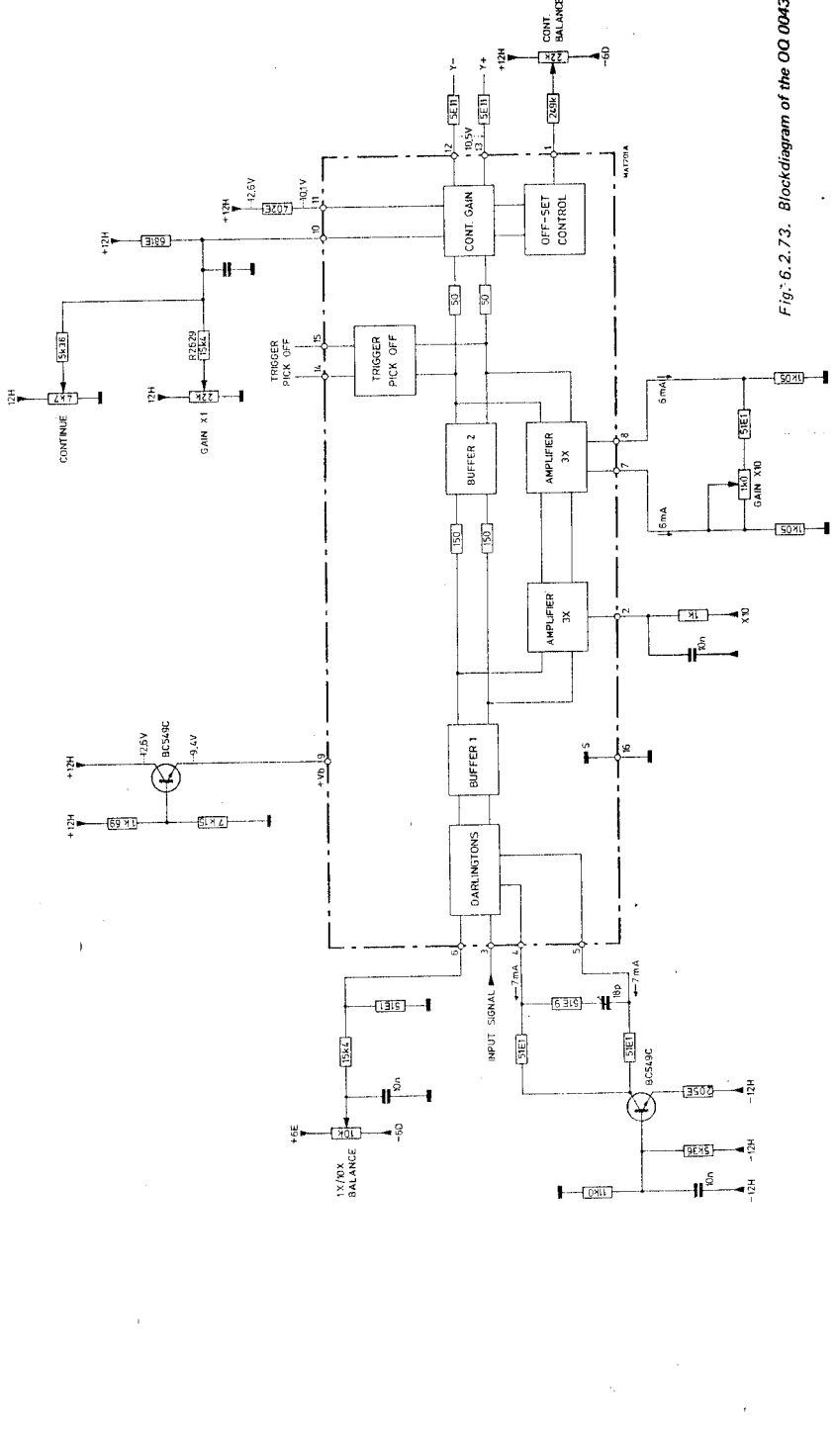

Fig. 6.2.73. Blockdiagram of the 00 0043

The output of the impedance converter is applied to the 1,2 or 5 times voltage divider. The dividing factors are controlled by FET switches (D2411), which in turn are controlled via operational amplifiers (D2421), by the output ports of the microprocessor system.

### 6.2.21.3. Amplifier

#### a. Pre-amplifier

The output of the 1-2-5 divider stage is asymmetrically applied to pin 3 of pre-amplifier 02413 (OQ 0043). The block diagram of the OQ 0043 is given in the figure and is drawn with the relevant components as mounted in this oscilloscope.

The supply voltage is routed via a temperature-compensating circuit connected to pin 9. The OQ 0043 consists of input Darlington pairs to provide a symmetrical signal from the asymmetrical input; a buffer stage; two x3 amplifiers in series and switched in parallel to a buffer stage; trigger pick-off after amplification; a continuous gain adjustment facility and an offset adjustment for the continuous control

#### b. Buffer stage

The output of the OQ 0043 is symmetrically applied to a buffer stage. In order to obtain the inverting mode for Channel B (PULL FOR -B), the buffer stage in this channel is provided with two extra transistors (V2419, V2424).

If the channel B invert switch is pulled, the microprocessor system decodes this setting and applies a high voltage to the base of V2408, which conducts.

Consequently, transistors V2418 and V2426 switch off and V2419 and V2424 now conduct so that the signal path is inverted.

After this stage, an offset stage, adjustable from the front panel, adapts the current so that an offset adjustment of four times the voltage range is possible (OFFSET A - V2456; OFFSET B - V2414).

To obtain the facility for switching both A and B channels to zero, necessary in the P<sup>2</sup>CCD mode (see Section 6.2.8.3), both current flows are switched to the supply voltage via transistors V2469 and V2473. To control the zero switching, the Acquisition Control Logic and the time-base system generate the signals NUL IN and P respectively. These signals are applied to a NAND gate, the output of which is fed to operational amplifier 02422 (pins 8, 9 and 10). A zero on the negative input results in a high level on the output and the transistors conduct, thus interrupting the signal current flow.

### 6.2.21.4. Channel switch and mode switch

The principle of this oscilloscope is such that the channel A and channel B signal is always stored in the chopped mode. The CHOP signal, which is derived from the acquisition control logic (A9), is applied to the channel switch via NAND gates (D2428, D2429 on the logic circuit) to determine the positions of the ON/OFF switches. The signals derived from the control gates are called A ON and B ON, these signals being applied via V2468 (V2428) to pins 9 and 11 of D2412 (D2404). If the signal ON is high, the transistor blocks, and via V2474 (V2433), the outer transistors on the right-hand side of D2412 (D2404) become conductive. If the signal ON is low, V2468 (V2428) is conductive and the inner right transistors become conductive, the signal current flow of Y+ and Y- is shunted via pins 13 and 15 of D2412 (D2404), so the channel is switched off.

The following switching modes are indicated in the figures:

- Channel A ON: similar to channel A P<sup>2</sup>CCD mode
  - Channel B ON: similar to channel B P<sup>2</sup>CCD mode
  - Channel A and B ON in ADD mode
  - Dual channel P<sup>2</sup>CCD mode (chopping is effected in P<sup>2</sup>CCD)
- } except for switching in D2409

In all modes except P<sup>2</sup>CCD, chopping is effected by the channel switch.

To obtain a constant load for the supply voltages of the channel switch, it is necessary that the current remains the same, irrespective of the mode selected. Hence the reason for the alternative transistor loads. The relevant current paths are shown in the figures.







Integrated circuit **D2409** serves to switch the signal either to the P<sup>2</sup>CCD amplifier or to the delay line. If the signal **P** is high, the transistor **V2449** blocks and **V2444** becomes conductive. Consequently, the two outer right transistors of **D2409** conduct and the signal is fed to the P AMP OUT 1 and P AMP OUT 2. If the signal **P** is low, the two inner right transistors conduct and the signal is fed to the delay line. This occurs in the direct, roll and sampling mode.

**6.2.21.5. Delay line compensation/Track and Hold Gate**

A symmetrical delay line is mounted between the channel switch (via **D2409**) and a series feedback push-pull amplifier in combination with a shunt feedback push-pull amplifier. The delay line is a symmetrically-mounted spiralled cable with characteristic impedance of **150 Ω** and a delay of approximately **60 ns**. The output is terminated by two series resistors, each of **75 Ω**.

The emitter impedance of the series feedback stage (**D3004**) consists of RC frequency compensation networks.

For greater accuracy, it is preferable to measure the difference between an instantaneous analog signal sample and the previous signal sample rather than measuring each signal value separately. This is done by recovering the previous sample that has been digitised, using a digital-to-analog converter and subtracting this value from the existing value to obtain the analog difference  $\delta V$ .

Transistors **V3004** and **V3003** are used to subtract the previous sample from the existing one. The sample to be subtracted, reconverted from the digital section, is called the DAC **M-1**. This voltage is converted into current and is applied to the emitter of the series feedback stage, **D3004**. As this signal is in antiphase it will be subtracted.

Because of the asymmetrical input to the Track and Hold (T & H) gate, the common-mode signal in addition to the supply voltage variation must be suppressed. For these reasons, the transistors **V3001** and **V3002** are introduced. The emitters are driven by a constant current supply derived from the current source built up by an operational amplifier **D3006** (pins 1, 2 and 3), which measures the voltage across resistor **R3058** and drives **V3008** to maintain constant current. The constant current drives transistors **V3001**, **V3002** in such a way that the bias current is always constant.

The Track and Hold gate will now take a sample controlled by the signal T AND H. This signal is generated on the Trigger Unit A22. If the signal is low, the input signal is tracked. If the signal is high, the instantaneous value of the input signal is held momentarily. This gate is incapable of holding the sample long enough, without voltage droop, to convert it into a digital value. For this reason, a Sample and Hold gate is added on the Conversion Unit A8. The output signal of the Track and Hold gate is applied via a buffer amplifier to **D3003**, an operational amplifier (x5 gain approx.), which compensates the offset voltage. The output of the offset compensation circuit is applied via a multiplexer on the CCD logic unit **A10** to the Sample and Hold gate on the Conversion Unit A8.

**6.2.21.6. Logic circuits (control interfaces)**

In order to activate the correct combination of reed relays, the microprocessor scans the following switches of both channel A and channel B:

AC/DC; 0 and AMPL/DIV switches.

To read the positions of the switches, an eight-input-four-output multiplexer (**D2418**) is addressed, each main loop by **IO0** together with read pulse **RD**.

Address line **A0** ensures that **D2418** is addressed by address **801E** for channel A switching and **801F** for channel B switching.

The output of multiplexer **D2418** and **D2419** is connected to the data-bus lines **D0** .. **D7** and read by the microprocessor system.

The switch settings are converted by the microprocessor system and are applied, via the data-bus, to the latches **D2424**. These outputs ports are enabled by the combination of the write pulse **WR**; the input/output pulse **IO0**, and for each port an address line (**A1** and **A2**) Address **D2424** is **8003**. Address **D2426** is **8005**; address **D2427** is **8006**.

The outputs of these ports are fed to the reed relays; the following table indicates the reed relays that are active in relationship to the position of the switches:

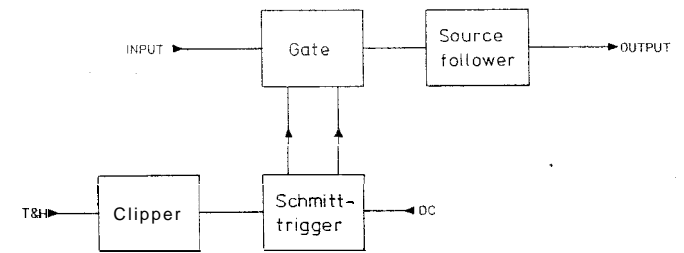
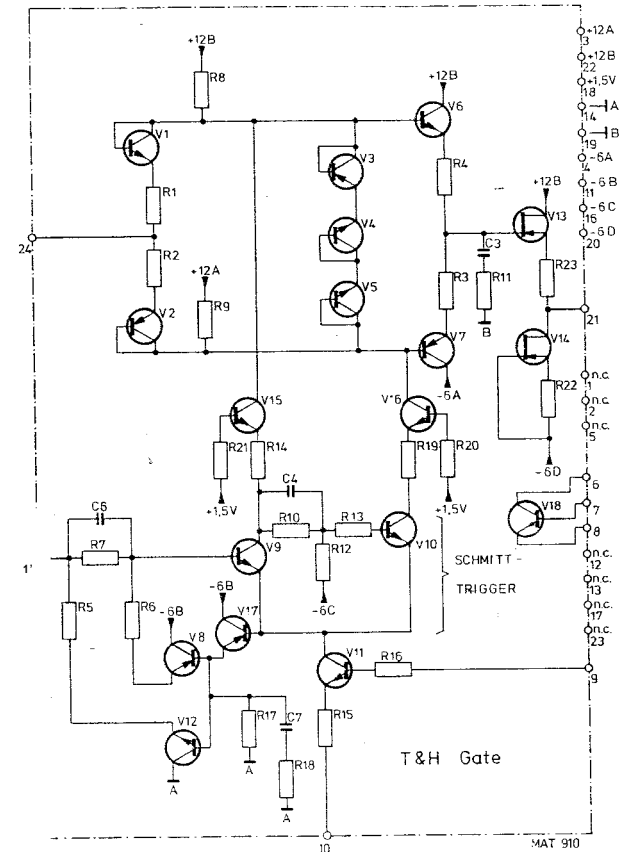
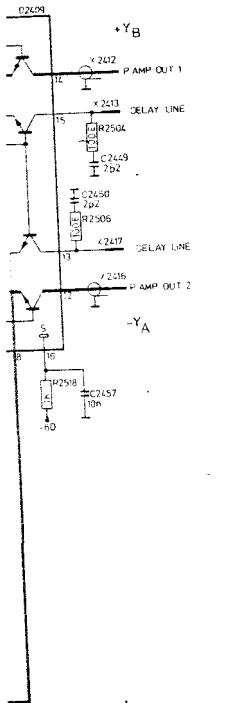

MAT 911

RANGE (x10 probe)	RANGE (x1 probe)	K2412	K2413	K2414	K2416	K2418	K2409	K2411
.1 V	10mV	I/O	1	1	0	0	0	0
.2 V	20mV	I/O	1	1	0	0	0	0
.5 V	50mV	I/O	1	1	0	0	0	0
1 V	.1 V	I/O	1	1	0	0	0	0
2 V	.2 V	I/O	1	1	0	0	0	0
5 v	.5 v	I/O	1	1	0	0	0	0
10 V	1 V	I/O	0	0	1	1	0	0
20 V	2 v	I/O	0	0	1	1	0	0
50 V	5 v	I/O	0	0	1	1	0	0
.1 kV	10 V	I/O	0	0	0	0	1	1
.2 kV	20 V	I/O	0	0	0	0	1	1
.5 kV	50 V	I/O	0	0	0	0	1	1
0	0	I/O	0	0	0	0	0	1

The complete output of D2424 (and D2426) with the corresponding attenuator, AC/DC and 0 switch positions is given in the table below (D2426 is for channel B and is analog):

RANGE (x10 probe)	RANGE (x1 probe)	x10A D6	x1/5A D5	x1/2A D4	x1/1A D4	x1/100A*	x1/100A D3	x1/10A D2	x1A D1	A-DC DO
1 V	10mV	1	1	0	1	1	1	1	0	-
2 V	20mV	1	1	1	0	1	1	1	0	-
5 V	50mV	1	0	0	0	1	1	1	0	-
7 v	1 V	0	1	0	1	1	1	1	0	-
2 v	2 v	0	1	1	0	1	1	1	0	-
5 v	5 v	0	0	0	0	1	1	1	0	-
10 V	1 V	0	1	0	1	1	1	0	1	-
20 V	2 V	0	1	1	0	1	1	0	1	-
50 V	5 v	0	0	0	0	1	1	0	1	-
1 kV	10 V	0	1	0	1	0	0	1	1	-
2 kV	20 v	0	1	1	0	0	0	1	1	-
5 kV	50 V	0	0	0	0	0	0	1	1	-
0	0	0/1	0/1	0/1	0/1	0	1	1	1	0
AC	AC	-	-	-	-	-	-	-	-	-
DC	DC	-	-	-	-	-	-	-	-	-

Range indication

When using a probe with range indication, the microprocessor system calculates the attenuation of the probe, which is then displayed on the scale rings of the AMPL/DIV switches and also in the alphanumeric display. The microprocessor system obtains the information of the probe, via D2417, by the signals PA0, PA1, PB0, PB1 for channels A and B respectively. These signals are decoded in the microprocessor system and then applied to the displays.

INCOMING SIGNAL	OUTGOING SIGNAL	GENERATED ON UNIT	USED ON UNIT	DESCRIPTION
A0-1-2		A4		Address bits from system address bus
ACON		A202		Slider of channel A continuous control
BCON		A202		Slider of channel B continuous control
CHOP		A9		Chopper signal
00.., D7		A4		Data-bits from system data bus
	D0..D7	A21	A4	Data bits to system data bus
DAC M-1		A7		DAC M-1 output signal
	DRS	A21	A10	Signal information in D-R and S mode
ERUN		A22		Enable run signal
100		A4		I/O address decoding signal
NULIN		A9		Signal to switch vert. ampl. input to zero
OFFA		A202		Slider of channel A OFFSET control
OFFE		A202		Slider of channel B OFFSET control
P		A12		P mode signal
	PAMP0UT1	A21	A11	Output signal for P2CCD
	PAMP0UT2	A21	A11	Output signal for P2CCD
RD		A4		Signal READ from microprocessor
RECURR		A22		Signal from RECURR switch
ROLL		A22		Signal from ROLL switch
RUN		A22		Signal from R/S-RESET switch
SINGLE		A22		Signal from SINGLE switch
TANDH		A22		Track and hold signal
WR		A4		Signal WRITE from microprocessor
+6 V		A15		
-6 V		A15		
+12 V		A15		
-12 V		A15		
		A15		

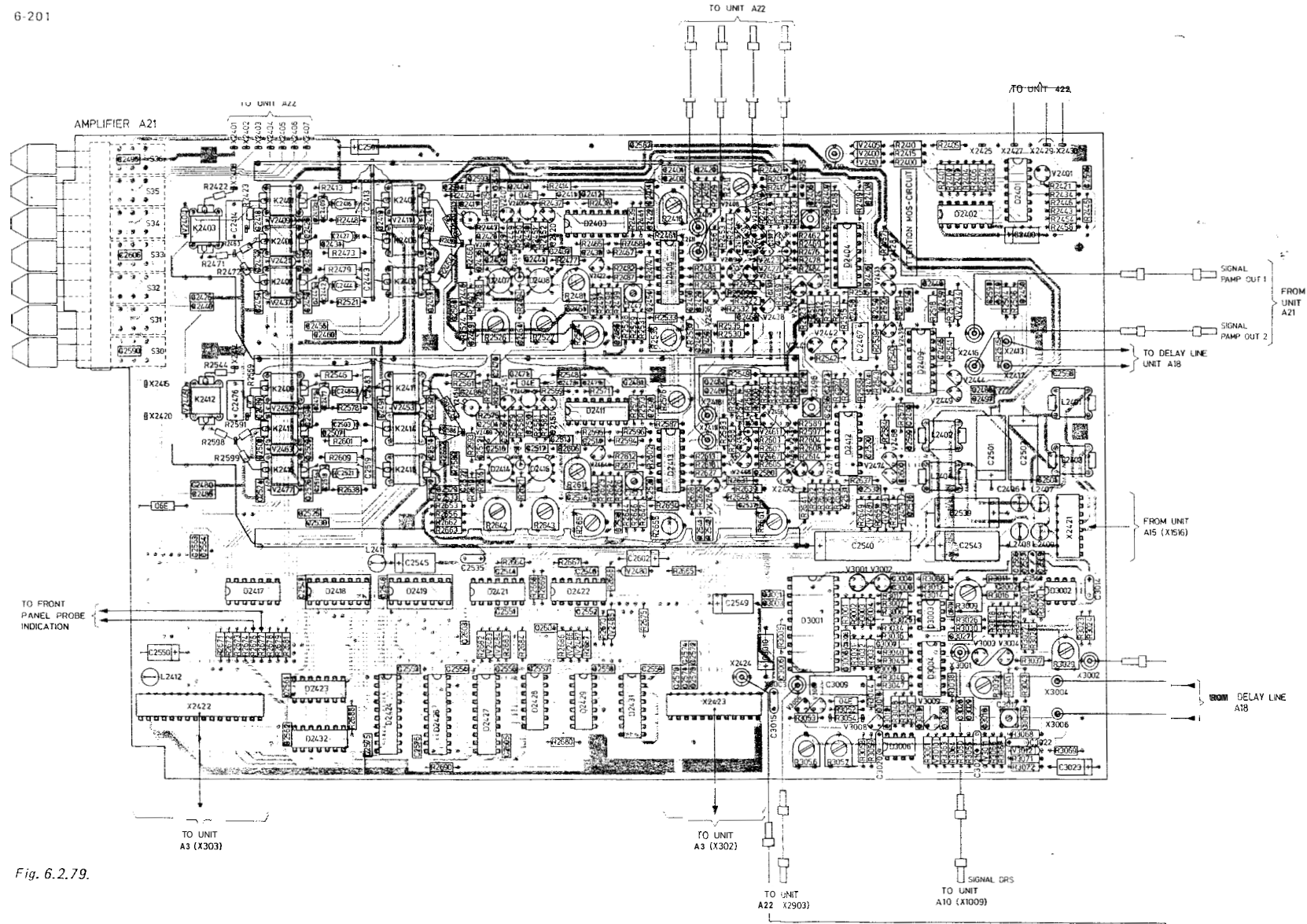

Fig. 6.2.79.

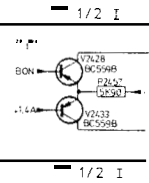
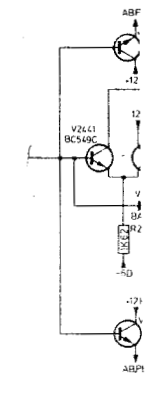
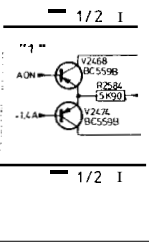
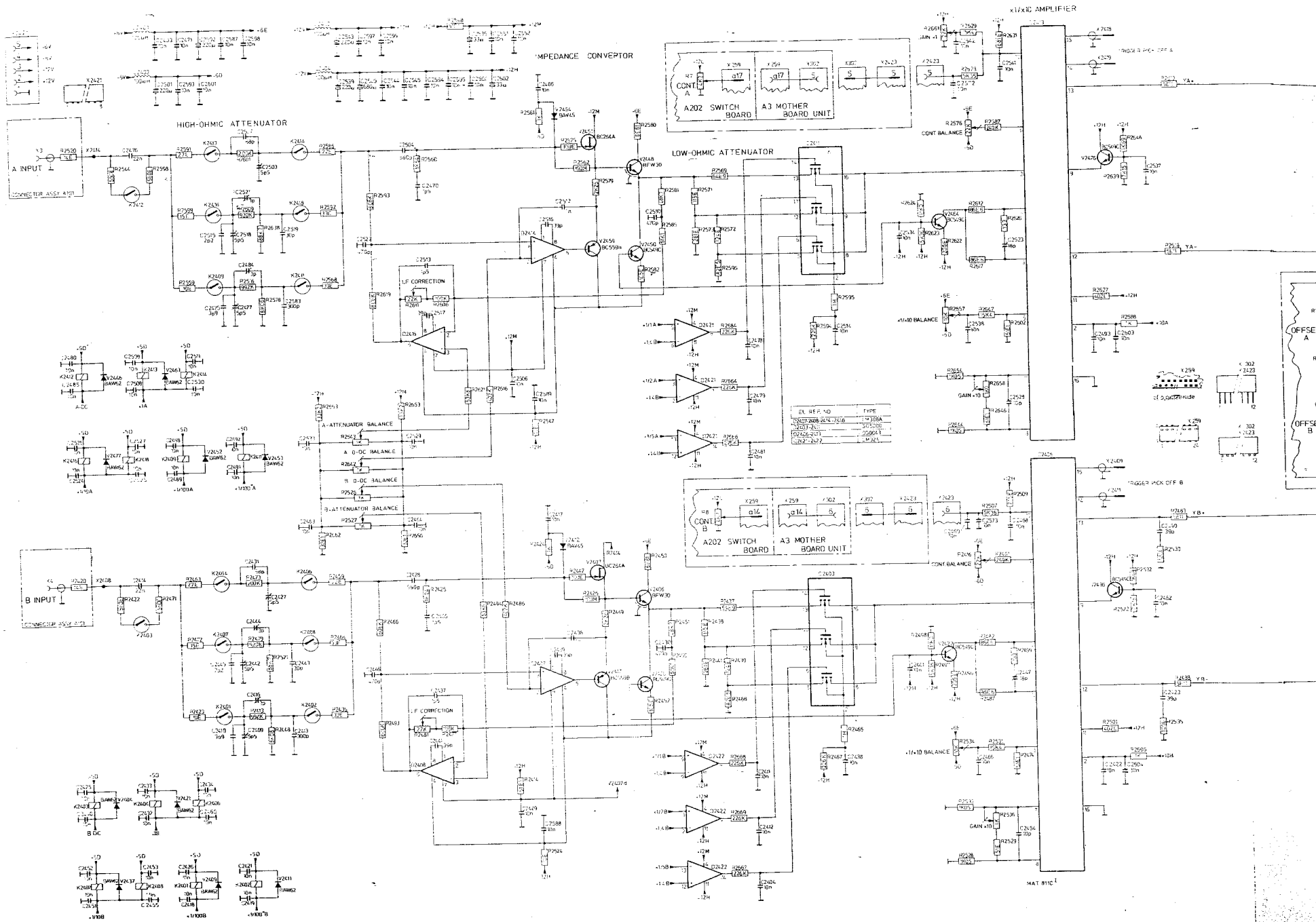
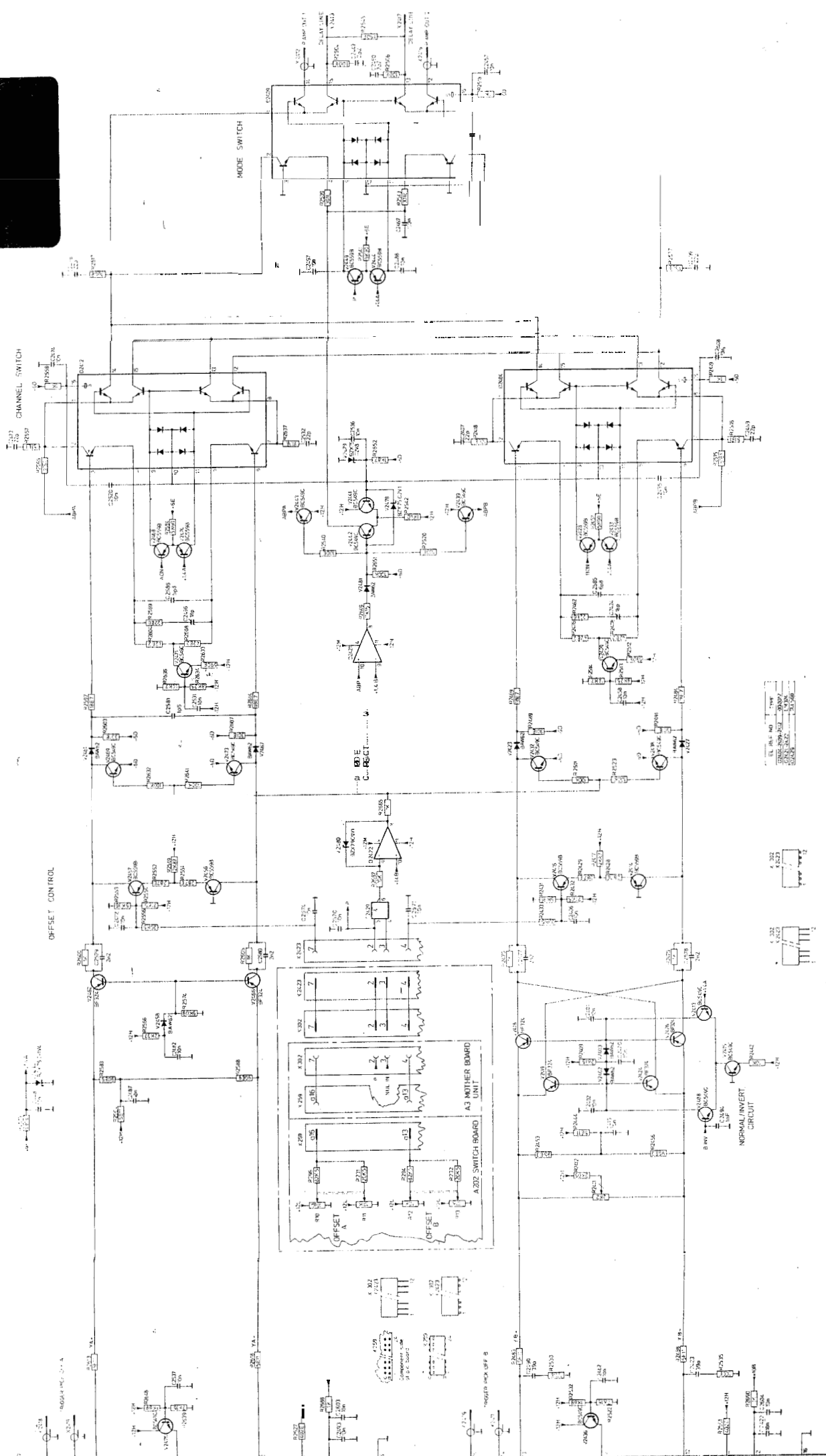

Fig. 6.2.77



PM3311



MT

Part No.	Value	Notes
6X10	6X10	
6X11	6X11	
6X12	6X12	
6X13	6X13	
6X14	6X14	
6X15	6X15	
6X16	6X16	
6X17	6X17	
6X18	6X18	
6X19	6X19	
6X20	6X20	
6X21	6X21	
6X22	6X22	
6X23	6X23	
6X24	6X24	
6X25	6X25	
6X26	6X26	
6X27	6X27	
6X28	6X28	
6X29	6X29	
6X30	6X30	
6X31	6X31	
6X32	6X32	
6X33	6X33	
6X34	6X34	
6X35	6X35	
6X36	6X36	
6X37	6X37	
6X38	6X38	
6X39	6X39	
6X40	6X40	
6X41	6X41	
6X42	6X42	
6X43	6X43	
6X44	6X44	
6X45	6X45	
6X46	6X46	
6X47	6X47	
6X48	6X48	
6X49	6X49	
6X50	6X50	
6X51	6X51	
6X52	6X52	
6X53	6X53	
6X54	6X54	
6X55	6X55	
6X56	6X56	
6X57	6X57	
6X58	6X58	
6X59	6X59	
6X60	6X60	
6X61	6X61	
6X62	6X62	
6X63	6X63	
6X64	6X64	
6X65	6X65	
6X66	6X66	
6X67	6X67	
6X68	6X68	
6X69	6X69	
6X70	6X70	
6X71	6X71	
6X72	6X72	
6X73	6X73	
6X74	6X74	
6X75	6X75	
6X76	6X76	
6X77	6X77	
6X78	6X78	
6X79	6X79	
6X80	6X80	
6X81	6X81	
6X82	6X82	
6X83	6X83	
6X84	6X84	
6X85	6X85	
6X86	6X86	
6X87	6X87	
6X88	6X88	
6X89	6X89	
6X90	6X90	
6X91	6X91	
6X92	6X92	
6X93	6X93	
6X94	6X94	
6X95	6X95	
6X96	6X96	
6X97	6X97	
6X98	6X98	
6X99	6X99	
6X100	6X100	

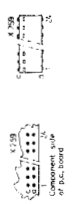

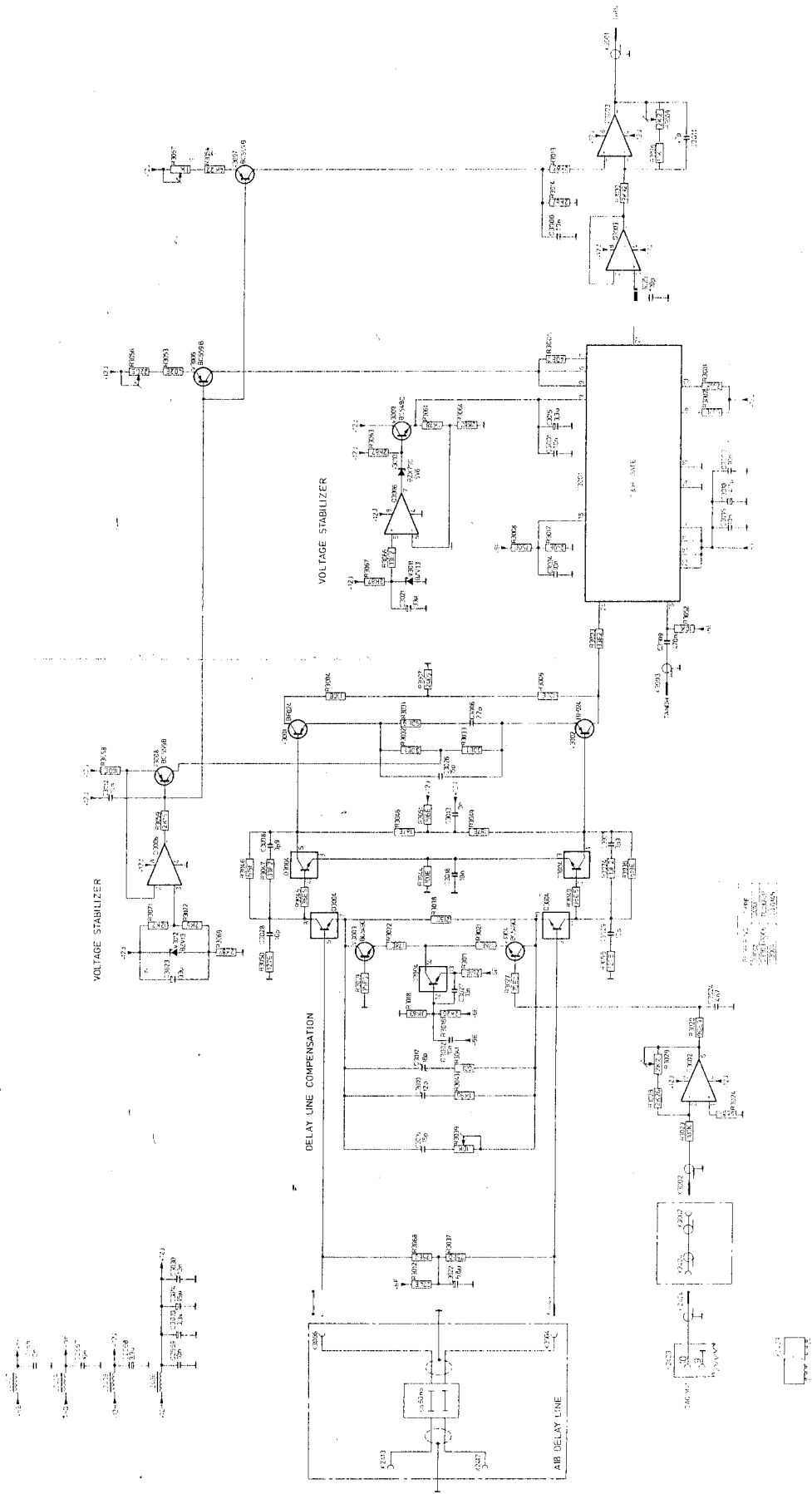

1. 2. 3. 4. 5. 6. 7. 8. 9. 10. 11. 12. 13. 14. 15. 16. 17. 18. 19. 20. 21. 22. 23. 24. 25. 26. 27. 28. 29. 30. 31. 32. 33. 34. 35. 36. 37. 38. 39. 40. 41. 42. 43. 44. 45. 46. 47. 48. 49. 50. 51. 52. 53. 54. 55. 56. 57. 58. 59. 60. 61. 62. 63. 64. 65. 66. 67. 68. 69. 70. 71. 72. 73. 74. 75. 76. 77. 78. 79. 80. 81. 82. 83. 84. 85. 86. 87. 88. 89. 90. 91. 92. 93. 94. 95. 96. 97. 98. 99. 100.

NAT PRO

Fig. 6.2.81.



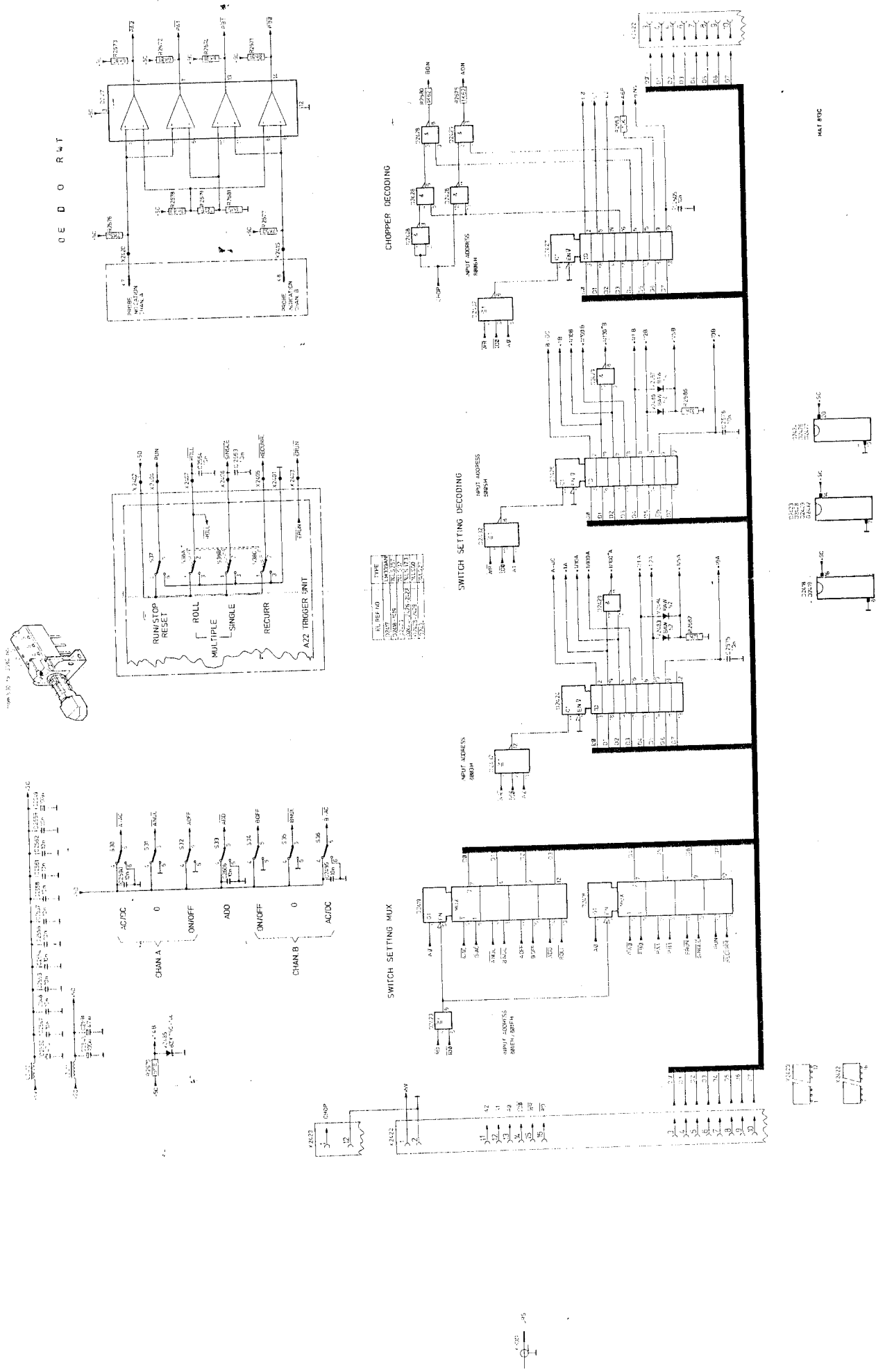

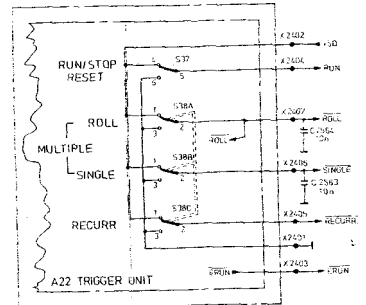
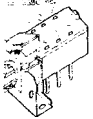

| EL. REF. NO. | TYPE    |
|--------------|---------|
| 1            | LM139AN |
| 2            | 74LS00  |
| 3            | 74LS00  |
| 4            | 74LS00  |
| 5            | 74LS00  |
| 6            | 74LS00  |
| 7            | 74LS00  |
| 8            | 74LS00  |
| 9            | 74LS00  |
| 10           | 74LS00  |
| 11           | 74LS00  |
| 12           | 74LS00  |
| 13           | 74LS00  |
| 14           | 74LS00  |
| 15           | 74LS00  |
| 16           | 74LS00  |
| 17           | 74LS00  |
| 18           | 74LS00  |
| 19           | 74LS00  |
| 20           | 74LS00  |
| 21           | 74LS00  |
| 22           | 74LS00  |
| 23           | 74LS00  |
| 24           | 74LS00  |
| 25           | 74LS00  |
| 26           | 74LS00  |
| 27           | 74LS00  |
| 28           | 74LS00  |
| 29           | 74LS00  |
| 30           | 74LS00  |
| 31           | 74LS00  |
| 32           | 74LS00  |
| 33           | 74LS00  |
| 34           | 74LS00  |
| 35           | 74LS00  |
| 36           | 74LS00  |
| 37           | 74LS00  |
| 38           | 74LS00  |
| 39           | 74LS00  |
| 40           | 74LS00  |
| 41           | 74LS00  |
| 42           | 74LS00  |
| 43           | 74LS00  |
| 44           | 74LS00  |
| 45           | 74LS00  |
| 46           | 74LS00  |
| 47           | 74LS00  |
| 48           | 74LS00  |
| 49           | 74LS00  |
| 50           | 74LS00  |
| 51           | 74LS00  |
| 52           | 74LS00  |
| 53           | 74LS00  |
| 54           | 74LS00  |
| 55           | 74LS00  |
| 56           | 74LS00  |
| 57           | 74LS00  |
| 58           | 74LS00  |
| 59           | 74LS00  |
| 60           | 74LS00  |
| 61           | 74LS00  |
| 62           | 74LS00  |
| 63           | 74LS00  |
| 64           | 74LS00  |
| 65           | 74LS00  |
| 66           | 74LS00  |
| 67           | 74LS00  |
| 68           | 74LS00  |
| 69           | 74LS00  |
| 70           | 74LS00  |
| 71           | 74LS00  |
| 72           | 74LS00  |
| 73           | 74LS00  |
| 74           | 74LS00  |
| 75           | 74LS00  |
| 76           | 74LS00  |
| 77           | 74LS00  |
| 78           | 74LS00  |
| 79           | 74LS00  |
| 80           | 74LS00  |
| 81           | 74LS00  |
| 82           | 74LS00  |
| 83           | 74LS00  |
| 84           | 74LS00  |
| 85           | 74LS00  |
| 86           | 74LS00  |
| 87           | 74LS00  |
| 88           | 74LS00  |
| 89           | 74LS00  |
| 90           | 74LS00  |
| 91           | 74LS00  |
| 92           | 74LS00  |
| 93           | 74LS00  |
| 94           | 74LS00  |
| 95           | 74LS00  |
| 96           | 74LS00  |
| 97           | 74LS00  |
| 98           | 74LS00  |
| 99           | 74LS00  |
| 100          | 74LS00  |

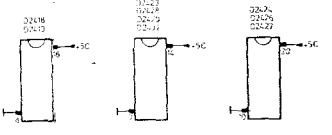
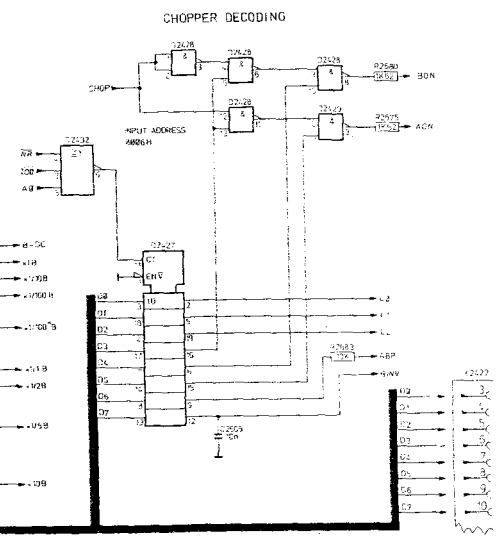
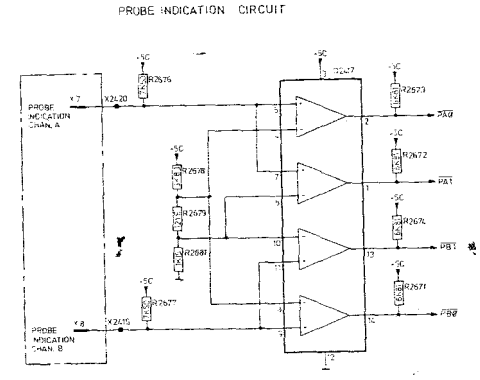

MAT 131C

6.2.22. Trigger unit A22

The trigger unit comprises the following circuits:

- Trigger source switching circuit
- AC-DC coupling
- Peak-peak detector
- Level circuit
- Slope circuit
- TV circuit
- Pulse stretcher
- Time-base slow circuit
- Sampling circuit

6.2.22.1. Trigger source switching circuit

The trigger source switching circuit serves to detect the selected trigger source, the various possibilities being:

- channel A
- channel B
- LINE
- EXTERN
- EXTERN ÷ 10

With no pushbutton depressed, channel A is automatically chosen. Transistor V2723 provides this facility. If all pushbuttons are released, the base of V2723 is connected to zero, which causes the transistor to block. In turn, transistors V2746 and V2747 are blocked and therefore the signal of channel A is enabled. In all other positions of the switches, except for CHAN A switch, V2723 is conductive and the channel A signal flows via V2746 and V2747 to the -6 V supply line, i.e. it is blocked.

In single or recurrent operation, two modes of external triggering are possible: EXT and EXT ÷ 10. In the EXT ÷ 10 mode, the input signal is attenuated by a factor of 10 and applied to the amplifier. The h.f. path of the amplifier is via C2708 and V2701 to V2702; the i.f. path is a.c.-coupled via C2719 and D2708 to V2702, and d.c.-coupled via D2709 (13, 14) and D2708 to V2702.

In the roll-mode the function of the external input is a RUN/STOP action at TTL-level. This is a software OR-function together with the position of the R/S switch. A high level at the input is applied to V2727 via 02709 and D2708, V2702, V2707. This causes the ERUN signal to go high, which then starts the ROLL-mode via the software program if the R/S switch is at STOP.

6.2.22.2. AC-DC coupling

The trigger signal is routed to V2724 and V2729 via the AC-DC coupling circuit. If the d.c. signal is high, the reed relay K2701 switches off and the signal is applied to the bases of V2724 and V2729 via R2789, R2788 and R2792, R2791 respectively. If the d.c. signal is low, the reed relay is energised and the d.c. component in the trigger signal is filtered out, the a.c. component flowing through C2737 and C2743. The signal is applied via an amplifier stage to the input of the slope circuit and the input of the peak-peak detector.

6.2.22.3. Peak-peak detector

A peak-to-peak detector is introduced to enable the possibility of levelling between the positive and negative peaks of the signal in the AUTO mode. The positive peak flows via the base-emitter diode of D2703 (6, 7, 8), to charge electrolytic capacitor C2709. The current required to drive D2703 (9, 10, 11) is obtained from D2704 (5, 6, 7). The output of this amplifier is the d.c. level proportional to the positive peak. The negative peak flows via the emitter-collector diode of D2703 (1, 2, 3) to charge C2711. This peak voltage is amplified by D2704 (1, 2, 3) to give an output d.c. level proportional to the negative peak.

6.2.22.4. Level circuit

The level potentiometer is connected to the outputs of a multiplexer D2701. Depending on the signals TV and OH, the level potentiometer is connected to:

Fig. 6.2.82

| MODE     | D2701 OUTPUTS |        | TV | OH |
|----------|---------------|--------|----|----|
|          | 13            | 3      |    |    |
| AUTO     | postop        | negtop | 0  | 0  |
| DC or AC | d.c.          | d.c.   | 0  | 1  |
| TV +     | postop        | postop | 1  | 0  |
| TV -     | negtop        | negtop | 1  | 1  |

**6.2.22.5. Slope circuit**

The trigger signal is applied to the differential amplifier in D2711. The output of the level circuit is applied to the other input. Depending on the position of the slope switch, either V2732 or V2751 conducts, which causes the positive or negative signal to be connected to the outputs of D2711. The trigger signal is applied via an electronic switch V2761 and its associated components to ECL-Schmitt trigger D2907 (2, 3, 4, 5).

**6.2.22.6. TV circuit**

The outputs 12 and 13 of D2711 are applied to the video clipper consisting of V2717 and its components. The TV trigger signal is now applied to two re-triggerable monostable one-shots (D2702) in series, with different pulse times. The output of the first one-shot is applied to the clock input of D-flip-flop D2707. This flip-flop is enabled by the TV signal. At output 9 of D2707 a 50 Hz field pulse is available. To obtain frame pulses, the inverting output 8 of D2707 is applied to clock input 3. At the D input 2, the output of the second one-shot is applied. The frame pulse now appears at the inverting output 5 of D2707. Normal triggering is now inhibited because of the TV signal applied to the electronic switch V2761, which causes the voltage at X2708 to go low.

**6.2.22.7. Pulse stretcher**

The trigger pulse is applied via the ECL-Schmitt trigger to the clock input of the dual ECL D-flip-flop D2904. This flip-flop in combination with two Schmitt trigger circuits D2907 (9, 10, 6, 7), D2907 (12, 13, 14, 15) form the pulse stretcher. The principle is shown in the following diagram.

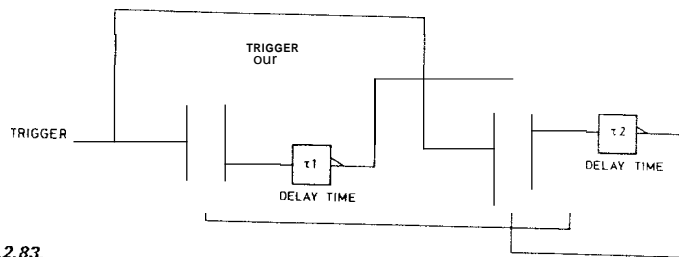

Fig. 6.2.83.

On receipt of a trigger pulse at the clock input of FFI, its inverted output goes low. After time  $t_1$ , this output is applied as a logic high signal, which sets FFII. Consequently, its inverted output goes low and the non-inverting output goes high. This results in a reset of FFI. After  $t_2$ , FFI is reset and, as a result, FFI is enabled.

Times  $t_1$  and  $t_2$  are chosen so that the pulse stretcher acts as a pulse-shaper at frequencies up to 2kHz, as a divide-by-two circuit from 2kHz to 10kHz, and as a divider by  $n$  for frequencies above 10kHz.

**6.2.22.8. Time-base slow circuit**

The output of the pulse stretcher is converted to TTL-level by the two converters D2906. The upper converter produces the TRIST signal which is applied to the delayed trigger unit A13. In the sampling mode, the lower converter can feed the trigger signal to the sampling system.

In the Direct and Roll-modes, the system is operated by the TBS signal. This signal is fed via Inverter D2911 (5; 6) and NAND-gate D2912 (11, 12, 13) to the clock input 11 of D-flip-flop D2909. At the inverted output 8, a low level is clocked, which is the STOP signal. This STOP signal is applied to multiplexer 02908 and via the inverted output and diode V2919 to the wired-OR gate (D2911-13). Pin 12 of D2911 goes low and via the upper NAND-gate of D2902 a Track and Hold (TANDH) pulse is generated.

The lower NAND-gate of D2902 is controlled by the TANDH pulse via D2903 (13, 11) and inverter 02911 at 11, Z1 and generates a HONCONDRS pulse. At the same moment, a TANDH pulse is taken over by a high level at output 8 of D2903.

The HONCONDRS pulse goes high after 3.6  $\mu$ s caused by the RC combination R2928 and C2918, C2919. After approximately 0.4  $\mu$ s, output 8 of D2903 goes low and therefore the HONCONDRS pulse again becomes low.

**6.2.22.9. The sampling circuit**

If the oscilloscope is in the sampling mode, the output of the pulse stretcher is applied to the clock input 11 of D2909. This flip-flop is enabled by a high level on reset input 13, and its inverted output blocks transistors V2916 and V2913.

Sawtooth capacitor C2923 starts charging with a current derived from the current source V2922. The current that feeds the fast ramp sawtooth generator is determined by the settings of the time-base switch. These settings are decoded by the microprocessor system and applied to a FET-switch array D2401 and FET V2401, via D2402. The following table shows the relationship between the time-base settings and the current-source control FETs.

|                | D2431 |   |    |   |   | D2431 |    |    |
|----------------|-------|---|----|---|---|-------|----|----|
|                | 4     | 5 | 11 | 6 | 7 | L2    | L1 | L0 |
| 5 ns/div       | 1     | 1 | 0  | 1 | 1 | 1     | 1  | 0  |
| 10ns/div       | 1     | 0 | 1  | 1 | 1 | 0     | 0  | 1  |
| 20ns/div       | 1     | 1 | 1  | 0 | 1 | 1     | 0  | 0  |
| 50ns/div       | 1     | 1 | 1  | 1 | 0 | 1     | 0  | 1  |
| .1 $\mu$ s/div | 0     | 1 | 1  | 1 | 1 | 0     | 0  | 0  |

One control line is always low. This means that one of the resistors R2421, R2443, R2446, R2454 and R2458 is switched in parallel with the current-determining resistor R2434. The value of the resistors is determined so that in the 5ns/cm position the highest current is obtained.

The fast ramp sawtooth voltage is applied to the positive input of comparator D2902 (11, 12). To the negative input, a preset voltage built-up from DACSTAIR and DACDEL is applied. If the last ramp reaches the potential of the preset voltage, the comparator output goes low and the triple-NAND gate goes high for 4  $\mu$ s (described under time-base slow).

The sawtooth voltage is blocked and the capacitor is discharged by a reset pulse derived from the TANDH pulse at D2909-13, so output 8 goes high.

The flip-flop is enabled to start a new sawtooth ramp if the TANDH signal is low and TRACK is high. The DACSTAIR signal is generated at the ACL unit and is divided into 256 steps, each of 40 mV. The DACDEL signal is generated on the delayed time-base unit and is divided into 200 steps, each of 40 mV. This means that each division delay corresponds to two steps (i.e. 80 mV). The resistor network R2910, R2913, R2914 is chosen so that 256 steps of DACSTAIR generate the same potential as 20 steps of OACDEL at input 6 of D2901.

If no sampling mode is chosen, the TANDH signal is not generated by means of the sawtooth generator and the comparator, but via the system described under time-base slow. This is effected by presetting the negative input 11 of the comparator to a high voltage via D2901.

| INCOMING SIGNAL      | OUTGOING SIGNAL | GENERATED ON UNIT | USED ON UNIT | DESCRIPTION   |
|----------------------|-----------------|-------------------|--------------|---|
| DAC DEL<br>DAC STAIR | AUTO TB         | A22<br>A13        | A13          | Auto signal from AUTO switch<br>Output signal of DAC delay    |
|                      | ERUN            | A9<br>A22         | A21          | Output signal of DAC STAIR<br>Enable run signal               |
| FRUN                 | HOCONDRS        | A13<br>A22        | A9           | Freerun signal<br>Hold and convert signal in D-R and S-mode   |
| LINE S               |                 | A15<br>A12        |              | Signal for mains triggering<br>S-mode signal                  |
| TBS TRACK            | TANDH           | A22<br>A12        | A21          | Track and hold signal<br>Time-baseslow                        |
| +5v                  | TRIST           | A9<br>A22         | A13          | Track command for S/H circuit<br>Trigger signal for stretcher |
| -5.2V                |                 | A15               |              |   |
| +6V                  |                 | A15               |              |   |
| -6V                  |                 | A15               |              |   |
| +12V                 |                 | A15               |              |   |
| -12V                 |                 | A15               |              |   |
| +40V                 |                 | A15               |              |   |
|                      |                 | A15               |              |   |

## TEST POINTS

|       |                  |
|-------|------------------|
| X2700 | External trigger |
| X2707 | TRIGGER SIGNAL   |
| X2708 | TRIG.            |
| X2905 | HOCONDRS         |



5-219

6-220

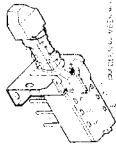

CHANNEL A

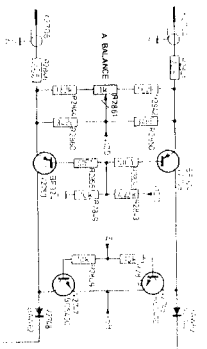

CHANNEL B

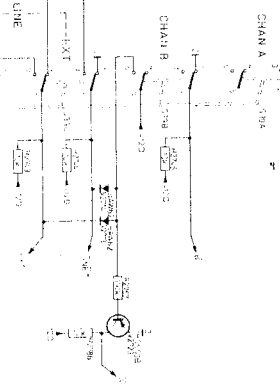
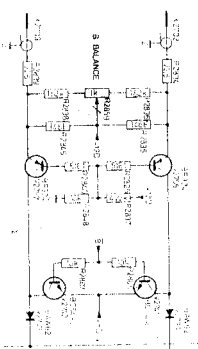

IMPEDANCE CONVERTER

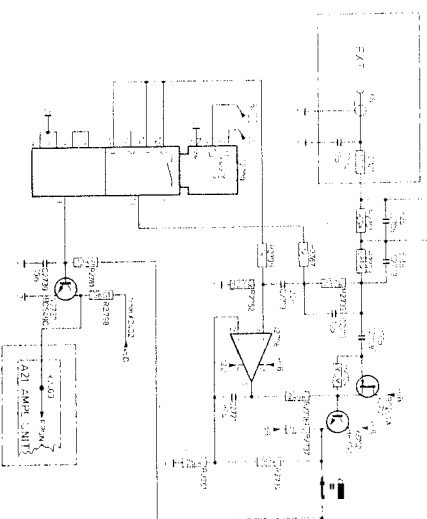

ADJUST SWITCH

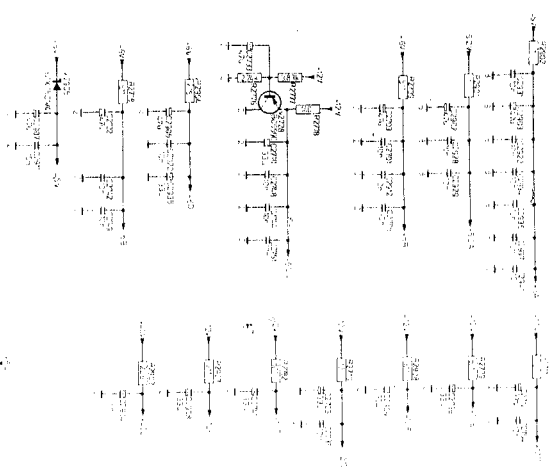
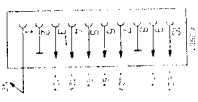
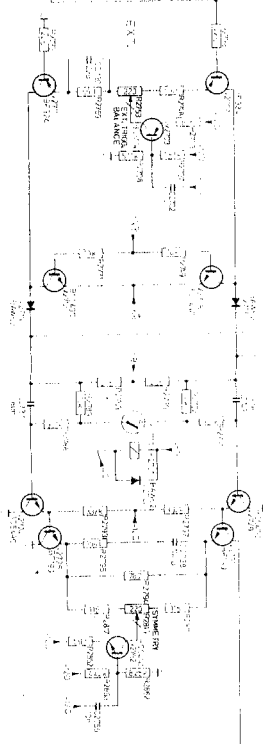

SEPARATE SECTION

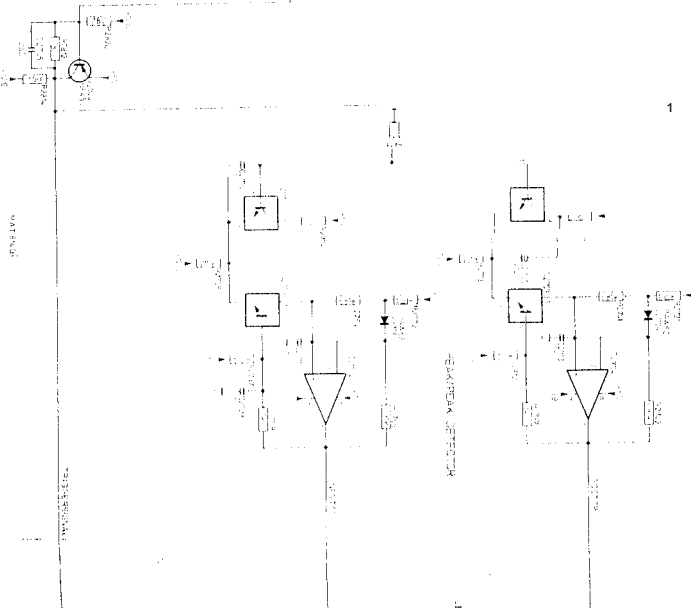

ATTENUATOR

ATTENUATOR

6-221

6-222

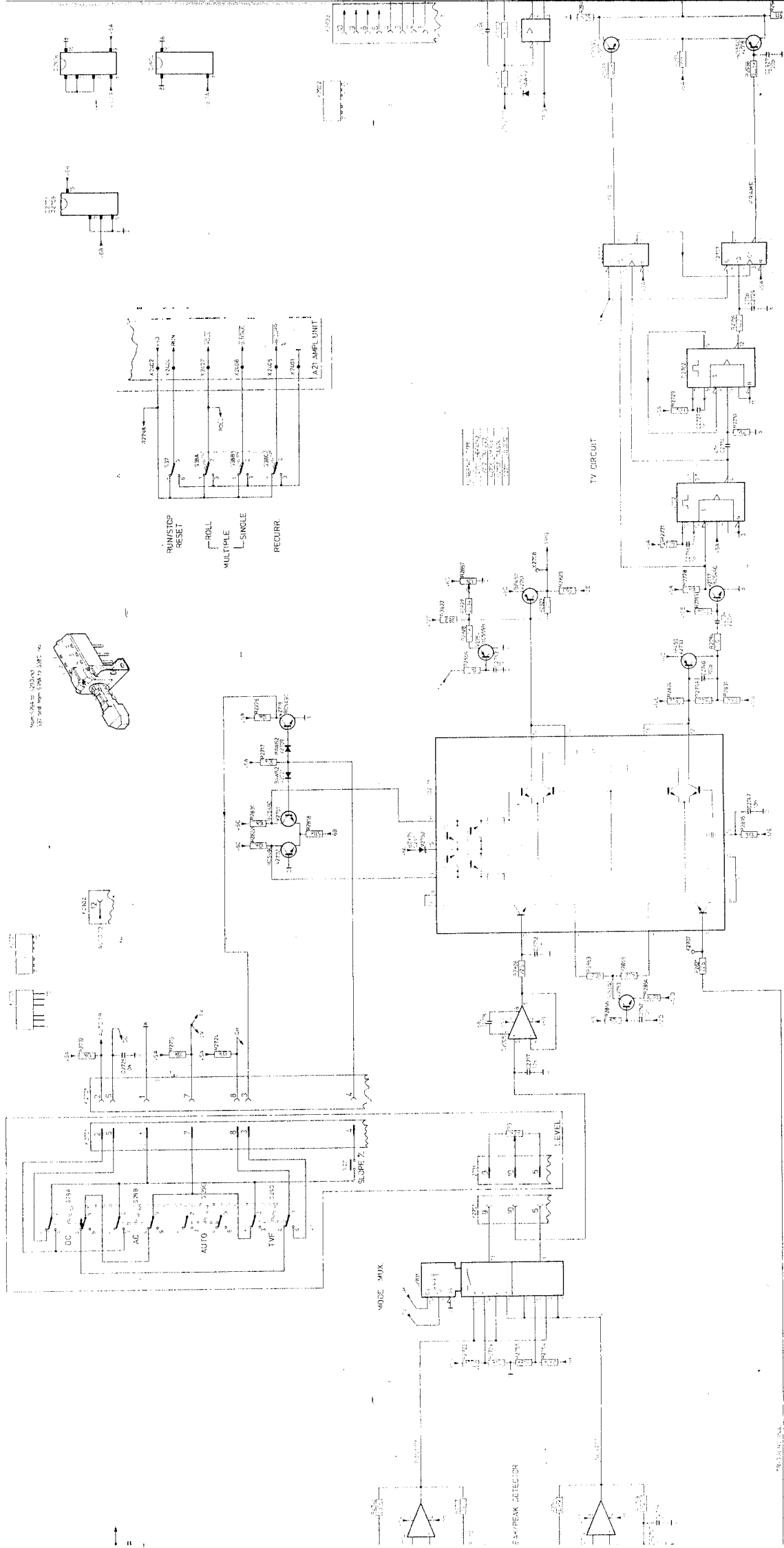

From 50A-12 (200A-1) 157 and from 50A-15 (200A-1) 157

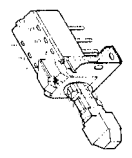

PAUSE/STOP  
 RESET  
 ROLL  
 MULTIPLE  
 SINGLE  
 RECURR.

|    |      |
|----|------|
| 1  | 100K |
| 2  | 100K |
| 3  | 100K |
| 4  | 100K |
| 5  | 100K |
| 6  | 100K |
| 7  | 100K |
| 8  | 100K |
| 9  | 100K |
| 10 | 100K |
| 11 | 100K |
| 12 | 100K |
| 13 | 100K |
| 14 | 100K |
| 15 | 100K |
| 16 | 100K |
| 17 | 100K |
| 18 | 100K |
| 19 | 100K |
| 20 | 100K |
| 21 | 100K |
| 22 | 100K |
| 23 | 100K |
| 24 | 100K |
| 25 | 100K |
| 26 | 100K |
| 27 | 100K |
| 28 | 100K |
| 29 | 100K |
| 30 | 100K |
| 31 | 100K |
| 32 | 100K |
| 33 | 100K |
| 34 | 100K |
| 35 | 100K |
| 36 | 100K |
| 37 | 100K |
| 38 | 100K |
| 39 | 100K |
| 40 | 100K |
| 41 | 100K |
| 42 | 100K |
| 43 | 100K |
| 44 | 100K |
| 45 | 100K |
| 46 | 100K |
| 47 | 100K |
| 48 | 100K |
| 49 | 100K |
| 50 | 100K |

MATRUBET

PM 3311  
6-224

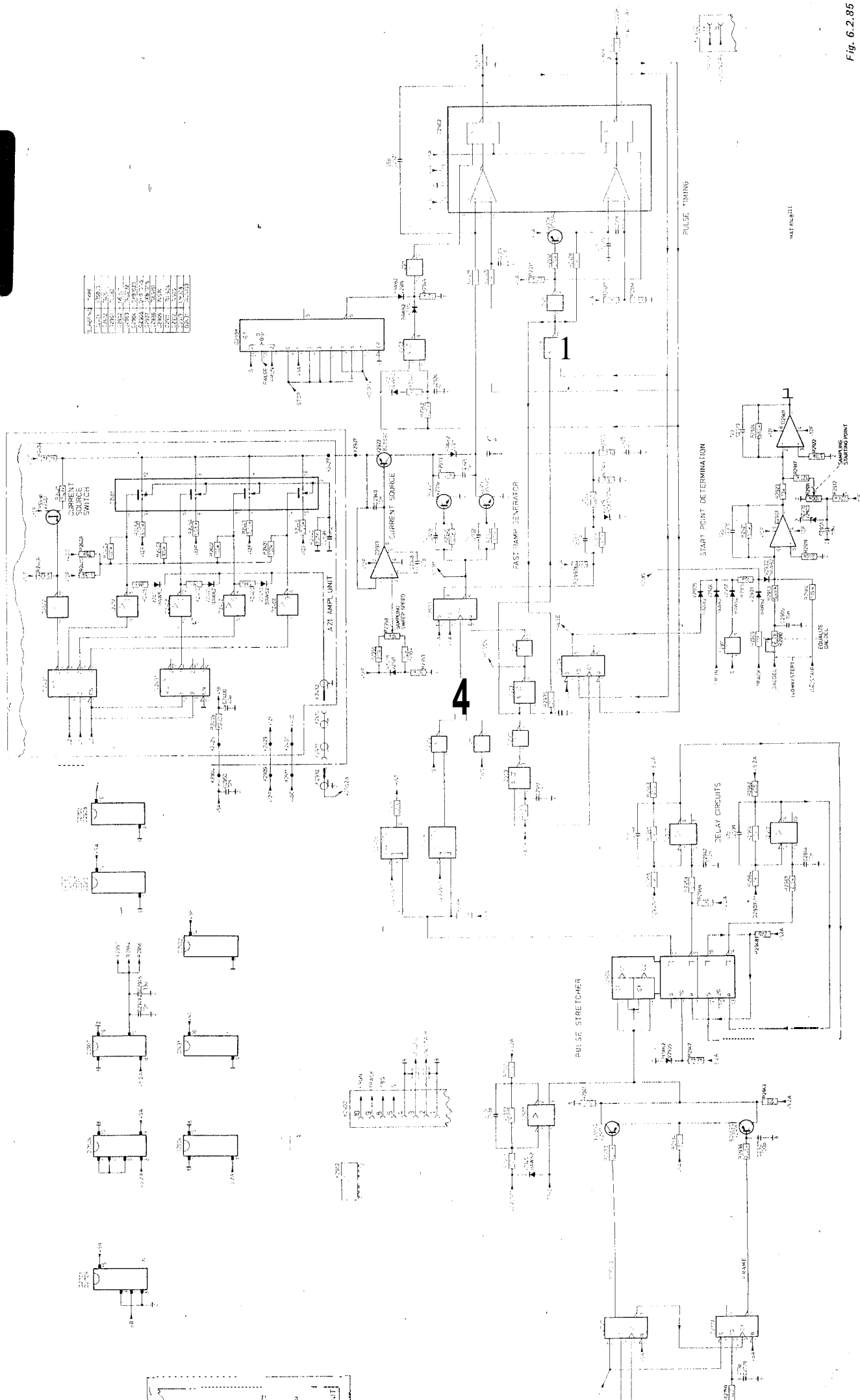

| TYPE | VALUE |
|------|-------|
| R1   | 10K   |
| R2   | 10K   |
| R3   | 10K   |
| R4   | 10K   |
| R5   | 10K   |
| R6   | 10K   |
| R7   | 10K   |
| R8   | 10K   |
| R9   | 10K   |
| R10  | 10K   |
| R11  | 10K   |
| R12  | 10K   |
| R13  | 10K   |
| R14  | 10K   |
| R15  | 10K   |
| R16  | 10K   |
| R17  | 10K   |
| R18  | 10K   |
| R19  | 10K   |
| R20  | 10K   |
| R21  | 10K   |
| R22  | 10K   |
| R23  | 10K   |
| R24  | 10K   |
| R25  | 10K   |
| R26  | 10K   |
| R27  | 10K   |
| R28  | 10K   |
| R29  | 10K   |
| R30  | 10K   |
| R31  | 10K   |
| R32  | 10K   |
| R33  | 10K   |
| R34  | 10K   |
| R35  | 10K   |
| R36  | 10K   |
| R37  | 10K   |
| R38  | 10K   |
| R39  | 10K   |
| R40  | 10K   |
| R41  | 10K   |
| R42  | 10K   |
| R43  | 10K   |
| R44  | 10K   |
| R45  | 10K   |
| R46  | 10K   |
| R47  | 10K   |
| R48  | 10K   |
| R49  | 10K   |
| R50  | 10K   |
| R51  | 10K   |
| R52  | 10K   |
| R53  | 10K   |
| R54  | 10K   |
| R55  | 10K   |
| R56  | 10K   |
| R57  | 10K   |
| R58  | 10K   |
| R59  | 10K   |
| R60  | 10K   |
| R61  | 10K   |
| R62  | 10K   |
| R63  | 10K   |
| R64  | 10K   |
| R65  | 10K   |
| R66  | 10K   |
| R67  | 10K   |
| R68  | 10K   |
| R69  | 10K   |
| R70  | 10K   |
| R71  | 10K   |
| R72  | 10K   |
| R73  | 10K   |
| R74  | 10K   |
| R75  | 10K   |
| R76  | 10K   |
| R77  | 10K   |
| R78  | 10K   |
| R79  | 10K   |
| R80  | 10K   |
| R81  | 10K   |
| R82  | 10K   |
| R83  | 10K   |
| R84  | 10K   |
| R85  | 10K   |
| R86  | 10K   |
| R87  | 10K   |
| R88  | 10K   |
| R89  | 10K   |
| R90  | 10K   |
| R91  | 10K   |
| R92  | 10K   |
| R93  | 10K   |
| R94  | 10K   |
| R95  | 10K   |
| R96  | 10K   |
| R97  | 10K   |
| R98  | 10K   |
| R99  | 10K   |
| R100 | 10K   |

4

6-223

Fig. 6.2.85



6.2.23. EHT unit A23

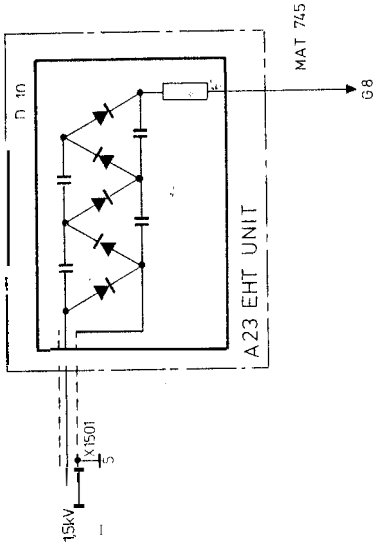

Fig. 6.2.86

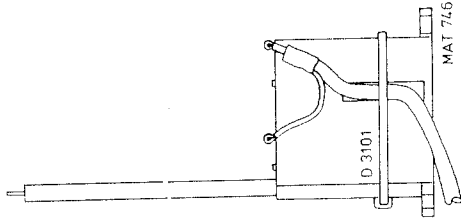

Fig. 6.2.87

6-230

6.2.24. Clock-pulse generator. Driver unit A34.

The four clock-pulse signals P2, A2, P1 and A1 needed to shift the signal samples through the P<sup>2</sup>CCD, are produced by clock-pulse generator D1001 in combination with the LC filters on unit A11, which are terminated by 50 Ω resistors to minimise reflections. One of these double-T filters is connected between the output pins 7 and 6, and the other between the output pins 9 and 10 of clock-pulse generator D1001. The resulting four square-wave clock-pulse signals have a high level of +11.4 V and a low level of +2 V as shown below.

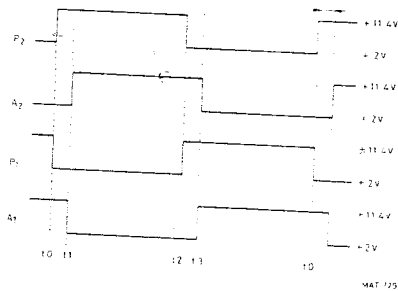

Fig. 6.2.44.

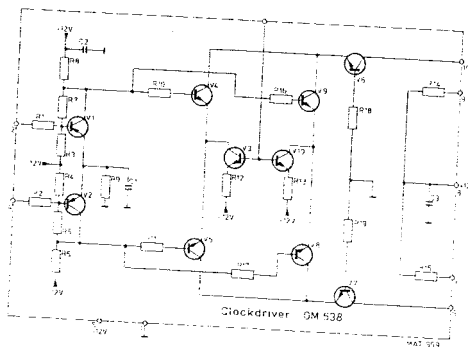

Fig. 6.2.44a

Signals P2/A2 are 180° phase-shifted with P1/A1. The delay between the filter sections is approximately 4nsec.

For correct sampling of the input signal by the P<sup>2</sup>CCD, it is necessary that the low level (+2V) of the clock signals P2 and P1 remains constant. To achieve this, the clock-signals P2 and P1 are measured on unit 10, which results in a feedback signal CLF of approximately +3.6V (clock-pulse amplitude feedback signal).

This voltage is applied to the base of transistor V3403 via low-pass filter R3436/C3418. A stable reference voltage of +3.6V is applied to the base of transistor V3404. In this way, variations of the low level (+2V) of the clock-signals P2 and P1 result in a variation of the signal level on the collector of transistor V3404. This variation is then fed back via emitter-follower V3401 to a current source pin 1 of the clock-pulse generator D3401.

The clock-pulse generator is driven by a signal CLKDR from pin 2 of flip-flop D3209 and routed via D3211 as signals P<sup>2</sup>CCD clock and P<sup>2</sup>CCD clock to unit A34.

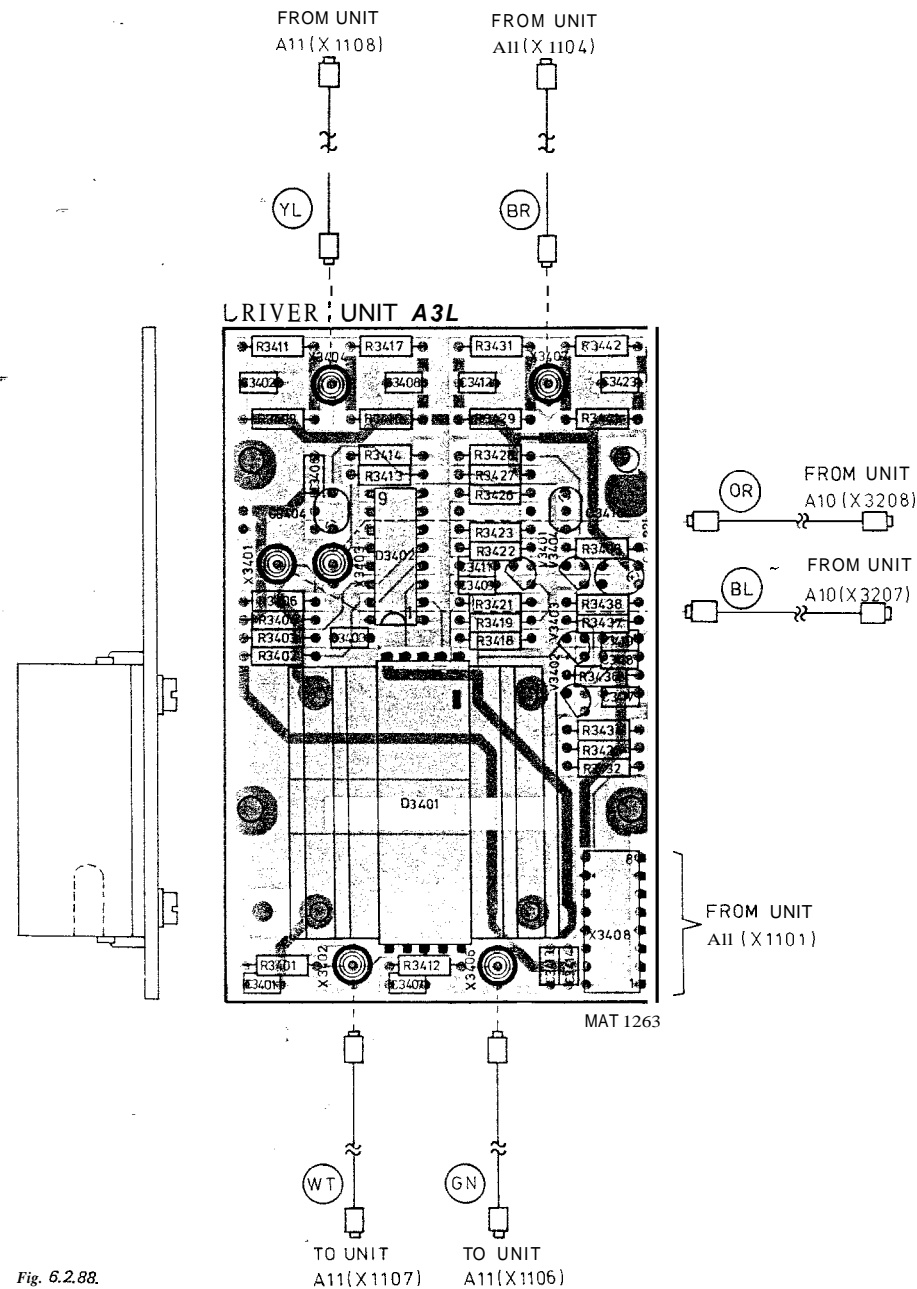
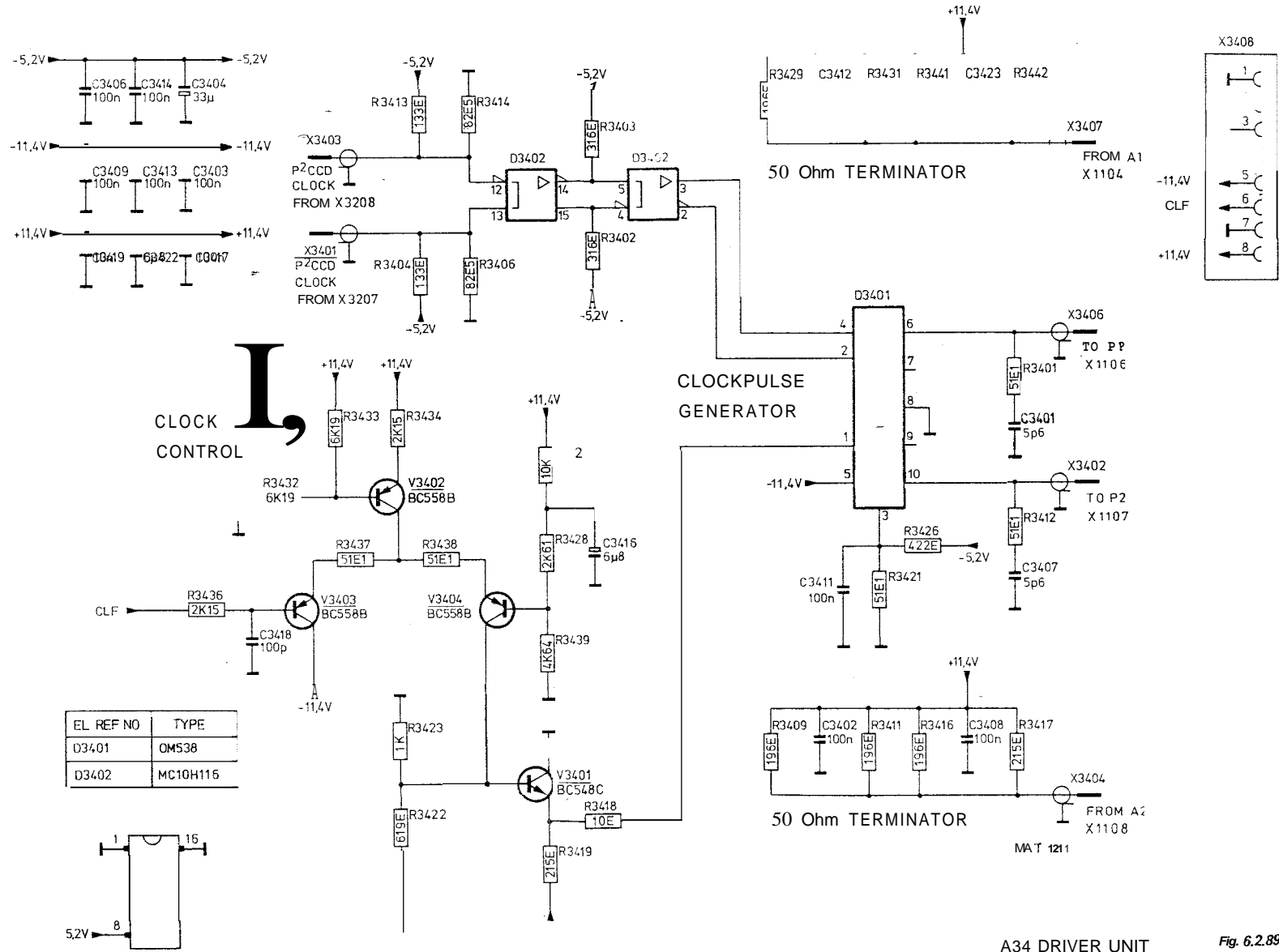
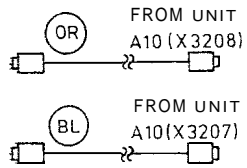

Fig. 6.2.88.



A34 DRIVER UNIT

Fig. 6.2.89.



V FROM UNIT A11 (X1101)

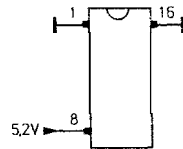

## 7. DISMANTLING THE INSTRUMENT

### 7.1. WARNINGS

**WARNING:** The opening of covers or removal of parts, except those to which access can be gained by hand, is likely to expose live parts, and **also** accessible terminals may be live. The instrument shall be disconnected from all voltage sources before any adjustment, replacement or maintenance and repair during which the instrument will be opened. **If** afterwards any adjustment, maintenance or repair of the opened instrument under voltage is inevitable, it shall be carried out only by a qualified person who is aware of the hazard involved. Bear in mind that capacitors inside the instrument may still be charged even if the instrument has been separated from all voltage sources.

**ATTENTION:** This section provides the dismantling procedures required for the removal of components during repair operations. All circuit boards removed from the oscilloscope should be adequately protected against damage, and all normal precautions regarding the use of tools must be observed. During dismantling procedures, a careful note must be made of all disconnected leads that they may be reconnected to their correct terminals during assembly. Damage may result if the instrument is switched on when a circuit board has been removed, or if a circuit board is removed within one minute after switching off the instrument.

**WARNING:** The E.H.T. cable is unbreakably connected to the E.H.T. unit (**disconnection at C.R.T.**). When the E.H.T. cable to the post-acceleration anode of the C.R.T. is disconnected at the C.R.T. unit end, the E.H.T. cable must be discharged immediately by shortening them to earth.

7.2. REMOVING THE COVERS

To remove the instrument covers, proceed as follows:  
- Both upper and lower cabinet plates can be removed after slackening the four quick-release fasteners at the corners of each plate. To prevent the fasteners coming apart, do not slacken more than two turns.

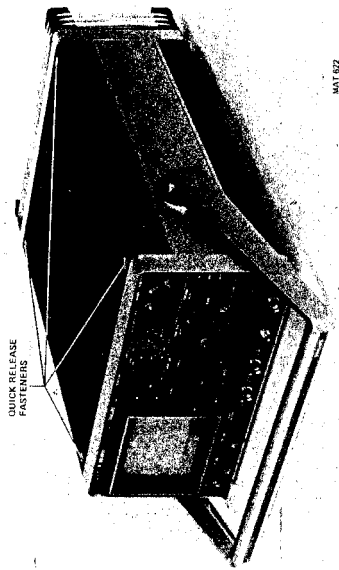

MAT 822

Fig. 7.2.1. Removing the instrument covers.

7.3. ACCESS TO PARTS FOR CHECKING AND ADJUSTING PROCEDURE

Adjusting elements are accessible after removing the instrument covers.  
Only for measurements and adjustments on the AC POWER unit A16 and DC POWER unit A15 the upper cabinet plate has to be removed.

Remove the six screws that secure the rear panel to the instrument

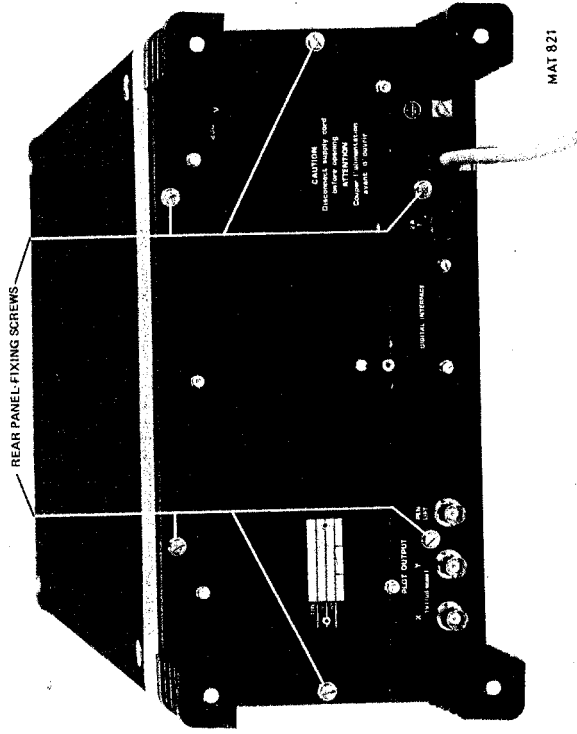

Fig. 7.2.2.

Unit A16 which is mounted on the rear panel can be placed outside the instrument by pulling the rear panel outwards.  
For better access to unit A15 both the upper and lower screening plates can be removed.

## 8. CHECKING AND ADJUSTING

Before starting with the CHECKING and ADJUSTING procedure check the instruments specification by means of the PERFORMANCE CHECK procedure on page 8-29.

**WARNING:** The opening of covers or removal of parts, except those to which access can be gained by hand, is likely to expose live parts, and also accessible terminals may be live. The instrument shall be disconnected from all voltage sources before any adjustment, replacement or maintenance and repair during which the instrument will be opened. If afterwards any adjustment, maintenance or repair of the opened instrument under voltage is inevitable, it shall be carried out only by a qualified person who is aware of the hazard involved. Bear in mind that capacitors inside the instrument may still be charged even if the instrument has been separated from all voltage sources.

### 8.1. GENERAL INFORMATION

The following information provides the complete checking and adjusting procedure for the oscilloscope. AS various control functions are interdependent, a certain order of adjustment is often necessary. The procedure is, therefore, presented in a sequence which is best suited to this order, cross-reference being made to any circuit which may affect a particular adjustment.

Before any check or adjustment, the instrument must attain its normal operating temperature.

- Where possible, instrument performance is checked before an adjustment is made.
- Warming-up time under average conditions is 30 minutes.
- All limits and tolerances given in this section are calibration guides and should not be interpreted as instrument specifications unless they are also published in chapter 1.2. characteristics.
- Tolerances given are for the instrument under test and do not include test equipment error.
- The most accurate display adjustments are made with a stable, well-focused, low-Intensity display. Unless otherwise noted, adjust the Intensity, Astigmatism, Focus and Trigger Level controls as needed.

## 8.1.1. Recommended test equipment

82

| Type of instrument                                  | Specifications   | Used for  | Example of recommended instrument                       |
|---|--|---|---|
| 1. Constant amplitude sine-wave generator           | Freq. 200 kHz ... 60 MHz<br>Constant amplitude of 12 mV p-p ... 1.2 v p-p  | Bandwidth check of vertical channels and triggering   | Tektronix SG 503 + SG 504                               |
| 2. Time marker generator                            | Repetition rate 0.5 s ... 20 ns  | Checking and adjusting of sweep rates   | Tektronix TG 501  |
| 3. Square-wave calibration generator                | Rise time $\leq 200$ ns<br>Voltage 10 mV up to (for pretereiice) 30 V<br>Duty cycle 50 %<br>Rise time $\leq 1$ nsec.   | Checking and adjusting of square-wave response of vertical channels and trygering   | Generator with additional attenuator unit. Partly PG506 |
| 4. L.F. sine-wave/square-wave generator             | Sine-wave: 1 Hz ... 1 MHz/0 ... 30 V<br>Square-wave: 1 Hz ... 1 MHz/0 ... 30 V<br>Rise time $\leq 100$ ns              | Checking the trigger sensitivity<br>Checking and adjusting square-wave response of for instance attenuator unit<br>See points 1 and 3 | PM 5129   |
| 5. Cables, T-piece, terminations for the generators | General Radio types for fast rise-time squdre-wave and high frequency sine. wave.<br>BNC-types for other applications. | See points 2 and 4.   |   |
| 6. Dummy probe 2 : 1                                | $1 \text{ M}\Omega \pm 0.1 \% // 25 \text{ pF}$  | Adjustment of input capacitance.  |   |
| 7. Trimming tool kit                                |  | Adjustments   | PHILIPS 800 NTX - 4822 310 50015                        |
| 8. Variable mains transformer                       | Well-insulated output voltage 90 ... 264 Va c.   | Checking influence of mains voltage variations and adjustment of power supply.  | PHILIPS ord. number 2422 529 00005                      |
| 9. Moving-iron meter                                |  | Checking the power consumption of the instrument.   |   |
| 10. Oscilloscope                                    | The bandwidth must be the same or higher than the bandwidth of the instrument under test.                              | Various measurements.   | PM 3262 PHILIPS   |
| 11. Digital multimeter                              | Wide voltaye, current and resistance ranges. Required accuracy 0.1 %.  | Checking the instrument under test.   | PHILIPS PM 2527   |

## 8.1.2 Preliminary settings

- No input signals connected.
  - All pushbuttons released and all switches in the CAL position.
- A trace will now appear within the upper two divisions of the screen.
- Clear all the four memories ACCU - ST01 - ST02 and ST03.

83





| ADJUSTMENT                             | ADJUSTING ELEMENT + UNIT   | ADJUSTING RESULT OR CHECK RESULT  | RECOMMENDED INPUT SIGNALS  | EXAMPLE OF MEASURING INSTRUMENT | CHAPTER            |
|--|--|---|--|---------------------------------|--------------------|
| Square wave response (Ch A, Ch B, X1)  | R2036 - (A21)<br>C2007 - (A21)<br>C2004<br>C2047<br>C2429<br>C2523 | Pulse top errors may not exceed 1 subdivision   | Square wave signal of 1 MHz - rise time $\leq 1$ ns to X3  | -                               | 8.3.6.2            |
| Ch A, square wave response in ADD mode | -  | No change in square wave response when operating the ADD function   | -  | -                               | 8.3.6.3            |
| Ch B, square wave response in ADD mode | -  | No change in square wave response when operating the ADD function   | -  | -                               | 8.3.6.3            |
| Square wave response channel B, INVERT | -  | No change in square wave response when operating the INVERT function  | -  | -                               | 8.3.6.3            |
| Bandwidth                              | -  | Vertical deflection must be 4 divisions minimum at 50 MHz. Display can be shifted more than 15 divisions on both sides. Rejection factor better than 100  | Sine wave signal of 12 mV <sub>pp</sub> - 50 MHz   | Tektronix SG 503 + SG 504       | 8.3.6.4            |
| OFFSET control range                   | -  | -   | Sine wave signal of 1.2 V <sub>pp</sub> - 20 MHz   | Tektronix SG 503 + SG 504       | 8.3.6.5            |
| Common mode rejection                  | -  | -   | Sine wave signal of 800 mV <sub>pp</sub> - 2 MHz   | Tektronix SG 503 + SG 504       | 8.3.6.6            |
| TIME COEFFICIENTS Recurrent mode       | R2958 (A22)<br>R2911 (A22)   | Correct 20 ns range<br>Correct start point of the trace on the screen   | Square wave signal of 100 mV <sub>pp</sub> with a repetition rate of 20 msec to X3   | Tektronix TG 501                | 8.3.7.1            |
| ROLL mode                              | -  | Correct ROLL mode in 0.5 V/div and 1 V/div  | Square wave signal of 20 ns to X3  | Tektronix TG 501                | 8.3.7.1            |
| Effective delay                        | -  | Correct effective delay (t <sub>1</sub> = 10 ns)  | Square wave signal with a repetition rate of 0.5 ns  | Tektronix TG 501                | 8.3.7.2            |
| Single shot                            | -  | Accu is reflected   | Square wave voltage of 2.4 V <sub>pp</sub> - 100 MHz - rise time $\leq 3$ ns   | PM 5129                         | 8.3.7.3            |
| Multiple                               | -  | All four memories are reflected   | Square wave signal of 1.2 V <sub>pp</sub> - 1 kHz  | PM 5129                         | 8.3.7.4            |
| VCO                                    | C1213  | 0.2 μs/div - V <sub>cc</sub> = 400mV  | Square wave signal of 1.2 V <sub>pp</sub> - 1 kHz  | PM 5129<br>PM 5129 or PM 5127   | 8.3.7.5<br>8.3.7.6 |
| TRIGGERING                             | R2957 - (A22)  | Triggered display   | Sine wave signal of 20 mV <sub>pp</sub> - 2 kHz to X3  | PM 5129                         | 8.3.8              |
| Trigger sensitivity                    | -  | Starting point trace on occurrence of sensitive signal edge when the SLOPE switch is operated   | Sine wave signal of 200 mV <sub>pp</sub> - 2 kHz to X3   | PM 5129                         | 8.3.8              |
| Trigger mode and level                 | -  | Correct LEVEL function  | Sine wave signal of 400 mV <sub>pp</sub> - 2 kHz to X3   | PM 5129                         | 8.3.8              |
| Trigger level AUTO                     | -  | Trigger point can be shifted over total signal amplitude when operating the LEVEL control   | Sine wave signal of 240 mV <sub>pp</sub> - 100 Hz to X3  | PM 5129                         | 8.3.8              |
| Trigger level EXT                      | -  | Trigger point can be shifted over total signal amplitude when operating the LEVEL control   | Sine wave signal of 240 mV <sub>pp</sub> - 100 Hz to X3  | PM 5129                         | 8.3.8              |
| Trigger level EXT 10                   | -  | Trigger point can be shifted over total signal amplitude when operating the LEVEL control   | Sine wave signal of 300 mV <sub>pp</sub> - 100 Hz to X3  | PM 5129                         | 8.3.8              |
| Trigger sensitivities                  | -  | Triggered display in AUTO<br>Triggered display in AUTO<br>Triggered display in AC<br>Triggered display in DC<br>Triggered display in DC<br>Triggered display in EXT<br>Triggered display in EXT<br>Triggered display in EXT 10<br>Triggered display in EXT 10 | Sine wave signal to X3<br>100 Hz - 0.75 div<br>20 kHz - 0.75 div<br>10 Hz - 0.75 div<br>10 MHz - 1.5 div<br>10 MHz - 0.15 V<br>10 MHz - 0.3 V<br>50 MHz - 1 V<br>300 mV p-p - 40 MHz to X4 | Tektronix SG 503 + SG 504       | 8.3.8              |
| Triggering of mains frequency          | -  | Triggered display   | When voltage level set at 200 mV <sub>pp</sub> to X3   | Tektronix SG 503 + SG 504       | 8.3.8              |
| TV triggering                          | R2910 (A22)  | Correct trigger delay functioning   | 625 lines, positive video amplitude 0.5 division   | -                               | 8.3.8              |
| Trigger delay                          | -  | Correct trigger delay functioning   | Sine wave signal of 200 mV <sub>pp</sub> - 1 ns to X3  | -                               | 8.3.8              |

| ADJUSTMENT                         | ADJUSTING ELEMENT + UNIT | ADJUSTING RESULT OR CHECK RESULT   | RECOMMENDED INPUT SIGNALS                                     | EXAMPLE OF MEASURING INSTRUMENT | CHAPTER |
|------------------------------------|--------------------------|--|---|---------------------------------|---------|
| X-Y MODE                           | -                        | Straight line with an angle of 45° with the positive horizontal axis           | Sine wave signal of 240 mV <sub>pp</sub> - 2 MHz to X3 and X4 | -                               | 8.3.9   |
| RANGE INDICATION                   | -                        | Correct V/div display change when connecting probe with range indication       | -   | -                               | 8.3.10  |
| PLOTTER OUTPUTS                    | -                        | Correct plotting   | Square wave signal  | PM 5129                         | 8.3.11  |
| PERIODIC AND RANDOM DEVIATIONS     | -                        | Ripple-noise - instability of the trace and microcopy $\leq 2$ mm              | -   | -                               | 8.3.12  |
| EFFECT OF MAINS VOLTAGE VARIATIONS | -                        | No change in trace height and width when mains voltage is varied by + or -10 % | CAL signal to X3 and X4                                       | -                               | 8.3.12  |

8-8

## 8.3. CHECKING AND ADJUSTING PROCEDURE

## 8.3.1. Powersupply

*Power consumption*

- Check that the mains adapter switch S45 has been set to the local mains voltage and connect the instrument to such a voltage.
- Switch the oscilloscope on and check that the pilot lamp on POWER ON the front panel lights UP.
- Check that the current consumption does not exceed 300 mA at 220 V local mains and 600 mA at 117 V local mains. (Measured with a moving-iron meter.)

*+12 V supply voltage*

- Check at nominal mains voltage that the voltage on the positive pole of C1513 on unit A15 is  $+12.6 \text{ V} \pm 1\%$ ; if necessary readjust potentiometer FEEDBACK R1646 on unit A16.
- Check that this voltage does not vary more than  $\pm 60 \text{ mV}$  when the mains voltage is varied between 200 V and 265 V or between 100 V and 130 V.
- Check that the +5 V on the positive pole of C1527 on unit A15 is  $+5 \text{ V} \pm 0.25 \text{ V}$ .
- Check that the oscilloscope starts at 180 V or 90 V.

*Frequency*

- Set the mains input voltage to 180 V or 90 V.
- Check that the voltage on the positive pole of C1513 on unit A15 has a 100 Hz ripple that does not exceed 10 mV. If necessary; readjust potentiometer FREQ. R1647 on unit A16.

AC POWER UNIT A16

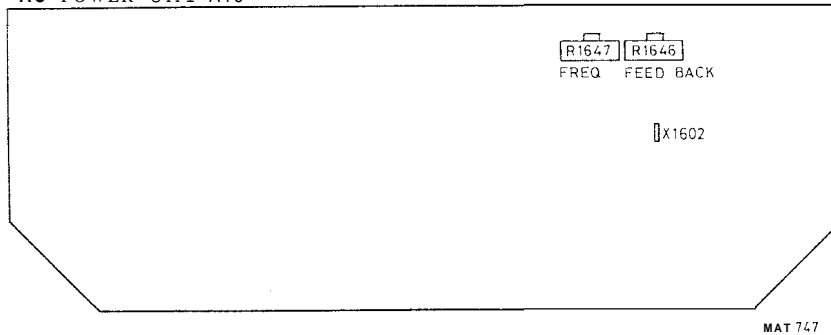

Fig. 8.3.1.

## 8.3.2. Cathode-ray-tube circuit

*Cathode voltage*

- Check that the voltage on testpoint X1502 on unit A15 is  $-1.5 \text{ V}$ .
- If necessary; readjust potentiometer R1591 on unit A15.

*Intensity*

- Set the front panel INTENS control R15 to  $90^\circ$  from its left hand stop.
- Adjust potentiometer R1589 on unit A15 in such a way that the trace is just not visible

*Focus and astigmatism*

- Depress pushbutton DISPLAY STOI S2.
- Depress pushbutton WRITE S12-A.
- Set channel A AMPL/DIV switch S20 to position 0.2 V/div. (40 mV/div. on the screen and in the alphanumeric display).
- Set TIME/DIV switch S23 to position 50 ms/div.
- Depress pushbutton AUTO S29-A of the trigger mode selector switch.
- Depress pushbutton Y X5 S16-B.
- Apply a sine-wave voltage of 240 mV-2 kHz to the A-input socket X3.
- Depress pushbutton SAVE STOI S8.
- Depress pushbutton LOCK S12-B.
- Depress pushbutton DOTS S17.
- Set FOCUS LINE potentiometer R1588 on unit A15 in its mid-position.
- Set the front panel INTENS control R15 to maximum brightness.
- Adjust FOCUS potentiometer R1506 on unit A15 and ASTIGMATISM potentiometer R1587 on unit A15 for a sharp and well-defined trace over the whole screen area.
- Check that the trace remains focused when the intensity is varied.

DC POWER UNIT A15

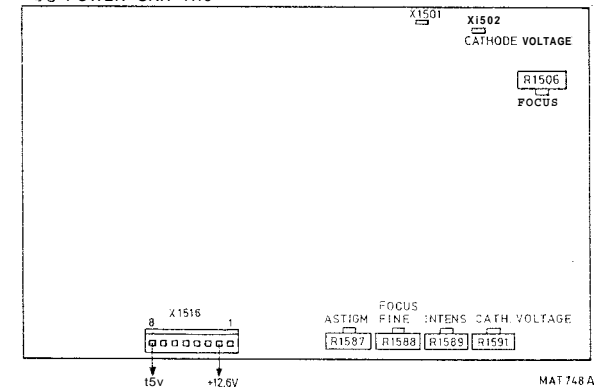

Fig. 8.3.2.

*Trace rotation*

- Release push-button DOTS S17.
- Depress push-button WRITE S12-A.
- Depress both push-buttons CLEAR S11 and SAVE STOI S8 simultaneously.
- Set the STOI Y POSITION control R4 in such a way that the trace is placed in the centre of the screen.
- Check that the trace runs exactly in parallel with the horizontal graticule lines; if necessary, readjust the TRACE ROTATION screw driver control R16 on the front panel.
- Release push-button DISPLAY STOI S2.
- Remove the input signal.



8.3.3. Pre-adjustment P<sup>2</sup>CCD circuit

- Check that the trace does not jump when the TIME/DIV switch S23 is switched between positions 0.2 ms/div and 0.5 ms/div.
- If necessary, readjust potentiometer R3057 on unit A21

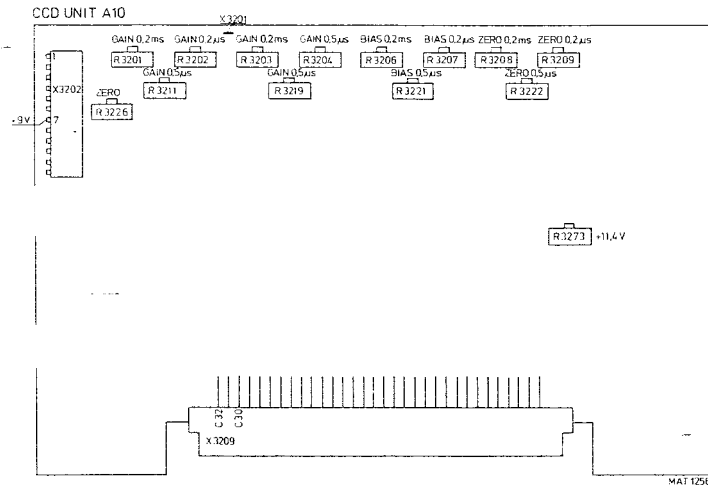

Fig. 8.3.5.

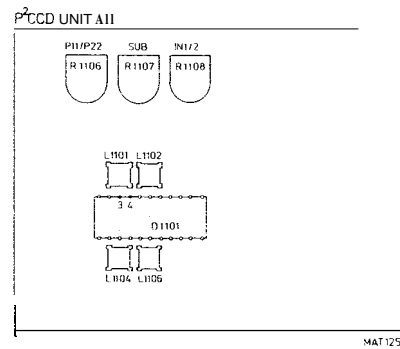

Fig. 8.3.6.

8.3.3.1. P<sup>2</sup>CCD adjusting procedure

**IMPORTANT:** Before adjusting the P<sup>2</sup>CCD be sure that the channels are adjusted correctly in the direct mode.

## PRELIMINARY SETTINGS

- Depress the channel A ON-OFF pushbutton S32
  - Release the channel B ON-OFF pushbutton S34
  - Set the channel A variable AMPL/DIV control R7 in the CAL position
  - Depress RECURR S38-C
  - Depress pushbutton AUTO S29
  - Depress pushbutton A of the trigger selection switch S39
  - Depress pushbutton ACCU DISPLAY S1
  - Release pushbutton STO1, STO2 and STO3, S2, S3 and S4
  - Depress pushbutton WRITE S12-A
  - Depress pushbutton X = t S15-A
  - Depress pushbutton Y x 5 S16-B
  - Set the X-MAGN control R2 into its CAL position
  - Set the TIME/DIV switch S23 to position 0,5ms/div
  - Set the channel A AMPL/DIV switch to 0,1V/div
  - Depress the channel A 0 pushbutton and adjust the trace to the centre of the screen with the OFFSET control and release the 0 pushbutton
  - Apply a sine-wave of 1kHz, with an amplitude to obtain a display of 8 divisions on the screen, to the channel A input socket X3
  - Set the TIME/DIV switch S23 to position 0,2ms/div
  - Switch off the instrument
  - Connect point C22 of pcb connector X2004 (Unit A20) to ground
  - Connect points C30 and C32 of pcb connector X3209 (Unit A10) to ground
  - Connect the measuring oscilloscope to signal V OUT (testpoint X3201 unit A10) and trigger it on the negative edge of the signal NULIN (testpoint X902 unit 9)
- Settings of the measuring oscilloscope: 0,5V/div; 1ms/div; zero line in the centre of the screen.
- The use of a 10:1 probe is necessary!
- Switch on the instrument again

## ADJUSTING PROCEDURE

Low frequency P<sup>2</sup>CCD adjustment0,2ms/div P<sup>2</sup>CCD low frequency adjustment:

- Adjust the positive supply voltage with R3273 to  $+11.4 \pm 0.05V$ .  
Measuringpoint: X3202 point 5.
- Check that the negative supply voltage is between  $-11,3V$  and  $-11,5V$   
Measuringpoint: X3202 point 4.
- Adjust the following potentiometers to the indicated voltages:  
R1107 to  $+2V \pm 0,5V$  (SUB) measuring point: IC1101 pin 3.  
R1106 to  $+6V \pm 0,1V$  (P11/P22) measuring point: IC1101 pin 4.  
R3206 to  $+9V \pm 0,5V$  (BIAS) measuring point: X3203 pin 7.  
R3208 (ZERO) to midposition  
A3201 (GAIN) to midposition
- Turn R1108 (IN1/IN2) completely clockwise, then turn slowly counter-clockwise until two sine-wave signals appear on the screen of the measuring oscilloscope.  
Turn on until the sine waves abruptly disappear.

**NOTE:** If the NULIN lines exceed + and  $-2000mV$  readjust to zero with potentiometer R3208 (ZERO)

Now turn R1108 slowly clockwise, just so far that two stable sine-waves are displayed on the screen of the measuring oscilloscope.

5. Set the measuring oscilloscope to 0,1V/div.
6. Adjust R3208 (ZERO) so that the NULIN signals on the measuring oscilloscope screen are at + and -1V level. Be sure that the signals are adjusted according to figure A.
7. Adjust R3226 in combination with R3208 so that the NULIN signals are at + and -1V level and are symmetrical around the zero line.
8. Adjust R3201 and R3203 (GAIN) for 8 divisions display on the PM3311.
9. Adjust R3206 (BIAS) for optimal covering of the two sine waves on the PM3311 screen.
10. After each change of 3206 start with point 6. again.
11. Apply a square-wave of 1kHz and check that the signal corresponds to fig.B. If necessary increase the SUB voltage with R1107 for approx. 3V.

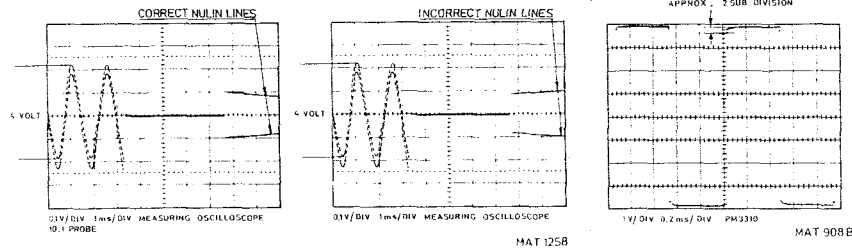

Fig. A.

Fig. B.

12. After each adjustment of R1107 start with point 4. again

**NOTE 1:** If point 9. is not successful, then try another value for P11/P22 ( $\pm 0,5V$ ). It may be necessary to increase the SUE voltage too. Start with point 4. again.

**NOTE 2:** Apply a sine-wave of 4 divisions amplitude and shift it by means of the OFFSET control over the screen. Check if the amplitude changes no more than 0,5 sub-division, otherwise start with point 9. again. Reset the input signal to 8 divisions.

#### High frequency P<sup>2</sup>CCD adjustments

##### 0,5 $\mu$ s/div P<sup>2</sup>CCD adjustment:

1. Set the TIME/DIV switch to 0,5 $\mu$ s/div.
  2. Apply a sine-wave of 400kHz with an amplitude to obtain a display of 8 divisions display on the PM3311 screen.
  3. Adjust L1101, L1102, L1104 and L1106 so that:
    - a. The NULIN signals on the measuring oscilloscope screen are at + and -1V level.
    - b. The display of the PM3311 shows about 8 divisions amplitude.
    - c. The covering of the two sine waves is optimal on the screen of the PM3311.
    - d. Check the 1 $\mu$ s/div position for correct display.
 Eventually optimise the adjustment of the coils between the positions 0,5 $\mu$ s/div and 1 $\mu$ s/div.
  4. Disconnect the ground connection of X3209 points C30 and C32.
  5. Adjust R3222 so that the NULIN signals on the measuring oscilloscope screen are at + and -1V level. Be sure that the signals are adjusted according to figure A.
  6. Adjust R3211 and R3219 (GAIN) for 8 divisions display on the screen of the PM3311.
  7. Adjust R3221 (BIAS) for optimal covering of the two sine-waves on the PM3311 screen.
  8. After each adjustment of R3221 start with point 5. again.
- This is the end of the 0,5 $\mu$ s/div P<sup>2</sup>CCD adjustment.

**NOTE 1:** Apply a sine-wave of 4 divisions amplitude and shift it by means of the OFFSET control over the screen. Check if the amplitude changes no more than 0,5 sub-division, otherwise start with point 7. again. Reset the input signal to 8 divisions.

##### 0,2 $\mu$ s/div P<sup>2</sup>CCD adjustment:

1. Adjust R3209 so that the NULIN signals on the measuring oscilloscope are at + and -1V level.
2. Adjust R3202 and R3204 (GAIN) for 8 divisions display on the screen of the PM3311.
3. Adjust R3207 (BIAS) for optimal covering of the two sine-waves on the PM3311 screen.
4. After each adjustment of R3207 Start with point 1. again.

**NOTE 1:** If it is not possible to adjust for 8 divisions amplitude, decrease the SUB voltage and readjust completely.

**NOTE 2:** Apply a sine-wave of 4 divisions amplitude and shift it by means of the OFFSET control over the screen. Check if the amplitude changes no more than 0,5 sub-division, otherwise start with point 3. again.

### 8.3.4. Balance adjustments

The adjustments of the vertical channels A and B are identical.

The knobs, sockets and adjusting elements of channel B are shown in brackets after those of channel A. These balance adjustments influence one another and must, therefore, be readjusted in the sequence in which they are described.

#### 8.3.4.1. Vertical amplifier balances

0-DC balance

- Set channel A (B) AMPL/DIV switch S20 (S22) in position 50 mV/div.
- Check that the trace does not jump when pushbutton O S31 (S35) is operated.
- If necessary, readjust potentiometer R2642 (R2526) on unit A21 for minimum jump
- Release the channel A (B) O pushbutton S31 (S35).

Attenuator balance

- Set the trace in the centre of the screen with the channel A (B) OFFSET control R10 (R12).
- Release pushbutton DOTS 16-C.
- Set TIME/DIV switch S23 to position 0.5 ms/div.
- Depress channel A (B) ON-OFF pushbutton S32 (S34) to ON.
- Check that the trace does not jump when the AMPL/DIV switch S20 (S22) is switched between 10 mV/div, 20 mV/div and 50 mV/div.
- If necessary readjust potentiometer R2643 (R2527) on unit A21 for minimum jump.

X1/X10 balance

- Check that the trace does not jump, when the channel A (B) AMPL/DIV switch S20 (S22) is switched between positions 50 mV/div and 0.1 V/div.
- If necessary, readjust potentiometer R2657 (R2534) on unit A21 for minimum lump.

Continue balance

- Set channel A (B) AMPL/DIV switch S20 (S22) in position 50 mV/div.
- Check that the trace does not move when the channel A (B) AMPL/DIV continuous control R7 (R8) is rotated between minimum and maximum.
- If necessary, readjust potentiometer R2576 (R2416) on unit A21 for minimum shift.
- Release the channel A (B) ON-OFF pushbutton S32 (S34) to OFF.

Follow the same procedure for channel B.

Normal/Invert balance (ONLY for channel B)

- Depress channel B ON-OFF pushbutton S34 to ON.
- Check that the trace does not lump when the channel B OFFSET control S28 is pulled and pushed
- If necessary, readjust potentiometer R2411 on unit A21 for minimum jump.
- Push channel B OFFSET control S28 to normal.

#### 8.3.4.2. Triggerpoint symmetry

- Check that the voltage on testpoint X2707 is -1 V.
- If necessary, readjust potentiometer R2819 on the trigger-unit

#### 8.3.4.3. Trigger balances AC-DC

External

- Depress channel B ON-OFF pushbutton S34 to ON.
- Set TIME/DIV switch S23 to position 0.5 ms/div.
- Set the channel B AMPL/DIV switch S22 to position 1 V/div (0.2 V/div on the screen and in the alphanumeric display).
- Depress pushbutton EXT S39-C of the trigger source selector switch.
- Depress pushbutton AC S29-B of the trigger mode selector switch.
- Apply a sine-wave signal of 1.2 Vp-p - 2 kHz to the channel B input socket X4 as well as to the EXT input socket X6.
- Set the LEVEL control R9 for a stable display.

- Depress pushbutton SAVE STOI S8.
- Check that in double channel operation the dot-poin system still functions correctly.
- Adjust potentiometer **R2039** on unit A20 for minimum cross-talk between the two channels A and B
- Remove the input signal.
- Release pushbutton STOI DISPLAY S2.

#### CALibration voltage

- Check that the amplitude of the CAL voltage on CAL terminal X1 is 3V  $\pm$  0.7%.
- If necessary, readjust potentiometer **R2017** on unit A20.
- Check that the frequency of the CAL voltage is 2.5 kHz.

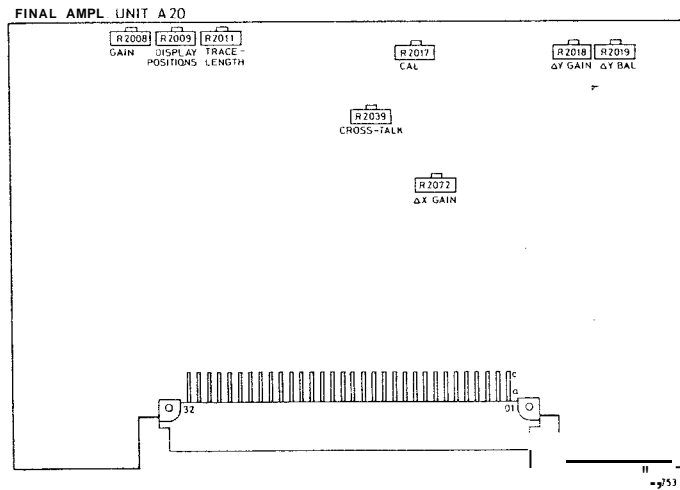

Fig. 8.3.7.

#### 8.3.6. Vertical channels

The adjustments of the vertical channels A and B are identical. The knobs, sockets and adjusting elements of channel 3 are shown in brackets after those of channel A.

##### 8.3.6.1. Vertical amplifier sensitivity adjustments

Before checking the sensitivities, check the balances in accordance with section 8.3.4.

##### Channel B gain x1

- Depress the channel A and B ON-OFF pushbuttons **S32** and **S34** to ON.
- Release the channel A and B AC-DC switches **S30** and **S36** and the 0 switches **S31** and **S35**.
- Set the channel A and B AMPLIDIV switches **S20** and **S22** to position 0.2 V/div 140 mV/div on the screen and in the alphanumeric display).
- Set the channel A and B AMPLIDIV continuous control **R7** and **R8** in the CAL position.
- Set the channel A and B OFFSET controls **R10** and **R12** so that the traces are shifted to the centre of the screen.
- Depress pushbutton **RECURR** **S38-C**.
- Set the TIMEIDIV switch **S23** to position 0.5 ms/div.
- Depress pushbutton AUTO of the trigger mode selector switch **S29**.
- Depress pushbutton B of the trigger source selector switch **S39**.
- Depress the **ACCU DISPLAY** pushbutton **S1**.
- Release the DISPLAY pushbuttons **STOI** - **STO2** and **STO3**, **S2**-**S3** and **S4**.
- Depress pushbutton **WRITE** **S12-A**.
- Depress pushbutton **X** = **S15-A**.
- Depress pushbutton **Y** x 5 **S16-B**.
- Set the XMAGN control **R2** to its CAL position.
- Apply a square-wave signal of 240 mVp-p - 2 kHz to the channel B input socket **X4**.
- Adjust potentiometer **R3029** on unit A21 for a trace height of 6 divisions.

##### Channel A gain x1

- Depress pushbutton A of trigger source selector switch **S39**.
- Apply a squarewave signal of 240 mVp-p - 2 kHz to the channel A input socket **X3**.
- Adjust potentiometer **R2661** on unit A21 for a trace height of 6 divisions.

##### Channel A (B) gain x10

- Set channel A (B) AMPLIDIV switch **S20** (**S22**) to position 20 mV/div (4 mV/div on the screen and in the alphanumeric display).
- Apply a square-wave signal of 24 mVp-p - 2 kHz to channel A (B) input **X3** (**X4**).
- Adjust potentiometer **R2658** (**R2536**) on unit A21 for a trace height of 6 divisions.

##### L.F. Correction

- Set channel A (B) AMPLIDIV switch **S20** (**S22**) to position 0.2 V/div (40 mV/div on the screen and in the alphanumeric display).
- Apply a square-wave signal of 240 mVp-p - 100 Hz to channel A (B) input socket **X3** (**X4**).
- Set TIMEIDIV switch **S23** to position 1 ms/div.
- Check that the pulse top is straight: if necessary, readjust potentiometer **R2611** (**R2481**) on unit **A21**.

##### AC-DC channel A (B)

- Depress push-button AC-DC of channel A (B) - **S30** (**S36**)
- Check that the pulse top difference is more than 0.5 div.

##### Sampling loop gain

- Set the TIMEIDIV switch **S23** to position 0.2 ms/div.
- Depress the channel A and B ON-OFF pushbuttons **S32** and **S34** to ON.
- Apply a squarewave signal of 240 mV - 2 kHz to channel A input socket **X3**.
- Set the channel B OFFSET control **R12** so that the trace is set in the middle of the screen.
- Set the TIMEIDIV switch **S23** to position 0.5 ms/div.

Now turn R1108 slowly clockwise, just so far that two stable sine-waves are displayed on the screen of the measuring oscilloscope.

5. Set the measuring oscilloscope to 0,1V/div.
6. Adjust R3208 (ZERO) so that the NULIN signals on the measuring oscilloscope screen are at + and -1V level. Be sure that the signals are adjusted according to figure A.
7. Adjust R3226 in combination with R3208 so that the NULIN signals are at + and -1V level and are symmetrical around the zero line.
8. Adjust R3201 and R3203 (GAIN) for 8 divisions display on the PM3311.
9. Adjust R3206 (BIAS) for optimal covering of the two sine waves on the PM3311 screen.
10. After each change of 3206 start with point 6. again.
11. Apply a square-wave of 1kHz and check that the signal corresponds to fig.B. If necessary increase the SUB voltage with R1107 for approx. 3V.

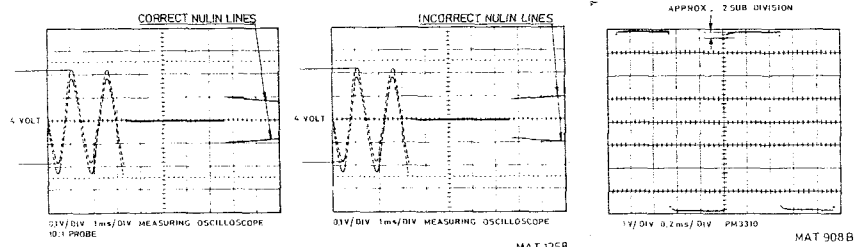

Fig. A.

Fig. B.

12. After each adjustment of R1107 start with point 4. again

**NOTE 1:** If point 9. is not successful, then try another value for P11/P22 ( $\pm 0,5V$ ). It may be necessary to increase the SUE voltage too. Start with point 4. again.

**NOTE 2:** Apply a sine-wave of 4 divisions amplitude and shift it by means of the OFFSET control over the screen. Check if the amplitude changes no more than 0,5 sub-division, otherwise start with point 9. again. Reset the input signal to 8 divisions.

#### High frequency P<sup>2</sup>CCD adjustments

##### 0,5 $\mu$ s/div P<sup>2</sup>CCD adjustment:

1. Set the TIME/DIV switch to 0,5 $\mu$ s/div.
  2. Apply a sine-wave of 400kHz with an amplitude to obtain a display of 8 divisions display on the PM3311 screen.
  3. Adjust L1101, L1102, L1104 and L1106 so that:
    - a. The NULIN signals on the measuring oscilloscope screen are at + and -1V level.
    - b. The display of the PM3311 shows about 8 divisions amplitude.
    - c. The covering of the two sine waves is optimal on the screen of the PM3311.
    - d. Check the 1 $\mu$ s/div position for correct display.
 Eventually optimise the adjustment of the coils between the positions 0,5 $\mu$ s/div and 1 $\mu$ s/div.
  4. Disconnect the ground connection of X3209 points C30 and C32.
  5. Adjust R3222 so that the NULIN signals on the measuring oscilloscope screen are at + and -1V level. Be sure that the signals are adjusted according to figure A.
  6. Adjust R3211 and R3219 (GAIN) for 8 divisions display on the screen of the PM3311.
  7. Adjust R3221 (BIAS) for optimal covering of the two sine-waves on the PM3311 screen.
  8. After each adjustment of R3221 start with point 5. again.
- This is the end of the 0,5 $\mu$ s/div P<sup>2</sup>CCD adjustment.

**NOTE 1:** Apply a sine-wave of 4 divisions amplitude and shift it by means of the OFFSET control over the screen. Check if the amplitude changes no more than 0,5 sub-division, otherwise start with point 7. again. Reset the input signal to 8 divisions.

##### 0,2 $\mu$ s/div P<sup>2</sup>CCD adjustment:

1. Adjust R3209 so that the NULIN signals on the measuring oscilloscope are at + and -1V level.
2. Adjust R3202 and R3204 (GAIN) for 8 divisions display on the screen of the PM3311.
3. Adjust R3207 (BIAS) for optimal covering of the two sine-waves on the PM3311 screen.
4. After each adjustment of R3207 Start with point 1. again.

**NOTE 1:** If it is not possible to adjust for 8 divisions amplitude, decrease the SUB voltage and readjust completely.

**NOTE 2:** Apply a sine-wave of 4 divisions amplitude and shift it by means of the OFFSET control over the screen. Check if the amplitude changes no more than 0,5 sub-division, otherwise start with point 3. again.



### 8.3.4. Balance adjustments

The adjustments of the vertical channels A and B are identical.

The knobs, sockets and adjusting elements of channel B are shown in brackets after those of channel A. These balance adjustments influence one another and must, therefore, be readjusted in the sequence in which they are described.

#### 8.3.4.1. Vertical amplifier balances

0-DC balance

- Set channel A (B) AMPL/DIV switch S20 (S22) in position 50 mV/div.
- Check that the trace does not jump when pushbutton O S31 (S35) is operated.
- If necessary, readjust potentiometer R2642 (R2526) on unit A21 for minimum jump
- Release the channel A (B) O pushbutton S31 (S35).

Attenuator balance

- Set the trace in the centre of the screen with the channel A (B) OFFSET control R10 (R12).
- Release pushbutton DOTS 16-C.
- Set TIME/DIV switch S23 to position 0.5 ms/div.
- Depress channel A (B) ON-OFF pushbutton S32 (S34) to ON.
- Check that the trace does not jump when the AMPL/DIV switch S20 (S22) is switched between 10 mV/div, 20 mV/div and 50 mV/div.
- If necessary readjust potentiometer R2643 (R2527) on unit A21 for minimum jump.

X1/X10 balance

- Check that the trace does not jump, when the channel A (B) AMPL/DIV switch S20 (S22) is switched between positions 50 mV/div and 0.1 V/div.
- If necessary, readjust potentiometer R2657 (R2534) on unit A21 for minimum lump.

Continue balance

- Set channel A (B) AMPL/DIV switch S20 (S22) in position 50 mV/div.
- Check that the trace does not move when the channel A (B) AMPL/DIV continuous control R7 (R8) is rotated between minimum and maximum.
- If necessary, readjust potentiometer R2576 (R2416) on unit A21 for minimum shift.
- Release the channel A (B) ON-OFF pushbutton S32 (S34) to OFF.

Follow the same procedure for channel B.

Normal/Invert balance (ONLY for channel B)

- Depress channel B ON-OFF pushbutton S34 to ON.
- Check that the trace does not lump when the channel B OFFSET control S28 is pulled and pushed
- If necessary, readjust potentiometer R2411 on unit A21 for minimum jump.
- Push channel B OFFSET control S28 to normal.

#### 8.3.4.2. Triggerpoint symmetry

- Check that the voltage on testpoint X2707 is -1 V.
- If necessary, readjust potentiometer R2819 on the trigger-unit

#### 8.3.4.3. Trigger balances AC-DC

External

- Depress channel B ON-OFF pushbutton S34 to ON.
- Set TIME/DIV switch S23 to position 0.5 ms/div.
- Set the channel B AMPL/DIV switch S22 to position 1 V/div (0.2 V/div on the screen and in the alphanumeric display).
- Depress pushbutton EXT S39-C of the trigger source selector switch.
- Depress pushbutton AC S29-B of the trigger mode selector switch.
- Apply a sine-wave signal of 1.2 Vp-p - 2 kHz to the channel B input socket X4 as well as to the EXT input socket X6.
- Set the LEVEL control R9 for a stable display.

- Check that the trigger point does not shift when the trigger mode selector switch S29 is switched between AC and DC. If necessary, readjust potentiometer R2753, on unit A22 for minimum shift. in DC-mode.
- Remove the input signal from EXT input socket X6 and from channel B input socket X4.

#### A balance

- Depress channel A ON-OFF pushbutton S32 to ON.
- Release channel B ON-OFF pushbutton S34 to OFF.
- Set the channel A AMPL/DIV switch S20 to position 1 V/div (0.2 V/div on the screen and in the alphanumeric display).
- Depress pushbutton A S39-A of the trigger source selector switch.
- Depress pushbutton AC S29-B of the trigger mode selector switch.
- Apply a sine-wave signal of 1.2 Vp-p - 2 kHz to the channel A input socket X3.
- Set the LEVEL control R9 for a triggered display.
- Check that the trigger point does not move when the trigger mode selector switch S29 is switched between AC and DC.
- If necessary, readjust potentiometer R2861 on unit A22, in DC-mode.
- Remove the input signal from channel A input socket A3.

#### B balance

- Depress channel B ON-OFF pushbutton S34 to ON.
- Release channel A ON-OFF pushbutton S32 to OFF.
- Set the channel B AMPL/DIV switch S22 to position 1 V/div (0.2 V/div on the screen and in the alphanumeric display).
- Depress pushbutton B S39-B of the trigger source selector switch.
- Depress pushbutton AC S29-B of the trigger mode selector switch.
- Apply a sine-wave signal of 1.2 Vp-p - 2 kHz to the channel B input socket X4.
- Set the LEVEL control R9 for a triggered display.
- Check that the trigger point does not shift when the trigger mode selector switch S29 is switched between AC and DC.
- If necessary, readjust potentiometer R2859 on unit A22, in DC - mode.
- Release the channel B ON-OFF pushbutton S34 to OFF.
- Remove the input signal from channel B input socket X4.

#### LINE balance

- Depress pushbuttons EXT and EXT1-10 of the trigger source selector switch S39 simultaneously (LINE).
- Depress the channel A ON-OFF switch S32 to ON.
- Set TIME/DIV switch S23 to position 10ms/div.
- Apply a mains voltage derived signal via a mains transformer with an amplitude of 6 divisions to the channel A input socket X3.
- Check that the trigger point does not move when the trigger mode selector switch S29 is switched between AC and DC.
- If necessary readjust potentiometer R2857 on unit A22, in DC-mode.
- Remove the input signal from channel A input socket X3.

#### 8.3.4.4. Trigger amplifier balance

- Set TIME/DIV switch S23 to position 0.5 ms/div.
- Set the LEVEL control R9 in its mid-position.
- Depress pushbutton A S39-A of the trigger source selector switch.
- Depress pushbutton AUTO S29-C of the trigger mode selector switch.
- Apply a sine-wave signal of 1.2 Vp-p - 2 kHz to the channel A input socket X3.
- Check that the trigger point is situated in the middle of the signal amplitude.
- If necessary, readjust potentiometer R2867 on unit A22.

#### 8.3.4.5. Trigger point symmetry

- Depress pushbutton DC S29-A of the trigger mode selector switch.
- Set LEVEL control R9 in its mid-position.
- Check that the trigger point is situated in the middle of the signal amplitude.
- If necessary, readjust potentiometer R 2819 on unit A22.
- Remove the input signal from channel A input socket X3.

#### 8.3.5. Final amplifier adjustments

##### Vertical trace height

- Depress the channel A ON-OFF switch S32 to ON.
- Depress pushbutton A of the trigger source selector switch S39.
- Depress pushbutton AUTO of the trigger mode selector switch S29.
- Depress pushbutton Yx5 S16-B.
- Depress pushbutton WRITE S12-A.
- Depress the ACCU DISPLAY pushbutton S1.
- Set the TIME/DIV switch S23 to position 0.5 ms/div. ...
- Depress pushbutton CLEAR S11 and shift the trace to -1 div simultaneously.
- Apply a signal to channel A input socket X3 with an amplitude so high that the display on the C.R.T. screen is blinking at the upper side.
- Adjust potentiometer R2008 on unit A20 so that the display is blinking at + 4 divisions.
- If necessary, repeat this procedure.
- Remove the input signal.

##### Display positions ACCU - STOI - STO2 - STO3

- Depress the four ACCU - STOI - STO2 and STO3 DISPLAY pushbuttons S1-S2-S3 and S4.
- Depress pushbutton CLEAR S11, keep it in the depressed position and depress then the pushbuttons SAVE STOI S8, SAVE STO2 S9, SAVE STO3 S10 and LOCK S12-B
- Turn the ACCU - STOI - STO2 and STO3 Y POSITION controls R1-R4-R5 and R6 such that the four traces cover each other in the centre of the screen.
- Depress pushbutton Yx1 S16-A.
- Adjust potentiometer R2009 on unit A20 for a distance of two divisions between the traces.

##### Invert registers

- Depress pushbutton WRITE S12-A
- Set the channel A AMPL/DIV switch S20 to position 1 V/div
- Apply a sine-wave voltage of 1.2 Vp-p - 2 kHz to the channel A input socket X3.
- Depress pushbuttons SAVE STOI S8, SAVE STO2 S9 and SAVE STO3 S10.
- Pull the invert switches S5, S6 and S7 and check that STOI, STO2 and STO3 are inverted
- Push the switches S5, S6 and S7.
- Remove the input signal.

##### Horizontal trace length

- Clear STOI, STO2 and STO3.
- Adjust with potentiometer R2011 on unit A20 the length of the horizontal lines on the screen for 10 divisions.

##### Dot joint adjustments

- Release pushbutton DOTS S17.
- Depress the channel A ON-OFF pushbutton S32 to ON.
- Release the channel B ON-OFF pushbutton S34 to OFF.
- Depress pushbutton WRITE S12-A.
- Depress pushbutton Yx5 S16-B.
- Apply a sine-wave signal with a trace height for 6 divisions display and a frequency of 2 kHz to the channel A input socket X3.
- Set TIME/DIV switch S23 to position 0.2 ms/div.
- Depress pushbutton SAVE STOI S8.
- Depress DISPLAY pushbutton STOI S2.
- Release the ACCU - STO2 and STO3 DISPLAY buttons S1 - S3 and S4.
- Check that the dot join faults in vertical direction are equal for the positive going edge and the negative going edge of the signal.
- If necessary equalize these faults with potentiometer R2019 on unit A20.
- Eliminate the dot join faults by adjusting potentiometer R2018 on unit A20.
- Adjust potentiometer R2072 on unit A20 so that the dots on the screen are really connected with each other.
- Depress the channel B ON-OFF pushbutton S34 to ON.

- Depress pushbutton SAVE STOI S8.
- Check that in double channel operation the dot join system still functions correctly.
- Adjust potentiometer **R2039** on unit A20 for minimum cross-talk between the two channels A and B
- Remove the input signal.
- Release pushbutton STOI DISPLAY S2.

#### CALibration voltage

- Check that the amplitude of the CAL voltage on CAL terminal **X1** is 3V  $\pm$  0.7%.
- If necessary, readjust potentiometer **R2017** on unit A20.
- Check that the frequency of the CAL voltage is 2.5 kHz.

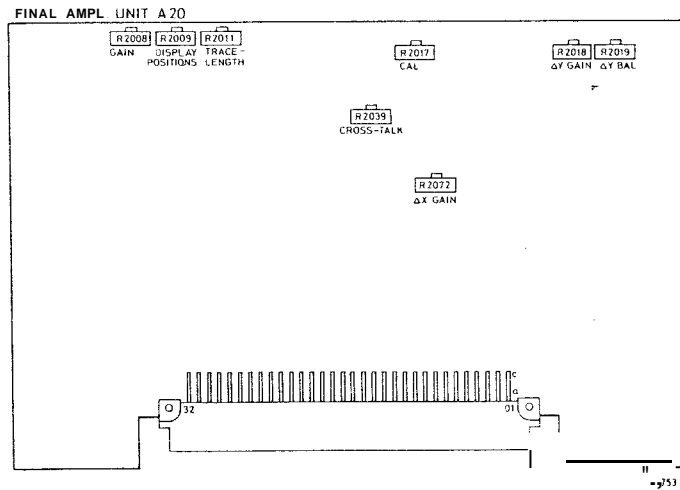

Fig. 8.3.7.

#### 8.3.6. Vertical channels

The adjustments of the vertical channels A and B are identical. The knobs, sockets and adjusting elements of channel 3 are shown in brackets after those of channel A.

##### 8.3.6.1. Vertical amplifier sensitivity adjustments

Before checking the sensitivities, check the balances in accordance with section 8.3.4.

##### Channel B gain x1

- Depress the channel A and B ON-OFF pushbuttons **S32** and **S34** to ON.
- Release the channel A and B AC-DC switches **S30** and **S36** and the 0 switches **S31** and **S35**.
- Set the channel A and B AMPLIDIV switches **S20** and **S22** to position 0.2 V/div 140 mV/div on the screen and in the alphanumeric display).
- Set the channel A and B AMPLIDIV continuous control **R7** and **R8** in the CAL position.
- Set the channel A and B OFFSET controls **R10** and **R12** so that the traces are shifted to the centre of the screen.
- Depress pushbutton **RECURR** **S38-C**.
- Set the TIMEIDIV switch **S23** to position 0.5 ms/div.
- Depress pushbutton AUTO of the trigger mode selector switch **S29**.
- Depress pushbutton B of the trigger source selector switch **S39**.
- Depress the ACCU DISPLAY pushbutton **S1**.
- Release the DISPLAY pushbuttons STOI - STO2 and STO3, S2-S3 and S4.
- Depress pushbutton WRITE **S12-A**.
- Depress pushbutton X = t **S15-A**.
- Depress pushbutton Y x 5 **S16-B**.
- Set the XMAGN control **R2** to its CAL position.
- Apply a square-wave signal of 240 mVp-p - 2 kHz to the channel B input socket **X4**.
- Adjust potentiometer **R3029** on unit A21 for a trace height of 6 divisions.

##### Channel A gain x1

- Depress pushbutton A of trigger source selector switch **S39**.
- Apply a square wave signal of 240 mVp-p - 2 kHz to the channel A input socket **X3**.
- Adjust potentiometer **R2661** on unit A21 for a trace height of 6 divisions.

##### Channel A (B) gain x10

- Set channel A (B) AMPLIDIV switch **S20** (**S22**) to position 20 mV/div (4 mV/div on the screen and in the alphanumeric display).
- Apply a square-wave signal of 24 mVp-p - 2 kHz to channel A (B) input **X3** (**X4**).
- Adjust potentiometer **R2658** (**R2536**) on unit A21 for a trace height of 6 divisions.

##### L.F. Correction

- Set channel A (B) AMPLIDIV switch **S20** (**S22**) to position 0.2 V/div (40 mV/div on the screen and in the alphanumeric display).
- Apply a square-wave signal of 240 mVp-p - 100 Hz to channel A (B) input socket **X3** (**X4**).
- Set TIMEIDIV switch **S23** to position 1 ms/div.
- Check that the pulse top is straight: if necessary, readjust potentiometer **R2611** (**R2481**) on unit **A21**.

##### AC-DC channel A (B)

- Depress push-button AC-DC of channel A (B) - **S30** (**S36**)
- Check that the pulse top difference is more than 0.5 div.

##### Sampling loop gain

- Set the TIMEIDIV switch **S23** to position 0.2 ms/div.
- Depress the channel A and B ON-OFF pushbuttons **S32** and **S34** to ON.
- Apply a square wave signal of 240 mV - 2 kHz to channel A input socket **X3**.
- Set the channel B OFFSET control **R12** so that the trace is set in the middle of the screen.
- Set the TIMEIDIV switch **S23** to position 0.5 ms/div.

- Adjust potentiometer R3009 on unit A21 so that the pulse top is straight.
- Adjust potentiometer R3056 on unit A21 so that the pulse variation is symmetrical.
- Adjust potentiometer R3057 on unit A21 so that the channel B line is in the middle of the screen (if the range of R3057 is too small, change resistor R3054 (limits between 5K62 and 2K49)).
- If necessary, repeat this procedure.

### 8.3.6.2. Input attenuators (square-wave response and input capacitance)

- Set TIME/DIV switch S23 to position 20  $\mu$ s/div.
- Depress channel A (B) ON-OFF pushbutton S32 (S34) to ON.
- Release channel B (A) ON-OFF pushbutton S34 (S32) to OFF.
- Release the channel A (B) AC-DC pushbutton S30 (S36) to DC.
- Release the channel A (B) 0 pushbutton S31 (S35).
- Apply a square-wave voltage with a frequency as indicated in the table below, rise time  $\leq$  100ns to the channel A (B) input socket X3 (X4); peak to peak value as indicated in the table below.
- Check that the pulse top is straight, and pulse top errors does not exceed + or - 4%; if necessary readjust the relevant trimmers on unit A21.

2 : 1 DUMMY PROBE  
1 MHz//25 pF

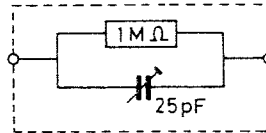

| A (B) AMPL/DIV S20 (S22) | CHANNEL A (B) INPUT SIGNAL | ADJUSTER      | TRACE HEIGHT |
|--------------------------|----------------------------|---------------|--------------|
| 20 mV/div                | 2 kHz - 24 V               | C2503 (C2427) | 6 div +/- 4% |
| 20 mV/div                | 10 kHz - 48 mV via dummy   | C dummy       | 6 div +/- 4% |
| 0.2 V/div                | 2 kHz - 240 mV             | -             | 6 div +/- 4% |
| 0.2 V/div                | 10 kHz - 480 mV via dummy  | -             | 6 div +/- 4% |
| 2 V/div                  | 2 kHz - 24 V               | C2521 (C2444) | 6 div +/- 4% |
| 2 V/div                  | 10 kHz - 48 V via dummy    | C2518 (C2442) | 6 div +/- 4% |
| 20 V/div                 | 2 kHz - 24 V               | C2484 (C2416) | 6 div +/- 4% |
| 20 V/div                 | 10 kHz - 48 V via dummy    | C2477 (C2409) | 6 div +/- 4% |

Note: The difference in input capacitance between channel A and channel B may not exceed 0.5 pF.

- Check that the range of the continuous control R7 (R8) is 1 : > 2.6
- Remove the input signal.

### 8.3.6.3. Square-wave response vertical channel

Square-wave response channel A (B) x 1

- Set TIME/DIV switch S23 to position 20 ns/div.
- Depress channel A (B) ON-OFF switch S32 (S34) to ON.
- Release channel B (A) ON-OFF switch S34 (S32) to OFF.
- Set the channel A (B) AMPL/DIV switch S20 (S22) to position 0.2 V/div 140 mV/div on the screen and in the alphanumeric display).
- Apply a square wave voltage of 240 mV - 1 MHz, risetime  $\leq$  1 ns to the channel A (B) input socket X3.
- Check the square wave response of channel A.  
Pulse top errors may not exceed 1 subdivision; if necessary, readjust R3039, C3017, C2447 and C2424, or check the square wave response of channel (B).  
Pulse top errors may not exceed 1 subdivision; if necessary, readjust C2424 and C2447 (C2496 and C2523).

Channel A square-wave response in ADD-mode

- Depress pushbutton ADD S33.
- Depress channel A ON-OFF pushbutton S32 to ON.
- Release channel B ON-OFF pushbutton S34 to OFF.
- Depress pushbutton A of the trigger source selector S39.
- Check that the square-wave response does not change when pushbutton ADD S33 is operated.

Channel B square-wave response in ADD-mode

- Release channel A ON-OFF pushbutton S32 to OFF.
- Depress channel B ON-OFF pushbutton S34 to ON.
- Depress pushbutton B of the trigger source selector S39.
- Check that the square-wave response does not change when pushbutton ADD S33 is operated.

Square-wave response channel 6-INVERT

- Depress channel B ON-OFF pushbutton S34 to ON.
- Check that the square-wave response does not change when the PULL FOR -B switch S28 is operated.
- Remove the input signal.

### 8.3.6.4. Bandwidth

- Depress channel A (B) ON-OFF pushbutton S32 (S34) to ON.
- Release channel B (A) ON-OFF pushbutton S34 (S32) to OFF.
- Set the channel A (B) AMPL/DIV switch S20 (S22) to position 10 mV/div (2 mV/div on the screen and in the alphanumeric display).
- Apply a sine-wave signal of 12 mVp-p and a frequency of 1 MHz to channel A (B) input socket X3 (X4).
- Set TIME/DIV switch S23 in such a position that about ten sine-waves are displayed on the screen (1 ms/div).
- Check that the trace height is 6 divisions.
- Increase the frequency of the input signal to 60 MHz (amplitude still 12 mVp-p).
- Set TIME/DIV switch S23 in such a position that about ten sine-waves are displayed on the screen (20 ns/div).
- Check that during the frequency range the trace height is at least 4.6 divisions.
- Remove the input signal.
- If the trace height is less than 4.6 divisions, check the square-wave response again.

### 8.3.6.5. OFFSET control range

- Set TIME/DIV switch S23 to position 0.2  $\mu$ s/div.
- Set channel A (B) AMPL/DIV switch S20 (S22) to position 0.2 V/div (40 mV/div on the screen and in the alphanumeric display).
- Apply a sine-wave signal of 1.2 Vp-p and a frequency of 2 MHz (= 30 div).
- Check that the display can be shifted more than 15 divisions on both sides by turning the channel A (B) OFFSET controls R10 (R12).
- Remove the input signal.

### 8.3.6.6. Common mode rejection

- Depress the channel A and B ON-OFF pushbuttons S32 and S34 to ON.
- Depress the channel A and B 0 pushbuttons S31 and S35.
- Set the channel A and channel B AMPL/DIV switches S20 and S22 to positions 0.2 V/div.
- Set the channel A and channel B AMPL/DIV continuous controls R7 and R8 to their CAL positions.
- Set the channel A and 6 OFFSET controls R10 and R12 so that the traces are situated in the centre of the screen.
- Release the channel A and B 0 pushbuttons S31 and S35.
- Depress pushbutton ADD S33.
- Pull PULL FOR -B switch S28.
- Apply a sine-wave signal with an amplitude of 960 mVp-p and a frequency of 2 MHz to the channel A as well as the channel B input sockets X3 and X4.
- Check that the rejection factor is better than 100. (Signal < 0.25 divisions).

## 8.3.7. Time coefficient adjustments

## 8.3.7.1. Recurrent-mode

- Depress channel A ON-OFF pushbutton S32 to ON.
- Release channel B ON-OFF pushbutton S34 to OFF.
- Turn the XMAGN control R2 in the CAL position.
- Set channel A AMPL/DIV switch S20 to position 0.2 V/div (40 mV/div on the screen and in the alphanumeric display).
- Set the TIME/DIV switch S23 to position 20 ns/div.
- Apply a time marker signal of 160mV and a pulse repetition rate of 20 ns to the channel A input socket X3.
- Check that the entire 8 cycles have a total width of 8 divisions.  
If necessary readjust potentiometer R2958 on unit A22.
- Check that the range of the variable X-magn. R2 is 1 : > 2.5.
- Depress pushbutton DOTS S16-C.
- Turn potentiometer R2911 clockwise so that a horizontal trace appears at the left-hand side of the screen.
- Now adjust R2911 on unit A22 so that the horizontal trace just disappears, i.e. the first dot of the signal starts on the most left graticule line.
- Release pushbutton DOTS S16-C.
- Check all the TIME/DIV switch S23 positions in recurrent mode.
- Remove the input signal.

## 8.3.7.2. Roll-mode

- Depress pushbutton Y x 1 S16-A.
- Depress pushbutton ROLL S38-A.
- Apply a square wave signal with a repetition rate of 0.5 s to the channel A input socket X3.
- Depress pushbutton RUN-STOP S37.
- Check the ROLL mode in TIME/DIV switch S23 position 0.5 s/div.
- Depress pushbutton CLEAR S11.
- Apply a voltage of +3 V to the external socket X6 and check that the ROLL-mode starts.
- Remove the voltage from X6.
- Depress pushbutton CLEAR S11.
- Apply a square wave signal with a repetition rate of 1 s to the channel A input socket X3.
- Depress pushbutton RUN-STOP S37.
- Check the ROLL-mode in TIME/DIV switch S23 position 1 s/div.
- Depress pushbutton CLEAR S11.
- Set the jumper S1201 on unit A12 in the left position.
- Depress pushbutton RUN-STOP S37.
- Check the ROLL-mode in TIME/DIV switch S23 position 60 min/div.
- Set the jumper S1201 on unit A12 in the correct position.
- Remove the input signal.

## 8.3.7.3. Effectivedelay

- Depress pushbutton RECURR S38-C.
- Depress pushbutton Yx5 S16-B.
- Set the TIME/DIV switch S23 to position 10 ns/div.
- Set channel A AMPL/DIV switch S20 to position 2 V/div (0.4mV/div, on the screen and in the alphanumeric display). Set the DELAY to 0000.
- Apply a square-wave voltage of about 2.4 VP-P - 100kHz and a rise time  $\leq 3$  ns to the A input socket X3
- Depress pushbutton DC of the trigger mode selector switch S29.
- Set LEVEL control R9 for a triggered display.
- Check that the effective delay is more than 1 division.

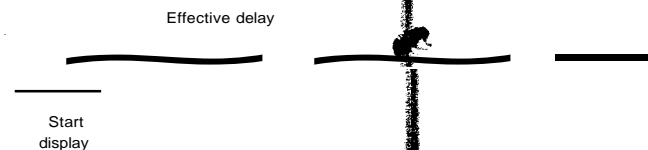

## 8.3.7.4. Single shot

- Depress pushbutton DISPLAY ACCU S1.
- Depress pushbuttons DISPLAY STO1, STO2 and STO3 (S2, S3 and S4).
- Depress pushbutton Yx1 S16-A.
- Set TIME/DIV switch S23 to position 2 ms/div.
- Depress pushbutton AC of the trigger mode selector switch S29.
- Apply a square wave voltage of 1.2 Vp-p, frequency 1 kHz to the channel A input socket X3.
- Set LEVEL control R9 for a triggered display.
- Remove the input signal.
- Depress pushbutton SINGLE S38-B and check that the pilot lamp NOT TRIG'D 823 lights up (depress RESET S37).
- Apply the square wave voltage to the channel A input socket X3 again.
- Check that the ACCU is refreshed and that the pilot lamp NOT TRIG'O 823 is extinguished.

## 8.3.7.5. Multiple

- Depress pushbutton RECURR S38-C.
- Remove the input signal.
- Depress pushbuttons ROLL and SINGLE (= MULTIPLE) S38-A and S38-B and check that the pilot lamp NOT TRIG'D 823 lights up (depress pushbutton RESET S37).
- Apply the square wave voltage to the channel A input socket X3 again.
- Check that all 4 registers are refreshed and that the pilot lamp NOT TRIG'D 823 is extinguished.
- Release pushbuttons S2, S3 and S4.
- Remove the input signal.

## 8.3.7.6. VCO

- Connect a voltmeter to test point Vcx.
- Set the TIME/DIV switch to position 0.2  $\mu$ s/div.
- Adjust C1213 for a voltmeter display of 400mV approx.
- Set the TIME/DIV switch to position 0.5  $\mu$ s/div.
- Check the voltage at test point Vcx to be 800mV approx.

## 8.3.8. Triggering

**Trigger sensitivity**

- Depress pushbutton Yx5 S16-8.
- Depress channel A ON-OFF pushbutton S32 to ON.
- Depress pushbutton AUTO of the trigger mode selector switch S29.
- Depress pushbutton RECURR S38-C.
- Set channel A AMPL/DIV switch S20 to position 0.2 V/div 140 mV/div on the screen and in the alpha numeric display).
- Set TIME/DIV switch S23 to position 0.5 ms/div.
- Depress pushbutton A of the trigger source selector switch S39.
- Set LEVEL control R9 in its mid-position.
- Apply a sine-wave signal of 20 mVp-p - 2 kHz to the channel A input socket X3.
- Adjust potentiometer R2867 on unit A22 so that a triggered display is obtained.
- Remove the input signal.

**Trigger slope and level**

- Push SLOPE switch S27 to "+".
- Apply a sine-wave signal of 240 mVp-p - 2 kHz to the channel A input socket X3.
- Check that the display is triggered on the positive going edge of the signal and that the trigger point moves upwards when the LEVEL control R9 is turned clockwise.
- Pull SLOPE switch S27 to "-".
- Check that the display is triggered on the negative going edge of the input signal.
- Push SLOPE switch S27 again to "+".
- Depress pushbutton AC of the trigger mode selector switch S29.
- Rotate the LEVEL control R9 fully clockwise and anti-clockwise and check that in both extreme positions the trace is not triggered.
- Increase the signal amplitude of the input signal to 960 mVp-p.
- Rotate the LEVEL control R9 fully clockwise and anti-clockwise and check that in both extreme positions the trace remains triggered.
- Remove the input signal.

**Trigger level AUTO**

- Depress pushbutton AUTO of the trigger mode selector switch S29.
- Apply a sine-wave signal of 240 mVp-p - 100 Hz to channel A input socket X3.
- Rotate LEVEL control R9 and check that the trigger point can be shifted over 4 divisions.
- Remove the input signal.

**Trigger level EXT**

- Depress pushbutton AC of the trigger mode selector switch S29.
- Depress pushbutton EXT of the trigger source selector switch S39.
- Apply a sine-wave signal of 240 mVp-p - 100 Hz to channel A input socket X3.
- Apply a sine-wave signal of 3.2 Vp-p - 2 kHz to EXT input socket X6.
- Rotate LEVEL control R9 and check that the trigger point can be shifted over the total signal amplitude.

**Trigger level EXT=10**

- Depress pushbutton EXT=10 of the trigger source selector switch S39.
- Apply a sine-wave signal of 32 Vp-p - 2 kHz to EXT input socket X6.
- Rotate LEVEL control R9 and check that the trigger point can be shifted over the total signal amplitude.
- Remove the input signal.

**Trigger sensitivities**

- Depress pushbutton A of the trigger source selector switch S39.
- Apply a sine-wave signal to the channel A input socket X3 according to the table below.
- Set the TIME/DIV switch S23 to such a position that about ten sine-waves are displayed on the screen.
- Set the LEVEL control R9 for a stationary display.

- Check the trigger sensitivity in accordance with the table below.

| TRIGGER MODE | INPUT FREQUENCY | AMPLITUDE |
|--------------|-----------------|-----------|
| AUTO         | 100 Hz          | 0.75 div  |
|              | 60 MHz          | 1.5 div   |
| AC           | 20 Hz           | 0.75 div  |
|              | 60 MHz          | 1.5 div   |
| DC           | 10 Hz           | 0.75 div  |
|              | 60 MHz          | 1.5 div   |
| EXT          | 40 MHz          | 0.15 V    |
|              | 60 MHz          | 0.3 V     |
| EXT ÷ 10     | 40 MHz          | 1.5 V     |
|              | 60 MHz          | 3 V       |

- Check the trigger sensitivity for EXT and EXT=10 for l.f. and h.f. signals.
- Remove the input signal.
- Depress channel B ON-OFF pushbutton S34 to ON.
- Release channel A ON-OFF pushbutton S32 to OFF.
- Set channel B AMPL/DIV switch S22 to 0.2 V/div. (40 mV/div on the screen and in the alphanumeric display).
- Depress pushbutton B of the trigger source selector switch S39.
- Apply a sine-wave signal with an amplitude of 1.5 division - 60 MHz to the channel B input socket X4.
- Check that a triggered display is obtained.
- Remove the input signal.

**Triggering at mains frequency**

- Depress channel A ON-OFF pushbutton S32 to ON.
- Release channel B ON-OFF pushbutton S34 to OFF.
- Depress pushbutton AC of the trigger mode selector switch S29.
- Set TIME/DIV switch S23 to position 2 ms/div.
- Depress pushbuttons EXT and EXT=10 of trigger source selector switch S39 simultaneously (LINE).
- Apply a mains voltage derived signal of 200 mVp-p via a transformer to the channel A input socket X3.
- Check that independent on the position of LEVEL control R9 a triggered display can be obtained.
- Remove the input signal.

**T. V. triggering**

- Depress pushbutton A of the trigger source selector switch S39.
- Depress pushbutton TVF of trigger mode selector switch S29.
- Apply a TV signal (CCIR norm - 625 lines - positive video - amplitude 0.5 division sync. pulse) to channel A input socket X3.
- Set TIME/DIV switch S23 to position 0.1 ms/div.
- Check that a triggered display is obtained with a frame pulse and an equalization pulse on the screen.
- Remove the TV signal.

**Trigger delay adjustment**

- Depress pushbutton AUTO of the trigger mode selector switch S29.
- Set TIME/DIV switch S23 to 10 ns/div.
- Set the TRIGGER DELAY alphanumeric display B21 to zero by pressing both pushbuttons UP and DIGIT S24 and S25 simultaneously (RESET).
- Apply a square-wave signal of 2 MHz, rise time  $\leq$  1 ns to channel A input socket X3.
- Check that the leading edge of the signal is visible on the screen.
- Set the number 100 in the alphanumeric display B21 with pushbuttons DIGIT and UP S25 and S24.
- Adjust potentiometer R2910 on unit A22 so that the leading edge of the signal is again visible on the screen.
- Set the number 0 in the display B21 by pressing both pushbuttons UP and DIGIT S24 and S25 simultaneously.
- Remove the input signal.

## Trigger delay

- Set TIME/DIV switch S23 to position 0.2 ms/div.
- Depress pushbutton DC of the trigger mode selector switch S29.
- Set the number 0002 in the alphanumeric display B21 with pushbuttons DIGIT and UP S25 and S24 and set pushbutton DIGIT S25 to the least significant DIGIT (= 2).
- Apply a square-wave voltage of 2 kHz to the channel A input socket X3.
- Set LEVEL control R9 for a triggered display.
- Set TIME/DIV switch S23 step by step to position 0.5  $\mu$ s/div. and check at each position that the beginning of the signal can be shifted in the screen by using pushbutton UP S24.
- Set the TIME/DIV switch S23 to position 0.2  $\mu$ s/div and check that the number in the alphanumeric display B21 is 100 (max. value in sampling mode-"repetitive only").

## 8.3.9. X-Y mode

- Depress the channel A and B ON-OFF pushbuttons S32 and S34 to ON.
- Depress the channel A and B pushbuttons "0" S31 and S35.
- Set the channel A and B AMPL/DIV switch S20 and S22 to 0.2 V/div.
- Set TIME/DIV switch S23 to position 0.5  $\mu$ s/div.
- Set the channel A and B OFFSET controls R10 and R12 so that the spot is shifted to the centre of the screen.
- Release the channel A and B pushbuttons "0" S31 and S35.
- Depress pushbutton X = A N = B S15-B.
- Apply a sine wave signal of 240 mVp-p - 2 MHz to the channel A as well as the channel B input sockets X3 and X4.
- Check that a straight line is displayed with an angle of 45° with the positive horizontal axis.
- Check the same with TIME/DIV switch S23 in position 0.2  $\mu$ s/div.
- Depress the channel A "0" pushbutton S31.
- Check that a vertical line is displayed.
- Remove the input signals.

## 8.3.10. Range indication

- Depress pushbutton X = t S15-A.
- Depress channel A (B) ON-OFF pushbutton S32 (S34) to ON.
- Release channel B (A) ON-OFF pushbutton S34 (S32) to OFF.
- Read the A (B) V/div. alphanumeric display B10 (B11) contents.
- Connect a probe with range indication to the channel A (B) input socket X3 (X4).
- Check that the indication in the A (B) V/div. alphanumeric display B10 (B11) is changed by a factor of 10.

## 8.3.11. Plotter outputs

- Store a square-wave signal of 1 div. in memory STO1.
- Select memory STO1 with SELECT pushbutton S14.
- Connect *voltmeters* to the plotter output sockets on the rear side of the instrument
- Depress pushbutton PLOT S18 and check the following:
  1. X-OUT and Y-OUT are 0 Volt
  2. PENLIFT goes to 0 Volt
  3. X-OUT and Y-OUT are generating output signals
- Check that during plotting an intensified dot is visible on the screen.
- Depress pushbutton PLOT S18 again and check that the PLOT action is stopped.
- Remove the input signal.

## 8.3.12. Periodic and random deviations

These must be checked only with the cabinet plates fitted:

- Depress pushbutton RECURR S38-C.
- Set TIME/DIV switch S23 to position 1 ms/div.
- Depress channel A (B) ON-OFF pushbutton S32 (S34) to ON.
- Depress channel B (A) ON-OFF pushbutton S34 (S32) to OFF.
- Release the channel A and B pushbuttons "0" S31 and S35.
- Depress pushbuttons AC/DC of the input coupling controls S30 and S36 to AC.
- Set both AMPL/DIV switches S20 and S22 to positions 10 mV/div and the AMPL/DIV continuous controls R7 and R8 to their CAL positions.
- Depress pushbutton AUTO of the trigger mode switch S29.
- Check that ripple-noise-instability of the trace and microphony does not exceed 4 mm.

## 8.3.13. Effect of mains voltage variations

- Depress channel A ON-OFF pushbutton S32 to ON.
- Depress channel B ON-OFF pushbutton S34 to ON.
- Set channel A AMPL/DIV switch S20 to position 1 V/div.
- Set channel B AMPL/DIV switch S22 to position 1 V/div.
- Connect the CAL terminal x1 output signal with the channel A as well as the channel B input sockets X3 and X4.
- Vary the mains voltage by + and - 10%.
- Check that neither trace height nor trace width changes and that the brilliance remains the same.

8.4. ADJUSTMENT INTERACTIONS

Adjustment

- Power supply
- C.R.T. circuit
- Balance adjustments vertical amplifier
- Trigger balance AC-DC
- Trigger amplifier balance
- Trigger point symmetry
- Final amplifier adjustments
- Vertical amplifier sensitivities
- P<sup>2</sup>CCD adjustments
- Input attenuators
- Square-wave response vertical channel
- Time coefficients
- Trigger sensitivity
- Trigger delay

- Interaction
- Power supply
- C.R.T. circuit
- Balance adjustment vertical amplifier
- Trigger balance AC-DC
- Trigger amplifier balance
- Trigger point symmetry
- Final amplifier adjustments
- Vertical amplifier sensitivities
- P<sup>2</sup>CCD adjustments
- Input attenuators
- Square-wave response vertical channel
- Time coefficients
- Trigger sensitivity
- Trigger delay

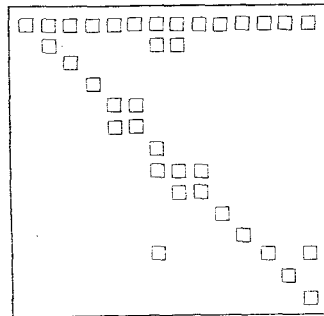

8.5. PERFORMANCE CHECK

8.5.1. General information

**WARNING:** Before switching on, ensure that the oscilloscope has been installed in accordance with the instructions outlined in chapter 2 of the operating manual. Installation Instructions.

This procedure is intended to be used for incoming inspection to determine the acceptability of newly purchased or recently recalibrated instruments.

It does not check every facet of the instrument's calibration; rather it is concerned primarily with those portions of the instrument which are essential to measurement accuracy and correct operation. Removing the instrument covers is not necessary to perform this procedure. All checks are made from the front panel.

If this test is started a few minutes after switching on, bear in mind that test steps may be out of specification, due to insufficient warming-up time. To avoid this situation, allow the specified warming-up time.

The performance checks are made with a stable, well-focused, low intensity display. Unless otherwise noted, adjust the intensity and trigger-level controls as needed.

- Note 1: At the start of every check, the controls always occupy the preliminary settings; unless otherwise stated.
- Note 2: The input voltage has to be supplied to the A-input; unless otherwise stated.
- Note 3: Set the TIME/DIV switch to a suitable position; unless otherwise stated.

8.5.2. Preliminary settings of the controls

- Start this check procedure with **NO** input signals connected. ALL pushbuttons released and ALL switches in the CAL position.
- Depress the controls as indicated in figure below.

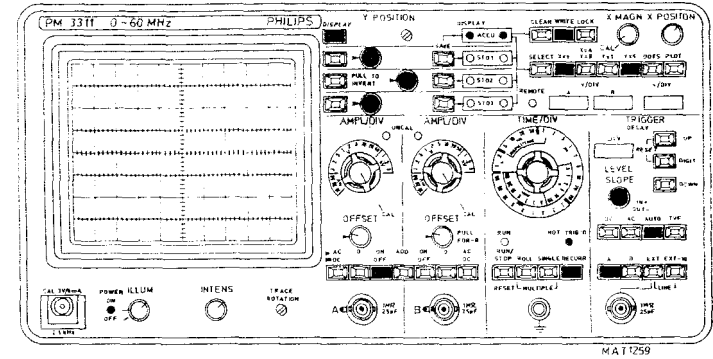

MA T 1259



## 8.5.3. Recommended test equipment



| Type of instrument                              | Specifications  | Example of recommended instrument  |
|---|---|--|
| Constant amplitude sine-wave generator          | Freq. 200kHz ... 60MHz<br>Constant amplitude of 12mVp-p ... 1.2Vp-p   | Tektronix SG503 + SG504  |
| Time marker generator                           | Repetition rate 0.5s ... 20ns<br>Rise time $\leq$ 200ns<br>Voltage 10mV up to (for preference) 30V.   | Tektronix TG501<br>Generator with additional attenuator unit, Partly PG506 |
| Square-wave calibration generator               | Duty cycle 50%<br>Rise time $\leq$ 1nsec.<br>Sine-wave: 1Hz ... 1MHz/0 ... 30V<br>Square-wave: 1Hz ... 1MHz/0 ... 30V<br>Rise time $\leq$ 100ns   | PM5129   |
| L.F. sine-wave/square-wave generator            | General Radio types for fast rise-time square-wave and high frequency sine-wave.<br>BNC-types for other applications.<br>1M $\Omega$ $\pm$ 0.1% // 25pF<br>Well-insulated output voltage 90 ... 25kV a.c. | PHILIPS' ord. number 2422 529 00005  |
| Cables, T-piece, terminators for the generators |   |  |
| Dummy probe 2 : 1                               |   |  |
| Variable mains transformer                      |   |  |
| Mouthington meter                               |   |  |

## CHECKING PROCEDURE



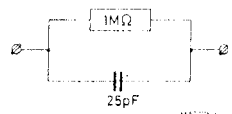

| STEP      | OBJECTIVE                       | INPUT VOLTAGE  | SETTINGS   | REQUIREMENTS  | MEASURING RESULTS |
|-----------|---------------------------------|--|--|---|-------------------|
| <b>A.</b> | <b>POWER ON &amp; DISPLAY</b>   |  |  |   |                   |
| A.1.      | Start power on                  |  | Set the power on/off switch to ON  | Starts at 180 V (Q-version: at 90 V)<br>Pilot lamp POWER ON lights up   |                   |
| A.2.      | Current consumption             |  |  | 600 mA max. at 110 V<br>300 mA max. at 220 V  |                   |
| A.3.      | Illumination<br>Intens<br>Focus |  | Illumination potentiometer<br>Intens potentiometer<br>Intens potentiometer   | Normal brightness adjusting<br>Normal intens adjusting<br>Automatic focus adjusting   |                   |
| A.4.      | Trace rotation                  |  |  | Line must be in parallel with horizontal graticule lines, if necessary, readjust potentiometer.<br>TRACE ROTATION   |                   |
| <b>B.</b> | <b>VERTICAL SELECTIONS</b>      |  |  |   |                   |
| B.1.      | Channel control A (B)           |  | Depress pushbutton ON of ch. A (ch. B)   | Trace channel A (B) is visible on the screen  |                   |
| B.2.      | ODC AC control A (B)            | Sine-wave signal, 2 kHz $\pm$ DC offset to ch. A (ch. B) | Depress pushbutton O of ch. A (ch. B)<br>Release pushbutton O of ch. A (ch. B)<br>Depress pushbutton AC of ch. A (ch. B)<br><br>Release pushbutton AC of ch. A (ch. B); ey. DC | Adjust the sine-wave amplitude so that the trace height is ca. 4 div<br><br>Set the trace in the centre of the screen<br><br>Signal is visible on the screen, centre of the sine-wave is on the centre of the screen<br><br>Signal is visible on the screen, centre of the sine-wave is on DC-offset level. |                   |
| 8.3.      | ADD                             | Sine-wave signal, 2 kHz to ch. A and ch. B               | Depress pushbutton ADD   | Signal amplitude is the adding of ch. A $\pm$ ch. B   |                   |

CHECKING PROCEDURE

| STEP | OBJECTIVE                       | INPUT VOLTAGE  | SETTINGS  | REQUIREMENTS   | MEASURING RESULTS |
|------|---------------------------------|--|---|--|-------------------|
| A    | POWER ON + DISPLAY              |  |   |  |                   |
| A.1  | Start power on                  |  | Set the power on/off switch to ON   | Starts at 180 V (1 version: at 90 V)<br>Pilot lamp POWER ON lights up  |                   |
| A.2  | Current consumption             |  |   | 300 mA max. at 110 V<br>300 mA max. at 220 V   |                   |
| A.3  | Illumination<br>Intens<br>Focus |  | Illumination potentiometer<br>Intens potentiometer<br>Intens potentiometer  | Normal brightness adjusting<br>Normal intens adjusting<br>Automatic focus adjusting  |                   |
| A.4  | Trace rotation                  |  |   | Line must be in parallel with horizontal graticule lines; if necessary, readjust potentiometer<br>TRACE ROTATION   |                   |
| 8.   | VERTICAL SELECTIONS             |  |   |  |                   |
| B.1. | Channel control A (B)           |  | Depress pushbutton ON of ch. A (ch. B)  | Trace channel A (B) is visible on the screen   |                   |
| 8.2. | O-DC-AC control A (B)           | Sine-wave signal, 2 kHz + DC offset to ch. A (ch. B)   | Depress pushbutton O of ch. A (ch. B)<br>Release pushbutton O of ch. A (ch. B)<br>Depress pushbutton AC of ch. A (ch. B)<br>Release pushbutton AC of ch. A (ch. B); eg DC | Adjust the sine-wave amplitude so that the trace height is ca. 4 div.<br><br>Set the trace in the centre of the screen<br><br>Signal is visible on the screen, centre of the sine-wave is on the centre of the screen<br><br>Signal is visible on the screen, centre of the sine-wave is on DC-offset level. |                   |
| B.3. | ADD                             | Sine-wave signal, 2 kHz to ch. A and ch. B   | Depress pushbutton ADD  | signal amplitude is the adding of ch. A + ch. B  |                   |
| 8.4. | Vertical trace height           | Sine wave signal 480 mVp-p 2 kHz   | Ampl /Div. switch = 0.2 V/div<br>Depress Display ACCU; STO 1, STO 2 and STO 3<br>Depress SAVE STO 1; STO 2 and STO 3<br>Depress pushbutton Yx1                            | Max. signal amplitude = 2 div. all 4 signals are blinking at upper and lower-top   |                   |
| B.5. | Invert stores                   | As B 4   | As. B 4.<br>Pull the INVERT switches of STO 1, STO 2 and STO 3  | Display of STO 1, STO 2 and STO 3 is inverted  |                   |
| B.6. | Dot join                        | Aa B 4   | As. B 4<br>Depress pushbutton DOTS  | Signals are built up by dots   |                   |
| C.   | VERTICAL CHANNELS               |  |   |  |                   |
| C.1. | Vertical gain A (B)             | Square-wave signal 240 mVp-p 2 kHz to ch. A (ch. B)  | AMPL/DIV switch = 0.2 V/div<br>Depress pushbutton Yx1<br>Depress pushbutton Yx5   | Trace height = 1.2 div. ± 3% (± 0.2 subdiv.)<br>Trace height = 6 div. ± 5% (± 1.5 subdiv.)   |                   |
| C.2. | AMPL/DIV position               | Square-wave signal, freq. 2 kHz to ch. A (ch. B)<br><br>Ampl: 12 mV p-p<br>24 " "<br>60 " "<br>120 " "<br>240 " "<br>600 " "<br>1.2 Vp-p<br>2.4 " "<br>6 " "<br>12 " "<br>24 " "<br>60 " " | AMPL/DIV switch position:<br><br>10 mV/div.<br>20 " "<br>50 " "<br>0,1 V/div.<br>0.2 " "<br>0,5 " "<br>1 " "<br>2 " "<br>5 " "<br>10 " "<br>20 " "<br>50 " "              | Trace height = 6 div. ± 5% (± 1.5 subdiv.)   |                   |

| STEP | OBJECTIVE   | INPUT VOLTAGE  | SETTINGS   | REQUIREMENTS   | MEASURING RESULTS |
|------|---|--|--|--|-------------------|
| C.3  | Continue range A (B)  | Square-wave signal<br>240 mV - 100 Hz<br>to ch. A (ch. B)                        | Continue potentiometer    | Continue range 1: >2,5<br>Pilot lamp "UNCAL" lights up   |                   |
| C.4. | Vertical deflection<br>A (B) via dummy  | Square wave signal<br>freq. 10 kHz to<br>ch. A (ch. B)                           | AMPL/DIV switch position:  |  |                   |
|      |  | Ampl. 48 mVp-p<br>480 " " " " " "<br>4,8 Vp-p<br>48 " " " " " "                  | 20 mV/div<br>0,2 V/div.<br>2 " "<br>20 " "   | Trace height = 6 div. ± 5%<br>(± 1.5 subdiv.)  |                   |
| C.5. | Square-wave response<br>(A, B and -B)   | Square-wave signal<br>240 mVp-p, 1 MHz<br>risetime ≤ 1 nsec.<br>to ch. A (ch. B) | AMPL/DIV switch = 0,2 V/div.<br>(for -B: pull the PULL<br>FOR - B switch)  | Pulse aberrations ± 3%,<br>risetime ≤ 6 nsec.  |                   |
| C.6. | Visible signal delay  | As C.5.  | AMPL/DIV switch = 0,2 V/div.<br>TIME/DIV switch = 10 ns/div.   | Visible signal delay > 10 nsec.<br>NOTE: remember the value for<br>point E.7                   |                   |
| C.7. | Bandwidth A (B)   | Sine-wave signal to<br>ch. A (ch. B)<br>1 MHz                                    |  | Adjust the sine-wave amplitude<br>so that the trace height = 6 div.<br>Trace height ≥ 4.2 div. |                   |
| C.8. | Offset control range A (B)  | Sine-wave signal<br>1.2 Vp-p, 2 MHz<br>to ch. A (ch. B)                          | AMPL/DIV switch = 0,2 V/div<br>OFFSET control of ch. A<br>(ch. B)  or  | Sine-wave signal out of<br>the screen  |                   |
| C.9. | Common mode rejection<br>A and -B   | Sine-wave signal<br>960 mVp-p, 2 MHz<br>to ch. A and ch. B                       | AMPL/DIV switch = 0,2 V/div<br>Depress push-button ADD<br>Pull the PULL FOR - B<br>switch  | Rejection > 100 (signal < 0,25 div)  |                   |

| STEP | OBJECTIVE                        | INPUT VOLTAGE  | SETTINGS  | REQUIREMENTS   | MEASURING RESULTS |
|------|----------------------------------|--|---|--|-------------------|
| D.   | TIME BASE                        |  |   |  |                   |
| D.1  | Time coefficients<br>- Recurrent | Square wave signal to ch. A<br>Repetition time:<br>5 nsec<br>10 nsec<br>20 nsec<br>50 nsec<br>0.1 psec<br>0.2 psec<br>0.5 psec<br>1 psec<br>2 μsec<br>5 psec<br>10 psec<br>20 psec<br>50 psec<br>0.1 msec<br>0.2 msec<br>0.5 msec<br>1 msec<br>2 msec<br>5 msec<br>10 msec<br>20 msec<br>50 msec<br>0.1 sec<br>0.2 sec | TIME/DIV switch position.<br>5 nsec/div.<br>10 nsec/div.<br>20 nsec/div.<br>50 nsec/div.<br>0.1 psec/div.<br>0.2 psec/div.<br>1.5 psec/div.<br>1 psec/div.<br>2 psec/div.<br>5 psec/div.<br>10 psec/div.<br>20 μsec/div.<br>50 μsec/div.<br>0.1 msec/div.<br>1.2 msec/div.<br>0.5 msec/div.<br>1 msec/div.<br>2 msec/div.<br>5 msec/div.<br>10 msec/div.<br>20 msec/div.<br>50 msec/div.<br>3.1 s/div.<br>0.2 s/div | Coefficient error ± 2% (c.i. 0.2 div. over 10 div. screenwidth)<br>(Combined with magnifier: coefficient error ± 4%)                                 |                   |
|      | - Roll                           | 0.5 sec<br>1 sec<br>2 sec<br>5 sec<br>10 sec<br>20 sec<br>0.5 min( 30 sec)<br>1 min( 60 sec)<br>2 min( 120 sec)<br>6 min( 360 sec)<br>15 min( 900 sec)<br>30 min(1800 sec)<br>60 min(3600 sec)   | Depress pushbutton ROLL.<br>Start every action with RUN<br>0.5 s/div.<br>1 s/div.<br>2 s/div.<br>5 s/div.<br>10 s/div.<br>20 s/div.<br>0.5 min/div.<br>1 min/div.<br>2 min/div.<br>6 min/div.<br>15 min/div.<br>30 min/div.<br>60 min/div.  | Coefficient error ± 2% (c.i. 0.2 div. over 10 div. screenwidth)<br>During action pilot lamp "RUN" lights up<br>After action pilot lamp "RUN" flashes |                   |
| D.2. | Variable X-magn. range           | Square-wave signal to ch. A<br>repetition time<br>10 msec  | TIME/DIV switch position<br>1 ms/div.   | X-magnifier range = $1 \geq 2.5$   |                   |
| D.3. | Single shot                      | Square-wave signal 1 kHz to ch. A  | TIME/DIV switch position<br>1 ms/div.<br>Depress pushbutton SINGLE<br>Depress pushbutton Y x 1<br>Start every action with RUN   | ACCU is refreshed and during the single shot action the pilot lamp "NOT TRIG'D" lights up  |                   |
| D.4. | Multiple                         | As D.3.  | TIME/DIV switch position<br>1 ms/div.<br>Depress pushbuttons ROLL, and SINGLE (c.i. MULTIPLE)<br>Depress Display ACCU;<br>STO 1; STO 2 and STO 3<br>Depress pushbutton Y x 1<br>Start every action with RUN   | ACCU, STO 1, STO 2 and STO 3 are refreshed and during the Multiple action the pilot lamp "NOT TRIG'D" lights up                                      |                   |

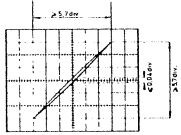
| STEP | OBJECTIVE                            | INPUT VOLTAGE   | SETTINGS   | REQUIREMENTS   | MEASURING RESULTS |
|------|--------------------------------------|---|--|--|-------------------|
| E.   | TRIGGERING                           |   |  | (NOTE: If signal triggers the pilot lamp "NOT TRIG'D" is extinguished)   |                   |
| E.1. | Sensitivity A (B)                    | Sine-wave signal to ch. A (ch. B) frequency<br>100 Hz<br>20 Hz<br>10 Hz<br>40 MHz<br>60 MHz                               | Depress pushbutton A (B)<br><br>Depress pushbutton AUTO<br>Depress pushbutton AC<br>Depress pushbutton DC  | Signal triggers at 0,75 div.<br>Signal triggers at 0,75 div.<br>Signal triggers at 0,75 div.<br>Signal triggers at 0,75 div.<br>Signal triggers at 1,5 div.  |                   |
| E.2. | Sensitivity EXT<br><br>EXT $\neq$ 10 | Sine-wave signal to EXT frequentie<br>40 MHz<br>60 MHz<br>40 MHz<br>60 MHz  | Depress pushbutton EXT<br><br>Depress pushbutton DC<br><br>Depress pushbutton EXT $\neq$ 10  | Signal triggers at 0,15 Vp-p<br>Signal triggers at 0,3 Vp-p<br>Signal triggers at 1,5 Vp-p<br>Signal triggers at 3 Vp-p  |                   |
| E.3. | Slope                                | Sine-wave signal<br>240 mVp-p,<br>2 kHz to ch. A  | AMPL/DIV switch = 0,2 V/div.<br><br>Pull the SLOPE switch  | Signal triggers on positive going edge<br><br>Signal triggers on negative going edge   |                   |
| E.4. | Level range                          | As E.3.   | LEVEL control <br><br>Depress pushbutton AC<br>LEVEL control <br><br>Depress pushbutton DC<br>LEVEL control <br><br>LEVEL control <br><br>Increase the sine-wave signal to 1,2 Vp-p, 2 kHz | Trace is triggered in the most extreme positions of the LEVEL control<br><br>Trace is not triggered in the most extreme positions of the LEVEL control<br><br>Trace is not triggered in the most extreme positions of the LEVEL control<br><br>Trace is triggered in the most extreme positions of the LEVEL control |                   |
| E.5. | T.V. triggering                      | T.V. signal according to C.C.I.R. (625 lines), ampl. sync pulse = 0,5 div.p-p   | Depress pushbutton TVF   | Signal triggers  |                   |
| E.6. | Display range trigger delay          |   | If necessary, depress pushbutton UP, DOWN or DIGIT<br>TIME/DIV switch = 1 ms/div.<br>TIME/DIV switch = 0,2 $\mu$ s/div.  | Display range is -9 ... 9999 div.<br>Display range is 0 ... 100 div.   |                   |
| E.7. | Accuracy trigger delay               | Square-wave signal, repetition time = 0,1 msec to ch. A<br><br>Square-wave signal, repetition time = 1 $\mu$ sec to ch. A | TIME/DIV switch = 20 $\mu$ s/div.<br>Trigger delay = 0000<br>Trigger delay = 1900<br>Trigger delay = 9999<br><br>TIME/DIV switch = 0,2 $\mu$ s/div.<br>Trigger delay = 0000<br>Trigger delay = 0100  | Accuracy = 0<br>Accuracy = $\pm$ 2 mm (1 subdiv.)<br>Accuracy = 0,01% (for 9999 : 1 div.)<br>NOTE: Wait for a trigger pulse!<br><br>Accuracy = 0<br>Accuracy = $\pm$ 2 div. + visible delay (for visible delay, see point C.7.)  |                   |
| F.   | X-Y Mode                             | Sine-wave signal, 240 mVp-p, 2 MHz to ch. A and ch. B   | Depress pushbutton ON of ch. A and ch. B<br>Depress pushbutton X=A, Y=B<br>Set the ch. A and ch. B AMPL/DIV switches to 0,2 V/div.   | - A line is visible with an angle of 45 $^{\circ}$ with the horizontal axis<br>- Amplitude of X-defl. and Y-defl. is $\geq$ 5,7 div.<br>- Distance between lines in centre of signal $\approx$ 0,04 div.<br>                     |                   |
| G.   | Plotter outputs                      | Sine-wave voltage, 480 mVp-p, 2 kHz to ch. A  | AMPL/DIV switch = 0,2 V/div.<br>Depress pushbutton PLOT  | - Check that the plot action starts by depressing pushbutton PLOT<br>- Plottime $\approx$ 100 sec<br>- During plot:<br>penlift = 100 V<br>X-out = 1 V max.<br>Y-out = 1 V max.<br>intensified dot is visible on the screen   |                   |
| H.   | Calibration                          |   |  | Calibration voltage = 3 Vp-p<br>Calibration frequency = 2,5 kHz  |                   |

## 9. CORRECTIVE MAINTENANCE

### 9.1. REPLACEMENTS

**WARNING:** The opening of covers or removal of parts, except those to which access can be gained by hand, is likely to expose live parts, and also accessible terminals may be live. The instrument shall be disconnected from all voltage sources before any adjustment, replacement or maintenance and repair during which the instrument will be opened. If afterwards any adjustment, maintenance or repair of the opened instrument under voltage is inevitable, it shall be carried out only by a qualified person who is aware of the hazard involved. Bear in mind that capacitors inside the instrument may still be charged even if the instrument has been separated from all voltage sources.

#### Standard parts

Electrical and mechanical replacement parts can be obtained through your local Philips organisation or representative. However, many of the standard electronic components can be obtained from other local suppliers.

Before purchasing or ordering replacement parts, check the parts list for value tolerance, rating and description

**Note:** Physical size and shape of a component may affect instrument performance, particularly at high frequencies. Always use direct-replacement components, unless it is known that a substitute will not degrade instrument performance.

#### Special parts

In addition to the standard electronic components, some special components are used. These components are manufactured or selected by Philips to meet specific performance requirements

#### Transistors and integrated circuits

Transistors and I.C.'s (integrated circuits) should not be replaced unless they are actually defective. If removed from their sockets during routine maintenance return them to their original sockets. Unnecessary replacement or switching of semiconductor devices may affect the calibration of the instrument. When a transistor is replaced, check the operation of the part of the instrument that may be affected. (see interaction table 8.4.)

**WARNING:** Handle silicone grease with care. Avoid getting silicone grease in the eyes. Wash hands thoroughly after use.

Any replacement component should be of the original type or a direct replacement. Bend the leads to fit the socket and cut the leads to the same length as on the component being replaced.

#### 9.1.1. Replacing single knobs

- Prise off cap A.
- Slacken screw (or nut) B.
- Pull the knob from the spindle.

When fitting a knob or cap, ensure that the spindle is in a position which allows reference lines to be coincident with the markings on the text plate of the oscilloscope.

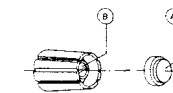

MAT 153

#### 9.1.2. Replacing double knobs

- Prise off cap A and slacken screw B.
- Pull the inner knob from the spindle.
- Slacken nut C and pull the outer knob from the spindle.

When fitting a knob or cap, ensure that the spindle is in a position which allows reference lines to be coincident with the markings on the text plate of the oscilloscope.

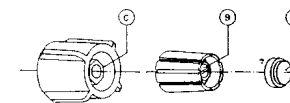

MAT 163

### 9.1.3. Replacing carrying handle

1. Remove both the upper and lower cabinet plates after slackening the four quick-release fasteners at the corners of each plate. To prevent the fasteners coming apart, do not slacken more than two turns.
2. Remove the plastic strip which is snapped on to the grip.
3. Remove the four screws which secure the grip to the brackets (these screws have been locked with a sealing varnish).
4. Depress the push-buttons in the brackets and turn the carrying handle as far as possible to the upper side of the oscilloscope.
5. Keep the push-button of the right-hand bracket depressed and pull the bracket from its bearing 1).
6. Remove the grip from the remaining bracket.
7. Depress the push-button of the left-hand bracket and turn the latter as far as possible to the lower side of the instrument.
8. Keep the push-button depressed and pull the bracket from its bearing.

If it is impossible to remove the left-hand bracket in this way, remove also its bearing in a similar way as described in footnote 1).

1) With some instruments it may be impossible to remove the handle in the described way. This is due to an extra securing plate in the right-hand bearing. In that case, DO NOT USE FORCE, but work in accordance with the following procedure which replaces points 3, 4 and 5.

3. Remove the two screws which secure the grip to the right-hand bracket.
4. Remove the two hexagonal bolts which secure the right-hand bearing to the side strip.
5. Depress the push-button of the right-hand bracket and take the bearing from the bracket.

### 9.1.4. Removing the cabinet plates and the screen bezel

Both upper and lower cabinet plate can be removed after slackening one or two turns the four quick release fasteners at the corners of each plate. Do not slacken the fasteners more than two turns, otherwise they may come apart.

The screen bezel can be detached by pressing the longer edges and pulling out.

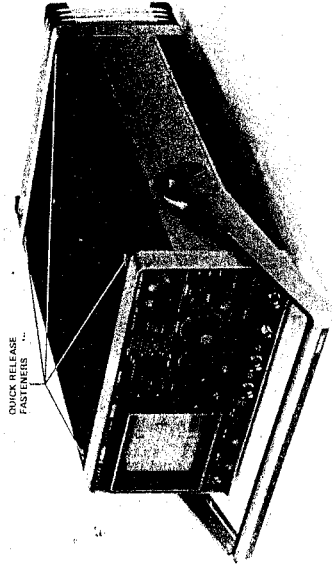

Fig. 9.1.1.

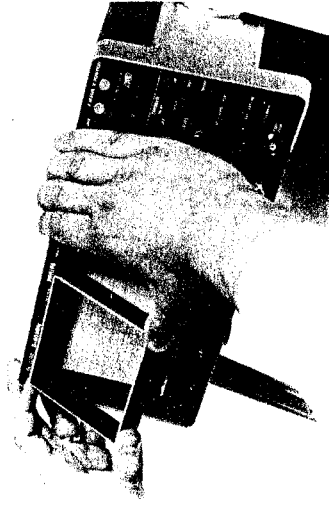

Fig. 9.1.2.

9-4

## 9.1.5. Replacing the plug-in units

The plug-in units are:

- A4 – microprocessor unit
- A6 – RAM unit
- A7 – buffer unit
- A8 – conversion unit
- A9 – ACL unit
- A10 – CCD logic unit
- A12 – time-base unit
- A13 – delay trigger unit
- A14 – IEC bus interface (if available)
- A20 – final amplifier unit

These circuit boards can be easily removed after disconnecting the various cables. Unit A10 can only be removed after slackening the screw at the upper right side of the unit which secures the heatsinks to the metal support.

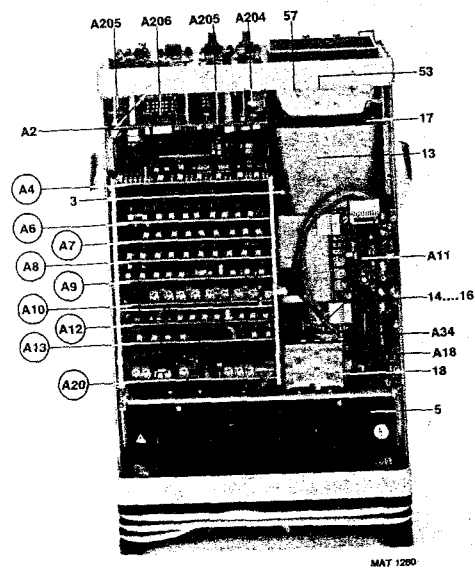

Fig. 9.1.3.

9.1.6. Replacing the P<sup>2</sup>CCD unit A11

This unit A11 is located at the upper left side of the instrument above the C.R.T

- Remove the four miniature coaxial plugs from unit A10.
- Remove the multipole connector from unit A10.
- Remove the two miniature coaxial plugs from unit A11.
- The unit can be removed after unscrewing the two screws which secure the unit to the side frame

**ATTENTION:** The P<sup>2</sup>CCD is a highly sensitive MOS circuit. Upon delivery of a spare unit the miniature coaxial plugs are interconnected so that no static charge can influence the circuit. Moreover the multipole connector is short circuited by a conductive plastic foam material. When mounting a new unit, first secure the unit mechanically to the side frame. After having taken the precautions as described in chapter 9.3, remove the conductive plastic foam of the multipole connector and plug it in the CCD logic unit. After that, the miniature coaxial connectors may be disconnected and connected to the right connectors one by one.

## 9.1.7. Replacing the front unit A2

- Remove the screen bezel and the contrast plate.
- Remove all the knobs except the pushbutton knobs.
- Remove the textplate with the two screws underneath the channel A AMPL/DIV switch and the TIME/DIV switch.
- Remove the four screws as indicated in the figure.

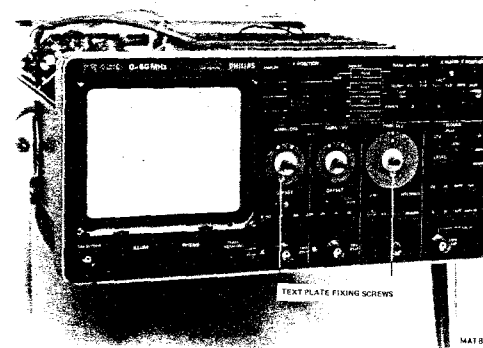

Fig. 9.1.4.

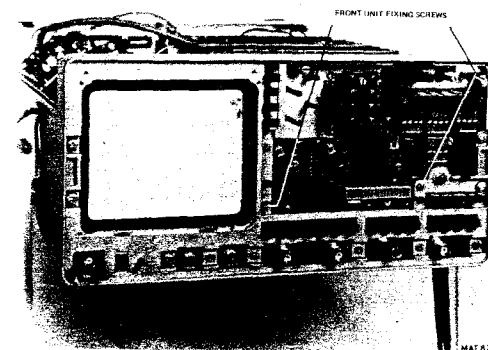

Fig. 9.1.5.



- Remove plug in unit A4.
- Disconnect the two multipole connectors on the motherboard unit A3 which are situated behind the front unit.
- Press the front unit to the rear by pushing the connector which is mounted underneath the TIME/DIV switch.
- Carefully remove the unit out of the instrument.
- When mounting again, carefully insert the front unit into the instrument.
- Be sure that the bottom of the unit is completely outlined with the connector on the motherboard.
- Carefully press the front unit into the connector.
- Fix the unit, the textplate and the knobs again in the reversed sequence.
- Plug in the microprocessor unit A4.
- Plug in the two multipole connectors.

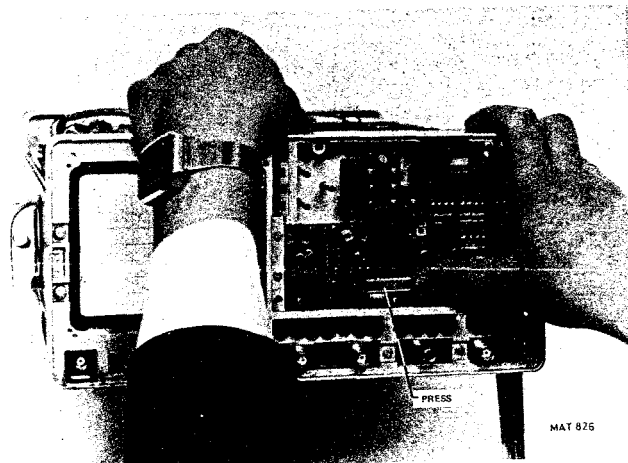

Fig. 9.1.6.

## 9.1.8. Replacing the LEVEL control.

- Remove the front unit A2.
- Unsolder the wires on the potentiometer.
- Unscrew the potentiometer.

## 9.1.9. Replacing the trigger mode selector switch

- Remove the front unit A2.
- Unsolder the interconnection wire between the LEVEL potentiometer and the switch.
- Remove the two slot headed screws on the front that fixes the switch.

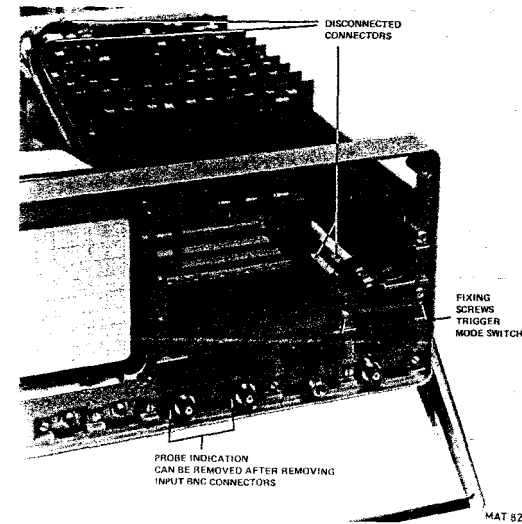

Fig. 9.1.7.

## 9.1.10. Replacing the C.R.T.

**WARNING:** Handle the C.R.T. carefully. Rough handling or scratching can cause the C.R.T. to implode.

- Remove the upper and lower instrument cabinet plate.
- Remove the bezel and the contrast plate.
- Remove the two screws that secure the upper scale illumination lamps support to the front panel and remove this support.
- Disconnect the two connectors on the C.R.T. socket from the power supply unit (A151 and the final amplifier unit (A20).
- Unsolder the red and yellow TRACE ROTATION wire from the support in the front underneath the C.R.T.
- Loosen the screw of the clamping bracket around the C.R.T. neck (accessible via the hole in the C.R.T. screen).
- Carefully withdraw the C.R.T. partly through the front panel of the instrument.
- Disconnect the EHT cable from the C.R.T. and discharge the cable and the C.R.T.
- Remove the C.R.T. and take care of the C.R.T. socket wiring.
- Remount the new C.R.T. in the reversed sequence.
- If the rubber sleeve around the neck of the C.R.T. must be slid over the neck of a replacement tube, the use of industrial talcum powder is strongly recommended, to prevent the rubber sleeve from sticking on the C.R.T. neck.

## 9.1.11. Replacing the DELAY LINE UNIT A18

The delay line can be removed after removing the C.R.T. (see section 9.1.10.).

- Remove the C.R.T.
  - Disconnect the delay line connections from the vertical amplifier unit (A21) by removing two screws and pulling four miniature plugs.
- The delay line unit itself can be removed by removing the screw of its support bracket which is visible after the C.R.T. is removed.

## 9.1.12. Removing the rear plate together with the AC POWER UNIT A16

- Remove the six slot headed screws which secure the rear panel.
- Pull out the rear panel.
- Disconnect the three cables and the miniature coaxial plug.
- Unscrew the six screws that secure the unit to the rear panel.

## 9.1.13. Removing the DC POWER UNIT A15

- Remove the rear panel.
- Remove the internal upper and lower black metal screening plates (2 screws each).
- Disconnect all the seven multipole connectors.
- Unsolder the EHT unit cable and discharge the cable.
- Remove the unit after unscrewing the seven screws that secure the unit to the chassis

## 9.1.14. Removing the mains filter

- Remove the rear panel.
- Remove the internal lower black metal screening plate (2 screws).
- Remove the screw that secures the mains filter to the chassis.

## 9.1.15. Removing the EHT unit A23

- Remove the rear panel.
- Unsolder the EHT unit cable.
- Remove the C.R.T. partly and disconnect and discharge the EHT cable.
- Remove the EHT unit after unscrewing the two ALLEN-screws that fix the unit to the chassis.

## 9.1.16. Removing the vertical amplifier unit A21

- Remove the three multipole connectors.
- Remove the screening plate from the unit.
- Remove the eight miniature coaxial sockets.
- Remove the delay line connections (see 9.1.11).
- Unsolder the two groups of connections to the trigger unit A22.
- Disconnect the wires which connect the unit to the input sockets A and B and unscrew the screws that secure the unit to these sockets.
- Remove the front panel POWER ON/OFF knob and the plastic axis which is connected to the switch and potentiometer at the rear of the Instrument.
- Remove the textplate
- Remove the complete unit after unscrewing twelve screws.

## 9.1.17. Removing trigger unit A22

- Disconnect all the three multipole connectors from the unit.
- Disconnect the five miniature coaxial plugs from the unit.
- Unsolder the wires that connect the front panel input socket EXT to the unit.
- Unsolder the two groups of connections between this trigger unit and amplifier unit A20
- Remove the textplate
- The unit can be removed now after unscrewing five screws.

## 9.2. SOLDERING TECHNIQUES

Working method:

- Carefully unsolder one after the other the soldering tags of the semi-conductor.
- Remove all superfluous soldering material. Use a sucking iron or sucking copper litze wire.
- Check that the tags of the replacement part are clean and pre-tinned on the soldering places.
- Locate the replacement semiconductor exactly on its place, and solder each tag to the relevant printed conductor on the circuit board.

**Note:** *Bear in mind that the maximum permissible soldering time is 10 seconds during which the temperature of the tags must not exceed 250 deg C. The use of a solder with a low melting point is therefore recommended.*

*Take care not damage the plastic encapsulation of the semi-conductor.*

**ATTENTION:** When you are soldering inside the instrument it is essential to use a low-voltage soldering iron, the tip of which must be earthed to the mass of the oscilloscope.

**Suitable soldering irons are:**

- ORYX micro-miniature soldering instrument. type 6A, voltage 6 V, in combination with PLATO pin-point tip type 0-569.
- ERSA miniature soldering iron, type minor 040B, voltage 6 V.
- Low Voltage Mini Soldering Iron. Type 800/12 W - 6 V, power 12 W, voltage 6 V, order no. 4822 395 10004, in combination with 1 mm-pin-point tip. order no. 4822 395 10012.

Ordinary 60140 solder and 35- to 40-watt pencil-type soldering iron can be used to accomplish the majority of the soldering. If a higher wattage-rating soldering iron is used on the etched circuit boards, excessive heat can cause the etched circuit wiring to separate from the board base material.

3.3. HANDLING MOS DEVICES

Though all our MOS integrated circuits incorporate protection against electrostatic discharges, they can nevertheless be damaged by accidental over-voltages. In storing and handling them, the following precautions are recommended.

*Caution*

Testing or handling and mounting call for special attention to personal safety. Personnel handling MOS devices should normally be connected to ground via a resistor.

Storage and transport

Store and transport the circuits in their original packing. Alternatively, use may be made of a conductive material or special IC carrier that either short-circuits all leads or insulates them from external contact.

Testing or handling

Work on a conductive surface (e.g. metal table top) when testing the circuits or transferring them from one carrier to another. Electrically connect the person doing the testing or handling to the conductive surface, for example by a metal bracelet and a conductive cord or chain. Connect all testing and handling equipment to the same surface.

Signals should not be applied to the inputs while the device power supply is off. All unused input leads should be connected to either the supply voltage or ground.

Mounting

Mount MOS integrated circuits on printed circuit boards after all other components have been mounted. Take care that the circuits themselves, metal parts of the board, mounting tools, and the person doing the mounting are kept at the same electric (ground) potential. If it is impossible to ground the printed-circuit board the person mounting the circuits should touch the board before bringing MOS circuits into contact with it.

Soldering

Soldering iron tips, including those of low-voltage irons, or soldering baths should also be kept at the same potential as the MOS circuits and the board.

Static charges

Dress personnel in clothing of non-electrostatic material (no wool, silk or synthetic fibres). After the MOS circuits have been mounted on the board proper handling precautions should still be observed.

Until the sub-assemblies are inserted into a complete system in which the proper voltages are supplied, the board is no more than an extension of the leads of the devices mounted on the board. To prevent static charges from being transmitted through the board wiring to the device it is recommended that conductive clips or conductive tape be put on the circuit board terminals.

Transient voltages

To prevent permanent damage due to transient voltages, do not insert or remove MOS devices, or printed circuit boards with MOS devices, from test sockets or systems with power on.

Voltage surges

Beware of voltage surges due to switching electrical equipment on or off, relays and d.c. lines.

9.4. SPECIAL TOOLS

Special tool for the slotted nut of the ACCU POSITION and XMAGN potentiometers, ordering number 5322 395 54024.

For those who want to make such a tool, we give a sketch with the dimensions in mm. The material is silversteel N094, tempered 40-45 RC.

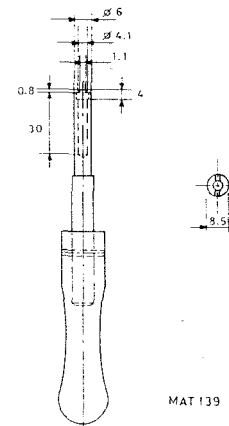

Fig. 9.4.1.

MAT 139

Extension card for plug-in units

To measure plug-in units of this oscilloscope an extension card is necessary.

Most components can be reached by the use of one extension card.

Complete access to all parts is possible by the use of two extension cards, but the wiring of some of the units is not long enough than.

Ordering number 5322 263 74144.

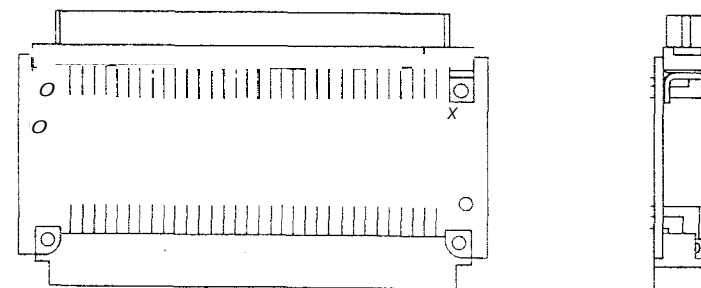

Fig. 9.4.2.

MAT 757

9.7. TROUBLE SHOOTING

9.7.1. Introduction

The following information is provided to facilitate trouble shooting. Information contained in other sections of this manual should be used along with the following information to aid in locating the defective component. An understanding of the circuit operation is helpful in locating faults, particularly where integrated circuits are used. See chapter 6 for this information.

9.7.2. Power-up routine

When switching on the instrument, note that the built-in microprocessor initiates an automatic test of a number of internal circuits including:

- Start test
- PROM test
- LED display test
- RAM test

The sequence and explanation of this power-up routine is as follows:

- a) Start test
    - Check that about 2 seconds after switching on, pilot lamps REMOTE, RUN, and NOT TRIG'D are ON
    - Check that all other pilot lamps and scale lamps are OFF.
- This is a visual check only. After this, the next test starts directly.

b) PROM test

This is a check-sum test of all the internal PROM circuits. PROMs 1 to 4 are checked in turn starting with PROM 1.

| PROM 1 | DISPLAY | SELECT |   |
|--------|---------|--------|---|
|        | ● ACCU  | ●      | - Check that the ACCU display and select switch ON. |
|        | ○ STO1  | ○      |   |
|        | ○ STO2  | ○      |   |
|        | ○ STO3  | ○      |   |

If a fault is found the test sequence stops and no other test is made.  
When no fault is found, the next test starts

PROM 2

| DISPLAY | SELECT |  |
|---------|--------|--|
| ● ACCU  | ●      | - Check that the STO1 display and select lamps also switch ON. |
| ● STO 1 | ●      |  |
| ○ STO 2 | ○      |  |
| ○ STO 3 | ○      |  |

If a fault is found the test sequence stops and no other test is made.  
Following a valid test result, the next test starts.

PROM 3

| DISPLAY | SELECT |  |
|---------|--------|--|
| ● ACCU  | ●      | - Check that the STO2 display and select lamps also switch ON. |
| ● STO 1 | ●      |  |
| ● STO 2 | ●      |  |
| ○ STO 3 | ○      |  |

If a fault is found the test sequence stops and no other test is made.  
Following a valid test result, the last PROM test starts.

9.5. RECALIBRATION AFTER REPAIR

After any electrical component has been replaced the calibration of that particular circuit should be checked, as well as the calibration of other closely related circuits. Since the power supply affects all circuits, calibration of the entire instrument should be checked if work has been done in the power supply or if the transformer has been replaced (see interaction table 8.4).

9.6. INSTRUMENT REPACKAGING

If the instrument is to be shipped to a Service Centre for service or repair, attach a tag showing owner (with address) and the name of an individual at your firm that can be contacted. The Service Centre needs the complete instrument serial number and a fault description.

Saw and re-use the packing in which your instrument was shipped. If the original packing is unfit for use or not available, repack the instrument in such a way that no damage during transport occurs.

|        |         |        |  |
|--------|---------|--------|--|
| PROM.4 | DISPLAY | SELECT |  |
|--------|---------|--------|--|

|   |      |   |
|---|------|---|
| ● | ACCU | ● |
| ● | STO1 | ● |
| ● | STO2 | ● |
| ● | STO3 | ● |

– Check that the STO3 display and select lamps also switch ON.

If a fault is found the test sequence stops and no other test is made.  
Following a valid test result, the RAM test will start.

c) LED-display test

Each segment of all the LED-display sections will be switched ON, so that the character  will be shown in every section.

All the pilot lamps and scale lamps on the front panel will be switched ON. In this way, the LED-displays and the indicator lamps can be visually checked.  
After about 3 seconds the next test is executed.

d) RAM test

This test checks only the micro-processor RAM and not the RAM memories ACCU, STO1, STO2 and STO3. The RAM part, of which the contents may be destroyed, is now checked by writing and reading a particular pattern.

If a fault is found, the system will stop. If no fault is detected, this RAM part will be cleared. The RAM part, in which the settings of the channel A and channel B AMPL/DIV switches, the TIME/DIV switch and the trigger delay and their check-sums are stored, may not be destroyed when using the battery back-up facility.

This RAM part will be check-sum tested (in the same way as the PROMS), and cleared when a fault is found (NOP will then be displayed in the alpha-numeric display).

**Summary:** If the tested circuits are working correctly, all tests will run through in an uninterrupted sequence and after the last test the instrument is ready for use.  
In the event of a fault, the test sequence will stop at the point of fault detection.  
The test sequence will still continue if a failure occurs in one of the pilot lamps or in the alpha-numeric displays.

### 9.7.3. Trouble shooting aids

#### **Print lay-out and circuit diagrams**

The instrument contains a number of functional units. For each of these units a complete detailed circuit diagram and a complete detailed print lay-out drawing is given.

Printed-circuit board lay-out drawings are printed on foldout pages on the left and circuit diagrams are printed on foldout pages on the right, next to each other.  
These drawings are located behind the detailed circuit description of the relevant unit.

Electrical values or types of the used components or the component item numbers are shown on the circuit diagram. For the used types of integrated circuits a table is provided.

Each component which is shown on the circuit diagram is marked on the print lay-out drawing by its item number.

Red symbols  on the circuit diagrams are indicating the testpoints which are available on the circuit boards.

Red symbols  on the circuit diagrams are indicating all the adjusting elements.

Red symbols  on the circuit diagrams are giving additional information.

For each integrated circuit and for all the connectors and transformers the pin configuration is given on the circuit diagram.

On the left side of the circuit diagram a part of the print connector is drawn which is giving the connector pin numbers of the incoming signals.

The part of the connector with the outgoing signals and their connector numbers is drawn on the right side of the circuit diagram.

#### **Circuit description**

Circuit descriptions (section 6) can be found in the manual in unit number sequence.

Each circuit description gives not only the explanation of the working principle of the unit but also a list of signal denominations and origins and destinations. Furthermore a number of timing diagrams are available.

#### **Locations of adjusting elements**

Drawings in section 8 "CHECKING AND ADJUSTING" show the locations of the different adjusting elements to locate these elements rapidly.

#### **I/O addresses**

The address codes for the input ports and the output ports are written in the circuit diagrams in hexa decimal notation. They can be found near to the I/O port circuitries.

## 9.7.4. Service faultfinding software routines

To facilitate fault finding the PM 3311 is provided with two internal service jumpers. These jumpers can select 3 service routines:

## 9.7.4.1. Interface test

## 9.7.4.2. Data and address bus test

## 9.7.4.3. Amplifier and time base setting test

The position of the jumpers, located at the component side of the switch board, is as follows:

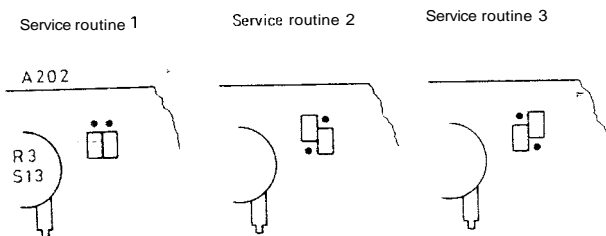

Rear view

- Note 1:** A service routine can be called only after switching off-and-on the instrument.  
**Note 2:** Both jumpers in upper position means normal operation  
**Note 3:** Always set the INTENS control fully counter clockwise

## 9.7.4.1. Interface test

This test is provided to check the Interface functions of microprocessor unit A4. To make this test useful, the user should know the principles of a microprocessor controlled system and the principles of the PM 3311. To start this test, the jumpers at the rear side of the switch board must be set as indicated in the figure at chapter 9-7-4, and afterwards switch-on the instrument again.

The following listing indicates the test sequence, which is executed approximately every 325  $\mu$ s.

- All alpha-numeric displays are filled with "1"
  - To trigger the measuring oscilloscope the SOD pulse at X418 of unit A4 gets active once per cycle
  - The pattern  $AA_H$  ( $1010\ 1010_2$ ) is written into the output ports:
 

|                 |   |             |
|-----------------|---|-------------|
| D2424           | } | (unit A211) |
| D2426           |   |             |
| D2427           | } | (unit A13)  |
| D1326           |   |             |
| D414            | } | (unit A4)   |
| D1308 and D1309 |   |             |
| D1311 and D1312 | } | (unit A131) |
| D1327           |   |             |

 and into the counters  
 and into the DAC
  - The pattern  $3F_H$  ( $0011\ 1111_2$ ) is written into the first address of the ACCU-RAM D601 and D602 (unit A6)
  - The TBS pulse is set to 25 kHz by setting  $A1_H$  ( $10100001_2$ ) into output port D1221
  - The pattern  $3F_H$  ( $0011\ 1111_2$ ) is read out of the ACCU D601 and D602 (unit 6) and written into output port D201.
- This results in lighting of the following scale-and-pilot lamps: UNCAL A and B; NOT TRIG'D RUN and the six scale lamps of the A and B AMPL/DIV switches and the TIME/DIV switch.
- The position of the pushbutton switches DISPLAY are copied to the corresponding SELECT pilot lamps.
  - The position of the push-pull-switches INVERT are copied to the corresponding DISPLAY pilot lamps.

**NOTE:** The ACCU DISPLAY pilot lamp can be reset by the AUTO or DC/AC triggering switches.  
 DC or AC: ACCU DISPLAY pilot lamp ON.  
 AUTO : ACCU DISPLAY pilot lamp OFF.

## 9.7.4.2. Address and data bus test

This test is provided to check the data and address bus. To start this test the jumpers at the rear side of the switch board must be set as indicated in the figure at chapter 9.7.4., and afterwards switch-on the instrument again.

The following listing indicates the test sequence, which is repeated every 3.8 ms.

- All alpha numeric displays shows "2"
- The patterns
 

|        |                    |
|--------|--------------------|
| $01_H$ | ( $0000\ 0001_2$ ) |
| $02_H$ | ( $0000\ 0010_2$ ) |
| $04_H$ | ( $0000\ 0100_2$ ) |
| $08_H$ | ( $0000\ 1000_2$ ) |
| $10_H$ | ( $0001\ 0000_2$ ) |
| $20_H$ | ( $0010\ 0000_2$ ) |
| $40_H$ | ( $0100\ 0000_2$ ) |
| $80_H$ | ( $10000\ 000_2$ ) |

 are written sequential into the data-ram D601 and D602.
- The above patterns are read out of the data-ram. If the data bus is incorrect the NOT TRIG'D pilot lamp will light. If the data bus is correct the next step is carried out.
- The data  $00_H$  upto and included  $FF_H$  are written in the data ram on the addresses  $C000_H$  upto and included  $C0FF_H$ .
- The above data are read out of the data ram.  
 If the address bus is incorrect the REMOTE pilot lamp will light. If the address bus is correct the test will start again.

### 9.7.4.3. Front panel switch setting test

This test is provided to copy the settings of the front panel switches (except for the trigger mode and trigger source switches) to the output ports continuously.

Now easy checking of switches, interconnections and output ports is possible.

To start this test, the jumpers at the rear side of the switch board must be set as indicated in the figure of chapter 9.7.4, and afterwards switch-on the instrument again.

The following listing indicates the test sequence:

- All alpha numeric displays are filled with "3"
- The front panel settings are compared and copied into the output ports:

02424  
02426  
D2427  
D1221

- The test repetition time is about 1 ms

### 9.7.5. Trouble-shooting hints

If a fault appears, the following test sequence can be used to find the defective circuit part:

- Check if the settings of the controls of the oscilloscope are correct. Consult the operating instructions in this manual.
- Check the equipment to which the oscilloscope is connected and the interconnection cables.
- Check if the oscilloscope is well-calibrated. If not refer to section 8 (checking and adjusting).
- Visually check the part of the oscilloscope in which the fault is suspected. In this way, it is possible to find faults such as bad soldering connections, bad interconnection plugs and wires, damaged components or transistors and IC's that are not correctly plugged into their sockets.
- Location of the circuit part in which the fault is suspected: the symptom often indicates this part of the circuit. If the power supply is defective the symptom will appear in several circuit parts.

After having carried out the previous steps, individual components in the suspected circuit parts must be examined:

- Transistors and diodes. Check the voltage between base and emitter (0.7 Volt approx. in conductive state) and the voltage between collector and emitter (0.2 Volt approx. in saturation) with a voltmeter or oscilloscope. When removed from the p.c.b. it is possible to test the transistor with an ohmmeter since the base/emitter and base/collector junctions can be regarded as diodes. Like a normal diode, the resistance is very high in one direction and low in the other direction. When measuring take care that the current from the ohmmeter does not damage the component under test. Replace the suspected component by a new one if you are sure that the circuit is not in such a condition that the new one will be damaged.
- Integrated circuits. In circuit testing can be done with an oscilloscope or voltmeter. A good knowledge of the circuit part under test is essential. Therefore first read the circuit description in section 6.
- Capacitors. Leakage can be traced with an ohmmeter adjusted to the highest resistance range. When testing take care of polarity and maximum allowed voltage. An open capacitor can be checked if the response for AC signals is observed. Also a capacitance meter can be used: compare the measured value with value and tolerance indicated in the parts list.
- Resistors. Can be checked with an ohmmeter after having unsoldered one side of the resistor from the p.c.b. Compare the measured value with value and tolerance indicated in the parts list.
- Coils and transformers. An ohmmeter can be used for tracing an open circuit. Shorted or partially shorted windings can be found by checking the wave-form response when HF signals are passed through the circuit. Also an inductance meter can be used.
- Data latches. To measure on inputs and outputs of data latches a measuring oscilloscope can be triggered by the clock signal which is connected to the clock input of the data latch. Check the input data lines one by one during the active edge of the clock signal. This measurement can only be done in this way when there is an acceptable repetition time of the clock signal. A too low clock pulse repetition time results in a low intensity of the trace on the C.R.T. screen of the measuring oscilloscope. The outputs can easily be checked for correct data by an oscilloscope or voltmeter

#### Oscilloscope checking of micro-processor bus signals

The 8085 micro-processor (D408) is provided with the following busses:

- Address bus
- Data bus
- Control bus

In general, if signals on these bus lines are checked with an oscilloscope, a very unstable display will be the result.

This is due to the fact that these signals vary with time in a rather unpredictable way.

If anyhow a stable display of signals from one of these busses is obtained, this may be an indication that the micro-processor runs in a small program loop.

**Note:** *Note:*

*if a component must be replaced always use a direct-replacement. If not available use an equivalent after carefully checking that it does not degrade the instrument's performance. See also section 9.1. (replacement).*

*After replacement of a component the calibration of the instrument may be affected due to component tolerances. If necessary do the required adjustments.*

Most of the test measurements can be carried out with a 2-channel oscilloscope and a voltmeter. Use of a 4-channel oscilloscope with delayed time-base (e.g. PM 3244 or PM 32641 is recommended. A number of measurements can also be done with a correct triggered logic analyzer. Probes must be earthed near to the measuring points.

- 9.7.6. Overall view of provisions and service methods especially for fault location in various digital circuitries of the instrument.

**FRONT BOARD A201**

The data to be displayed in the alphanumeric displays and the pilot lamps can be measured in the following way:

**Pilot lamps**

Trigger an oscilloscope with the clock signal on point 11 of the relevant latch D201 or D202 and check the data lines DO ... D7 one by one during the positive going edge of the clock signal. The data outputs can easily be checked for correct data by an oscilloscope or voltmeter.

**Alphanumeric displays**

Trigger the main time-base of an oscilloscope externally with the "DELAY LOOP TRIGGER" which is available on test point X412 of unit A4. Connect the signal IOA on point C21 of connector X424 on unit A4. with channel A of the oscilloscope and set the TIME/DIV switch to 0.2 ms/div. A group of 16 negative going IOA pulses is displayed now. Select this group of 16 pulses with the aid of the delayed time-base in such a way that a triggered display of 16 pulses divided over the whole ten divisions of the screen is obtained. The first IOA pulse belongs to address 80A0H and the last IOA pulse belongs to address 80AFH. By connecting the data lines DO ... D7 one by one to the B channel of the oscilloscope the data can be checked.

Set the oscilloscope for this check in ALT-mode and use the TBMAGN and XPOSITION controls.

**SWITCH BOARD A202**

For measuring on the switch board the instrument has to be set in the SERVICE ROUTINE NUMBER 3 (page 9-16) with the jumpers on unit A202.

**Switches**

The output signals of the front panel switches can be measured with a normal voltmeter on the CIS connectors or the input of the multiplexer's D241-D242-D243-D247-D248 and D249. Signals can be checked while operating the relevant switches.

**Multiplexers**

Trigger the MAIN TIME-BASE of a dual channel oscilloscope with one of the signals RDFO - RDF2 or RDF4 connected to the channel A input.

RDFO is available on testpoint X246 on unit A202

RDF2 is available on testpoint X244 on unit A202

RDF4 is available on testpoint X243 on unit A202

Set the measuring oscilloscope in 5  $\mu$ s/div. - DC - TRIG - SLOPE "..." and correct LEVEL.

Connect the data lines DO ... D7 one by one to the channel B input and check the data during the positive going edges of the trigger signal on channel A when operating the relevant front panel switches.

**MICROPROCESSOR UNIT A4**

Every  $\approx$  20 ms a number of trigger pulses are generated by the software for test purposes.

- Trigger pulse "START MAINLOOP" is available at X407.
- Trigger pulse "START DISPLAY LOOP" is available at X409.
- Trigger pulse "START DELAY LOOP" is available at X412.

Latches and bidirectional buffer D413 - D414 - D416 and D417 are placed in sockets and can be easily removed from the unit for test purposes.

- Removing D413 results in disconnecting the internal address bus from the internal address/data bus.
- Removing D414 results in disconnecting the output port from the system.



- Removing D416 results in disconnecting the system address bus from the internal address/data bus.
- Removing D417 results in disconnecting the system data bus from the internal address/data bus.

This can for example be used to separate and locate the fault in case of a short-circuit in one of the busses

The unit contains a number of soldering spots with the following functions:

- Signal RST 7.5 can be connected to the +5 V for test purposes. This is not of interest for servicing in standard instruments.
- PROM address line A11\* can be disconnected from the +5 V and connected to address line A11 from the microprocessor. This is necessary in case the IEC option PM 3325 is used because of the use of a PROM circuit D407 of 4096 x 8 bits.
- For test purposes the RESIN input circuit (watchdog circuit) can be replaced by a simple reset circuit with C411.
- The TRAP input circuitry can be made inactive for service purposes.

To measure the signals ZEN - INV and CLDT, the measuring oscilloscope must be triggered with the signal on X407 (START MAIN LOOP).

- ZEN can be checked by operating the front panel display select switches.
- INV can be checked by operating the front panel invert switches for STO1-2 and 3.

The input data lines for the latch D414 can be measured with the method described in section 9.7.5

#### Fault finding method

- Check supply voltages.
- Check whether the "START MAIN LOOP" trigger is present once every 20 msec at testpoint X407 on unit A4 or not.
- Check if the  $\mu P$  is switched in the HOLD-state. RD and WR are then switched to about 1.5 V (can be done via input TRAP for example).



- Disconnect TRAP input (solder spot).
- Disconnect the WATCHDOG circuit and connect C411 to RESIN (solder spot).
- Replace eventually the  $\mu P$  itself.
- Replace eventually the PROM circuits.
- Check the busses for short circuits or interrupts. For this, latches and bidirectional buffers can be removed from their sockets.

After the repair everything must be brought in the normal position again

#### RAM UNIT A6

Tri-state buffer D617 can be removed from its socket so that no data can be placed on the system data bus by the RAM unit.

#### BUFFER UNIT A7

A solder spot is available in the CLKSH circuitry for test purposes. So a CLKSH can be derived from signal C4 which is generated during the time that the ADC output is placed on the ADC bus. The ADC output contents can then directly be placed in the shift register without correction.

Using this facility in combination with the interruption of signal line DAC M-1, results in the switching off of the total correction circuitry.

After the repair everything must be brought in the normal position again

#### TIME-BASE UNIT A12

For test purposes in ROLL-mode, the ROLL-mode action can be done 5000 times faster by placing jumper S1201 in the left position.

#### Check for correct time-base setting

Select service test routine number 3.

The TIME/DIV switch position is now read by the microprocessor and this processor in turn will set the belonging code (according to the table on page 6-136) on the data lines DO ... D7 so that it can be latched by latch D1221 on unit A12.

These codes can be measured on the inputs of latch D1221 by triggering a monitor oscilloscope with the clock signal on D1221-pt. 11. Now the data lines can be observed one by one during the active edge of the clock signal. Codes on the outputs of the latch can be measured with a voltmeter or an oscilloscope.

In this way the correct functioning of the TIME/DIV switch, the microprocessor and the latch D1221 can be checked for RECURR-mode as well as for ROLL-mode. (In ROLL-mode D5 will steady be "0") and different TIME/DIV switch positions.

Now all the dividers and multiplexers can be checked for all the TIME/DIV switch positions in a simple way.

#### ROLL-mode check 0.5 s/div ... 60 min/div

- Depress pushbutton ROLL.
- Set jumper S1201 in the left position.
- Measure the TBS signal on D1219 - point 7 with an oscilloscope and check the signal repetition time in accordance with the table below.

| TIME/DIV switch setting | Signal repetition time |
|-------------------------|------------------------|
| 60 min/div              | 28.80 ms               |
| 30 min/div              | 14.40 ms               |
| 15 min/div              | 7.20 ms                |
| 6 min/div               | 2.88 ms                |
| 2 min/div               | 0.96 ms                |
| 1 min/div               | 0.48 ms                |
| 0.5 min/div             | 0.24 ms                |
| 20 s/div                | 160 $\mu s$            |
| 10 s/div                | 80 $\mu s$             |
| 5 s/div                 | 40 $\mu s$             |
| 2 s/div                 | 16 $\mu s$             |
| 1 s/div                 | 3 $\mu s$              |
| 0.5 s/div               | 4 $\mu s$              |

- Set the jumper S1201 again in the right position

#### RECURR-mode check 0.2 s/div ... 0.5 ms/div

- Depress pushbutton RECURR.
- Measure the TBS signal on D1219 - point 7 with an oscilloscope and check the signal repetition time in accordance with the table below.

| TIME/DIV switch setting | Signal repetition time |
|-------------------------|------------------------|
| 0.2 s/div               | 3 ms                   |
| 0.1 s/div               | 4 ms                   |
| 50 ms/div               | 2 ms                   |
| 20 ms/div               | 800 $\mu s$            |
| 10 ms/div               | 400 $\mu s$            |
| 5 ms/div                | 200 $\mu s$            |
| 2 ms/div                | 80 $\mu s$             |
| 1 ms/div                | 40 $\mu s$             |
| 0.5 ms/div              | 20 $\mu s$             |

RECURR-mode check 0.2 ms/div ... 0.2 μs/div

- Depress pushbutton RECURR.
- Measure the TBF signal on X1206 in accordance with the table below

| TIME/DIV switch position | Signal repetition time |
|--------------------------|------------------------|
| 0.2 ms/div               | 8 μs                   |
| 0.1 ms/div               | 4 μs                   |
| 50 ps/div                | 2 μs                   |
| 20 μs/div                | 0.8 μs                 |
| 10 μs/div                | 0.4 μs                 |
| 5 μs/div                 | 0.2 μs                 |
| 2 μs/div                 | 0.08 μs                |
| 1 μs/div                 | 0.04 μs                |
| 0.5 μs/div               | 0.02 μs                |
| 0.2 μs/div               | 80 ns                  |

#### DELAY TRIGGER UNIT A13

There are **two** solder spots available on the unit. One to invert the PENLIFT output signal and a solder spot to connect the input trigger TRIST directly with the output signal line DELTRG. In this way the whole delayed trigger circuit is switched off, and the trigger point is at the right-hand side of the CRT screen.

Check for **correct** latch, delay counter and **DAC** delay setting

The input data lines for the latch D1326, the counters D1308 - D1309 - D1311 and D1312 and the DAC DELAY D1327 can be measured with the method described in section 9.7.5.

Trigger signals

|                |  |
|----------------|--|
| D1324 - pt. 8  | for data latch D1326                       |
| D1324 - pt. 6  | for MSB of delay counter                   |
| D1324 - pt. 12 | for LSB of delay counter and for DAC DELAY |

The delay counter (used in D- and P-mode) is set according to the formula:

$$\text{Counter setting} = \{(10+N) \cdot 5+8\}$$

In this formula N is the number of divisions set by the user ( $-9 \leq N \leq 9999$ ).

Note that the four least significant bits the inverted information is placed on the data bus.

The DAC DELAY (used in S-mode) is set in the following way:

$$\text{DAC DELAY setting} = 2 \cdot N$$

N is the number of divisions set by the user ( $0 \leq N \leq 1001$ )

#### DC POWER SUPPLY A15

Dummy load for PM 3310 power supply

| Voltage | Load resistance |                 |
|---------|-----------------|-----------------|
| - 12 V  | 15.6 Ω          | (3 x 47 Ω //)   |
| + 12 V  | 15.6 Ω          | (3 x 47 Ω //)   |
| - 6 V   | 40 Ω            | (47 Ω // 220 Ω) |
| + 6 V   | 40 Ω            | (47 Ω // 220 Ω) |
| - 5.2 V | 5 Ω             | (2 x 10 Ω //)   |
| + 5 v   | 25 Ω            | (4 x 10 Ω //)   |
| + 40 V  | 300 Ω           |                 |
| -125 V  | 10kΩ            |                 |
| +125 V  | 10kΩ            |                 |

#### INPUT AMPLIFIER UNIT A21

Check for **correct** latch setting

The input data lines for the latches D2424 - D2426 and D2427 can be measured with the method described in section 9.7.5.

Multiplexer check

Trigger the MAIN-TIME-BASE of a dual channel oscilloscope with the external trigger signal "MAIN LOOP TRIGGER" which is available on testpoint X407 on unit A4.

Connect the signal on point 6 of D2423 on unit 21 with the channel A of the oscilloscope and set the TIME/DIV switch to 20 μs/div.

Two negative going pulses are displayed now.

Select these two pulses with the aid of the delayed time-base in such a way that a triggered display of these **two** pulses is obtained.

During the first pulse multiplexers D2418 and D2419 are set to the "T" position and during the second pulse they are set to the "1" position.

By connecting the data lines DO ... D7 one by one to the B channel of the oscilloscope the data can be checked.

**Checking the protective leads**

The correct connection and condition is checked by visual control and by measuring the resistance between the protective-lead connection at the plug and the cabinet.

The resistance should be  $< 0.5 \Omega$ . During measurement the mains cable should be moved. Resistance variations indicate a defect.

**Checking the insulating resistance.**

Measure the insulating resistance at  $U_{dc} = 500 \text{ V}$  between the mains connections and the protective lead connections.

For this purpose set the mains switch to ON. The insulating resistance should be  $> 2 \text{ M}\Omega$ .

#### 9.7.7. Mains voltage setting

If the instrument is to be used at a mains voltage between 110V and  $120\text{V} \pm 10\%$  (115V visible in the mains adaptor switch window) or between 220V and  $240\text{V} \pm 10\%$  (230V visible in the window), the appropriate voltage should be selected by switching the mains adaptor switch at the rear of the instrument.

If the **mains** plug has to be adapted, the mains cord must be connected as stated below:

|                       |                    |
|-----------------------|--------------------|
| green or green/yellow | : protective earth |
| black or brown        | : phase            |
| white or blue         | : neutral          |

## 10. INTRODUCTION TO MICROPROCESSORS

### 10.1. A BRIEF ENCOUNTER

Microcomputers, like people, do not reveal all their secrets at a brief encounter. If this is your first Introduction to a microcomputer, you will need a little time to familiarise yourself with its characteristics — what it can do, how it does it and how its facilities are best used to advantage.

As its name implies, a microcomputer is an extremely small device. Extremely small because it is based on a silicon-chip microprocessor.

The great future predicted for the microprocessor lies in its *enormous* work capacity for processing signals, available within negligible physical capacity.

The human brain has the ability to determine by calculation in a more sophisticated way, but our micro-computer, with its built-in 'one-track' mind, is capable of much faster calculation speeds. Also the computer facilities extend beyond the confines of the brain and memory to perform some of the functions we allocate to other parts — the eyes, ears, arms and legs.

Besides the ability to store and manipulate information, the microprocessor circuits are capable of recognising visual, aural and physical conditions, evaluating them and presenting them in a form required by an instrument or operator. A practical application of this could be the monitoring of strain-gauges or thermometers in an industrial process at regular intervals and the recording of the values, together with any alarm conditions, on a print-out. In contrast to this data logging function, the microcomputer could be an integral part of a laboratory measuring instrument, e.g. a digital oscilloscope, for control, storage and read-out purposes.

Microcomputers are designed with built-in flexibility to enable them to be used for a wide variety of applications. This versatility is obtained in the signal conditioning circuits that present the data to the computer central processing unit in a form that it can readily understand. In electronics, the simplest and most reliably defined condition is when a circuit is either switched on or switched off. This two-state notation of defining the numerical terms of a problem is universally used in computers and is known as the binary system.

### 10.2. COMING TO TERMS

After a general picture of the microcomputer field, it is useful to look a little closer at the practical aspects and to discuss some of the terms that are in everyday use.

|               |   |
|---------------|---|
| Microcomputer | A miniature electronic system that performs arithmetic and logic operations on data according to a programmed sequence of instructions stored in a memory.<br>As a calculating system, the microcomputer consists not only of the physical components (the hardware) but also of program instructions (the software). |
| Hardware      | The mechanical, electronic and electromechanical components of the computer system.   |
| Software      | The programmer's language for communicating with the computer. This includes sets of programs translated into binary form to enable the computer to perform specific functions as required by the system user.  |

**Microprocessor CPU** The heart of the microcomputer, the central processing unit (CPU) that performs all the functions as arithmetic and logic operations that are written in the system software program. In addition to the Arithmetic and Logic Unit (ALU) it also contains a Control Block and Register Array.

**Memory** A high-speed electronic device in which data and instructions are stored for subsequent processing.

**Input/Output** Devices that provide communication between the microcomputer System and the outside world. For example, interfacing input data and instructions via a keyboard and outputting results via a display unit or printer.

**Instruction set** A set of characters that define an operation with generally one or more addresses, which are given via the input device and can be stored in the memory. When a program is running, data-words are processed in a sequence and manner as specified by the instructions, the results being stored and/or outputted via an output device.

**Data word** A word, or group of binary digits (bits) used to encode data, as distinct from an instruction word. A byte is a word of 8 bits.

**Binary notation** A system of numbering used in computers that uses 2 as a base in contrast with the normally used decimal system that has 10 as a base. Only two symbols are required in the binary system, 0 and 1, which can be conveniently represented in electronic circuits as two voltage levels in a signal. The binary equivalents of the decimal numbers 0 to 10 are as follows:

| DECIMAL | BINARY |
|---------|--------|
| 0       | = 0000 |
| 1       | = 0001 |
| 2       | = 0010 |
| 3       | = 0011 |
| 4       | = 0100 |
| 5       | = 0101 |
| 6       | = 0110 |
| 7       | = 0111 |
| 8       | = 1000 |
| 9       | = 1001 |
| 10      | = 1010 |

Addition:

| DECIMAL | BINARY |
|---------|--------|
| 5       | 0101   |
| +9      | +1001  |
| <hr/>   | <hr/>  |
| 14      | 1110   |

To add binary numbers, proceed as in decimal but remember that the radix is 2, i.e. carry 1 when 2 is reached.

**Hexadecimal notation**

Using 16 as a base this system provides a short-hand method of writing 4-bit binary numbers with alphanumeric symbols. This is useful for a data-word grouped as a 4-bit field, where there are 16 combinations.

| COMBINATION | BINARY CODE | HEXADECIMAL CODE |
|-------------|-------------|------------------|
| 0           | 0000        | 0                |
| 1           | 0001        | 1                |
| 2           | 0010        | 2                |
| 3           | 0011        | 3                |
| 4           | 0100        | 4                |
| 5           | 0101        | 5                |
| 6           | 0110        | 6                |
| 7           | 0111        | 7                |
| 8           | 1000        | 8                |
| 9           | 1001        | 9                |
| 10          | 1010        | A                |
| 11          | 1011        | B                |
| 12          | 1100        | C                |
| 13          | 1101        | D                |
| 14          | 1110        | E                |
| 15          | 1111        | F                |

**Analog-to-Digital Converter**

Enables physical or electrical input signals that are in analog form to be converted to digital form for processing in the computer.

**Register**

Consists of a group of two-state flip-flops, which by means of a clock-pulse command can store the data-word present on its input lines. The output lines remain stable until a new data-word is clocked into the register. A group of registers forms a memory.

**Data-bus**

Enables several circuits to communicate with each other without the need for separate data paths. This databus is common to all circuits and a timing and control circuit organises which circuits use the databus at any particular time, in conjunction with an ADDRESS-BUS and a CONTROL-BUS.

**Address-bus**

Enables memory locations to be addressed by their unique device numbers

**Control-bus**

Controls the exact timing of the communication on the data-bus and also the direction of data flow.

Output features

The output interface circuits are designed to present the output data in a form suitable for the various system requirements, e.g. digital displays, print-outs, parallel and serial interfaces, alarms, etc. When analog output signals are required, digital-to-analog conversion (DAC) is performed in the computer output interface circuits.

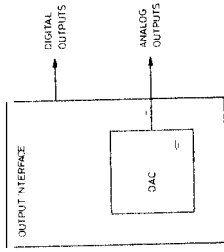

MAT 760

Fig. 10.3.3.

Memory features

A memory is simply a group of registers used for storing data-words, for future retrieval when required. With a WRITE pulse, a data-word can be stored; a READ pulse enables a data-word to be read out of a location. An ADDRESS must be provided with the READ and WRITE pulses to locate the specified data-word. Memories can be used for storing signal data or for programming instructions. Instruction sets for microcomputers are usually stored in read-only memories, ROMs or PROMs (Program Read Only Memories).

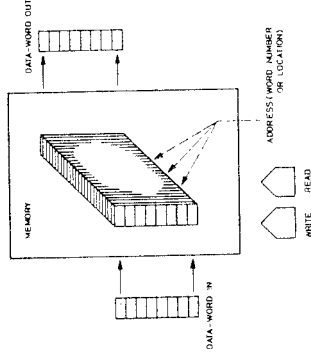

MAT 761

Fig. 10.3.4.

The memory contains not only the information to tell the microprocessor what to do, but also the instructions on how to do it. Variable data are usually stored in random-access memories, RAMs.

10.3. SYSTEM FEATURES

With a basic understanding of the language and hardware component parts of a microcomputer it is interesting to discover how these can be integrated to form an organised system. The following illustrations show the basic system features which, for greater comprehension, should be studied with reference to the computer terms that have been previously defined.

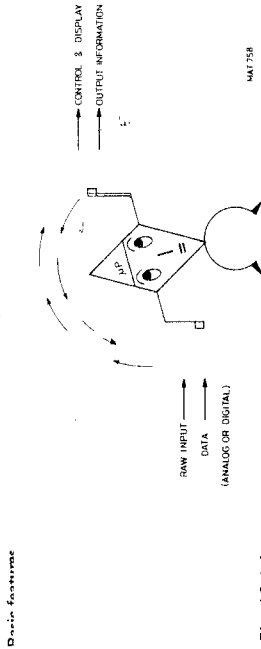

MAT 758

Fig. 10.3.1

In simple terms, our Master Microcomputer takes data with one hand, juggles with it, and hands it out with the other. Being highly intelligent, its right hand definitely knows what its left hand is doing!

Input features

The raw inputs from analog sources such as thermocouples, strain-gauges voltage and current devices, etc., must first be converted to the digital form required by an ADC in the signal conditioning part of the microcomputer. Digital inputs from switch contacts, logic levels from solid-state devices or from counters, etc., must be converted to the correct logic levels within the signal conditioning part.

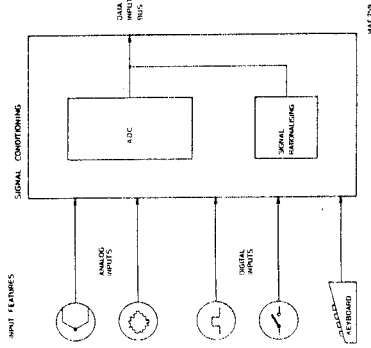

MAT 759

Fig. 10.3.2.

Microprocessor features

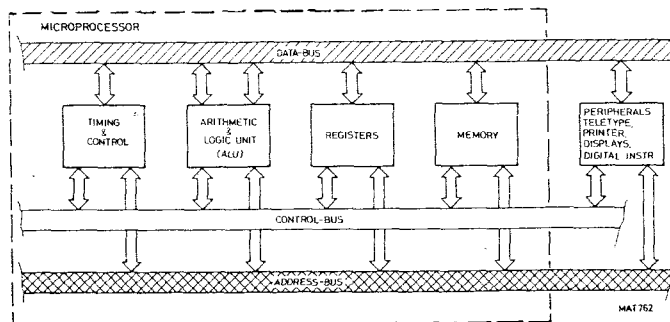

Fig. 10.3.5.

The elementary circuits of a microcomputer comprise

- registers
- a memory (ROM+ RAM)
- a data-bus, control-bus and address bus
- a data bus, timer and controller circuit
- an arithmetic and logic unit (ALU)

If the integrated circuit contains no memory, or only a limited memory, we refer to this as a microprocessor. The microcomputer, together with its memory and the peripheral equipment constitute the hardware of the system.

Programming features

In order to perform meaningful operations with the hardware of a computer system we need to specify precisely

- what OPERATIONS are required upon a defined DATA WORD
- in what SEQUENCE these will occur
- to which LOCATION the results of the operation have to be deposited

This process of prescribing the necessary actions within a computer system is called PROGRAMMING the computer software.

Programming consists of the sequential execution of the instructions stored in the memory, under the control of the TIMING and CONTROL part. Its circuits decode the instruction and initiate the necessary data word transports and operations.

A basic flow-chart cycle for each instruction is as follows

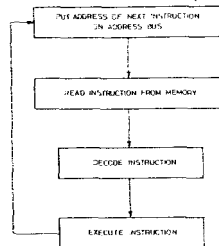

Fig. 10.3.6.

A PROGRAM COUNTER is a special register equipped to increment the address of sequential instructions to enable new instructions to be FETCHED from the memory. As the program counter is connected to the data-bus, the contents can be replaced by other values to permit a JUMP to an instruction elsewhere in the memory.

As the execution of an instruction consists of a number of sub-steps, it is useful to be able to store an instruction temporarily in a register if the next operation needs to use this result. The two operations are combined in a single register, called the ACCUMULATOR for ease of presentation to the ALU in the next instruction.

Apart from the memory, microcomputers usually have some general-purpose registers to store intermediate results on a temporary basis.

Note: For more information refer to: "INTRODUCTION TO MICROPROCESSORS AND THEIR USE IN T&M INSTRUMENTS". Ordering number: 9499 9900711.

# EXPLANATION OF USED SYMBOLS

## INTRODUCTION

Common control block

The use of binary logic integrated circuits (M.S.I.) necessitated an abbreviated notation for the interdependency of various functions, as well as simplified symbols for complex functions.

The most important information is: which signals appear at the input and how the outputs behave with respect to the function of the IC.

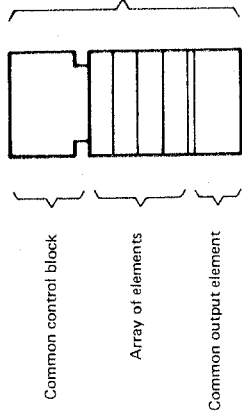

Common control block

On the common control block, all common input lines are connected. These lines must have functional relation to the other elements of the symbol. Examples: general reset, output enable, inhibit input, clock signal etc.

- OUTPUT ENABLE
- INHIBIT INPUT
- CLOCK
- RESET

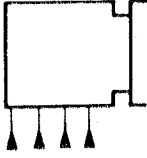

Array of elements

Each element of the array has its own in-and outputs. Example: it can be a D-flip-flop with one data input and two outputs (one inverted and the other not inverted).

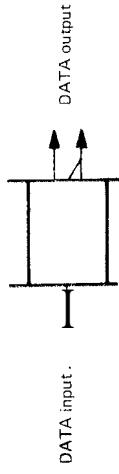

Forcing reset input

Forcing set input

Carry input of an arithmetical element

Carry output of an arithmetical element

Line carrying no logic information (input)

Line carrying no logic information (output)

Clock input

Signal timing relationship

Count command for counter

Countdown command for counters

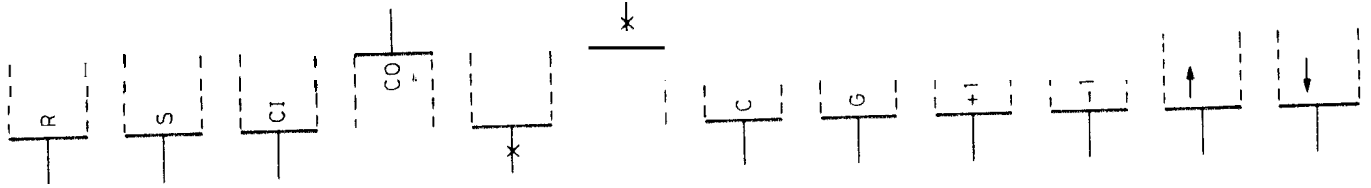

Shift right (down) command for shift register



LIST OF CHARACTERS AND SYMBOLS

In the common control blocks, characters and symbols are used to indicate the function of the individual outputs.

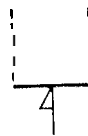
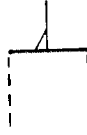
SYMBOL DESCRIPTION

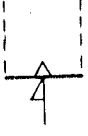
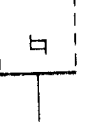
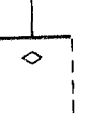
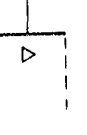
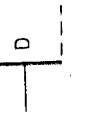
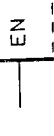
|   |                                      |
|---|--------------------------------------|
|    | Timing indicator to which            |
|    | Polarity indicator at output         |
|    | Dominant input                       |
|    | Dominant output with delay indicator |
|    | Schmitt trigger input                |
|   | Output to reset                      |
|  | Tri-state output                     |
|  | D-input                              |
|  | Enable output                        |



BASIC SYMBOLS

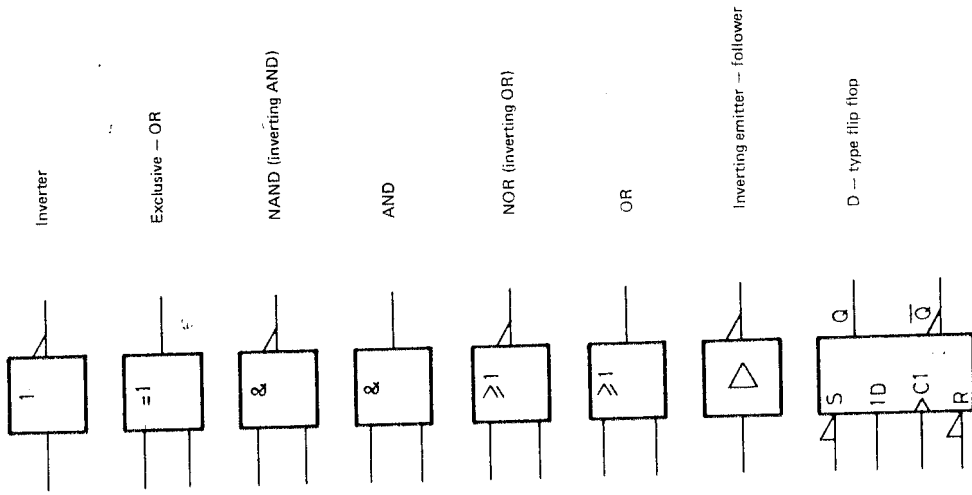

Common output element  
On the common output element the common or resulting outputs of the elements are drawn.  
Example: it can be a carry or a borrow signal for a counter.



Input and output lines  
Input lines are drawn at the left side of a symbol, output lines at the right side. In-and output lines can be drawn with and without triangles as shown.

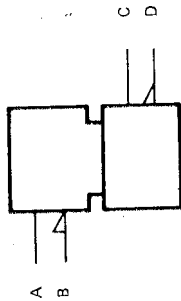

- Meaning of the above-drawn lines A, B, C and D:
- Line A is active for the block when it is high ("1") and inactive when it is low ("0").
  - Line B is active for the block when it is low ("0") and inactive when it is high ("1").
  - Line C is low ("0") in the rest state of the element or when output is inhibited. This output is then inactive.
  - Line D is high ("1") in the rest state of the element or when output is inhibited. This output is then inactive.
  - When line C is "high", this output is active.
  - When line D is "low", this output is active.

DEPENDENCY NOTATION

1 Introduction

Dependency notation is a means of denoting the relationship between inputs outputs and between inputs and outputs, without actually showing all the element and interconnections involved

Apart from its use in complex element, dependency notation should not be used to replace the symbols for combinative elements.

The information provided by dependency notation supplements that provided by the qualifying symbol for an element's function

In the convention for the dependency notation, use is made of the terms "affecting" and "affected" In the case where it is not evident which inputs must be considered as being the affecting or the affected ones (e.g. if they stand in an AND relation), the choice may be made in any convenient way

Ten different kinds of dependency have been derived They are

- 4 ADDRESS - dependency
- C CONTROL - dependency
- EN ENABLE - dependency
- G AND - dependency
- M MODE - dependency
- N NEGATE - dependency
- R RESET - dependency
- S SET - dependency
- V OR - dependency
- Z INTERCONNECTION - dependency

Each dependency is represented by a capital letter or letter combination as shown above

AND- OR- and NEGATE-dependencies are used to denote Boolean relationships between inputs and/or outputs INTERCONNECTION dependency is used to indicate that an input or output is connected to one or more inputs and/or outputs

CONTROL-dependency is used to identify a timing input or a clock input of a sequential element and to indicate which inputs are controlled by it

SET- and RESET-dependencies are used to specify the internal logic states of an RS bistable element in the case that the R- and S-inputs both stand at their internal 1-states

ENABLE-dependency is used to identify an ENABLE-input and to indicate which inputs and/or outputs are controlled by it (e.g. which outputs take on their high impedance state)

MODE-dependency is used to identify an input which selects the mode of operation of an element and to indicate the inputs and or outputs depending on that mode

ADDRESS-dependency is used to identify the ADDRESS inputs of a memory

The table below lists the various dependencies and summarizes their effects In this table the word "action" implies

- that affected inputs will have their normally defined effect on the function of the element
- that affected outputs will take on the internal logic states as determined by the function of the element.

2. Convention

- a. Dependency notation usually defines relationships between internal logic states. However in the case of 3-state outputs and open circuit outputs, ENABLE-dependency defines relationship between the internal logic states of affecting inputs and the external states of affected outputs.
- b. Application of dependency notation is accomplished by:
  - labelling the affecting input or output with the relevant letter followed by an identifying number;
  - labelling each input or output affected by that affecting input or output with that same number;
  - labelling each input or output affected by the negated internal logic state of the affecting input or output with that same number with a bar over it.
- c. If the affected input or output already has a label, denoting its function, this label must be prefixed by the identifying number of the affecting input.
- d. If an input is affected by more than one affecting input or output, the identifying number of each of the affecting inputs or outputs shall appear in the label of the affected one, separated by commas. The normal reading order of these identifying numbers is the same as the sequence of the affecting relationship.
- e. Two affecting inputs labelled with different letters, must not have the same identifying number, unless when one of the letters is A.
- f. If two affecting inputs or outputs have the same letter and the same identifying number, they stand in an OR-relation to each other.
- g. If an affected input or output already has a label which would form an ambiguous combination with the identifying number, the latter must then be replaced by a different character (e.g. Greek letter) to avoid ambiguity.
- h. An affecting input or output affects only the corresponding affected input or outputs of the element.

| Type of dependency | Letter(s) | Effect on affected input or output if the affecting input stands at its internal 1-state 0-state |  |
|--------------------|-----------|--|--|
| ADDRESS            | A         | permits action (address selected)  | prevents action (address not selected)   |
| CONTROL            | C         | permits action   | prevents action  |
| ENABLE             | EN        | permits action   | prevents action of affected inputs<br>- imposes external high-impedance state on open-circuit and 3-state outputs (internal state of 3-state outputs unaffected)<br>- imposes 0-state on other outputs |
| AND                | G         | permits action   | imposes 0-state  |
| MODE               | W         | permits action (mode selected)   | prevents action (mode not selected)  |
| NEGATE             | U         | complements state  | no effect  |
| RESET              | R         | affected output reacts as it would to S=0, R=1   | no effect  |
| SET                | S         | affected output reacts as it would to S=1, R=0   | no effect  |
| OR                 | V         | imposes 1-state  | permits action   |
| INTERCONNECTION    | Z         | imposes 1-state  | imposes 0-state  |

## 12. PARTS LISTS

**(subject to alteration without notice)**

The opening of parts, or removal of covers, is likely to expose live conductors. The instruments should therefore be disconnected from all voltage sources before any opening of parts or removal of covers is started. During and after dismantling, bear in mind that capacitors in the instrument may still be charged even if the instrument has been separated from all voltage sources.

Item numbers (e.g. C R V) have been divided in groups which relate to the circuit, the unit and the circuit diagram, according to the following table.

| Item numbers  | Location                | Unit number |
|---------------|-------------------------|-------------|
| 100 ... 199   | Front side unit         | A7          |
| 200 ... 299   | Front unit              | A2          |
| 300 ... 399   | Mother board unit       | A3          |
| 400 ... 499   | Microprocessor unit     | A4          |
| 500 ... 599   | Spare unit              | A5          |
| 600 ... 699   | Ram unit                | A6          |
| 700 ... 799   | Buffer unit             | A7          |
| 800 ... 899   | Conversion unit         | A8          |
| 900 ... 999   | ACL unit                | A9          |
| 3200 ... 3399 | CCD logic unit          | A10         |
| 1100 ... 1199 | P <sup>2</sup> CCD unit | A11         |
| 1200 ... 1299 | Time-base unit          | A12         |
| 1300 ... 1399 | Delay trigger unit      | A13         |
| 1400 ... 1499 | IEC unit (OPTIONAL)     | A14         |
| 1500 ... 1599 | DC POWER UNIT           | A15         |
| 1600 ... 1699 | AC POWER UNIT           | A16         |
| 1700 ... 1799 | Rear side unit          | A17         |
| 1800 ... 1899 | Delay line              | A18         |
| 1900 ... 1999 | CRT socket              | A19         |
| 2000 ... 2399 | Final ampl. unit        | A20         |
| 2400 ... 2699 | Ampl. unit              | A21         |
| 3000 ... 3099 | Ampl. unit              | A21         |
| 2700 ... 2999 | Trigger unit            | A22         |
| 3100 ... 3199 | EHT unit                | A23         |
| 3400 ... 3499 | Driver unit             | A34         |

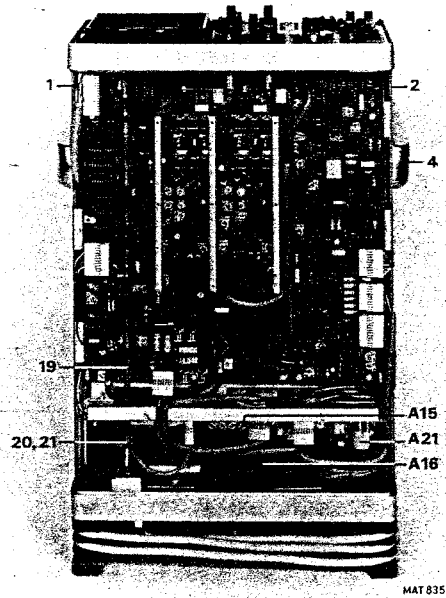

Fig. 12.1.1.

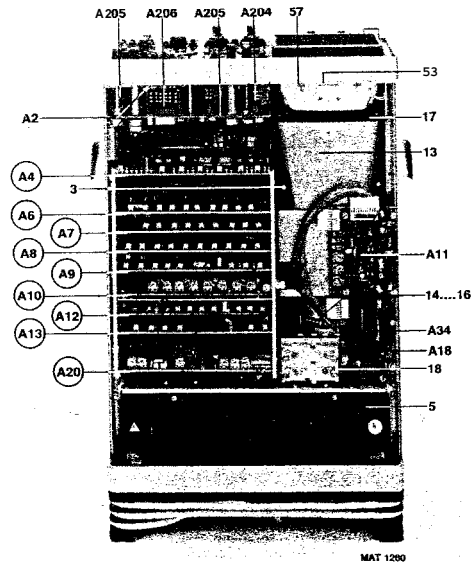

Fig. 12.1.2.

12.1. MECHANICAL PARTS

| Item | Qty | Order number   | Description            |
|------|-----|----------------|------------------------|
| 1    | 1   | 532246064042   | Side profile left      |
| 2    | 1   | 532244794625   | Side profile right     |
| 3    | 2   | 5322 462 34199 | Print support          |
| 4    | 2   | 532252834113   | Arret for handle       |
| 5    | 2   | 5322447 94638  | Cover top and bottom   |
| 6    | 1   | 532281522804   | Cil bolt M4X6          |
| 7    | 1   | 482250510488   | Square nut M4          |
| 8    | 1   | 532253214593   | Washer 4. 3X12         |
| 9    | 1   | 482253080077   | Spring washer 5.2      |
| 10   | 1   | 532281528054   | Cil bolt M3X8          |
| 11   | 1   | 482253210332   | Washer 3. 2X7          |
| 12   | 1   | 482253080173   | Spring washer          |
| 13   | 1   | 532246254154   | CRT shielding          |
| 14   | 1   | 5322 492 64767 | Clamping strip         |
| 15   | 1   | 4822 502 10051 | Cil bolt M4X20         |
| 16   | 1   | 482250510488   | Square nut M4          |
| 17   | 1   | 532246664213   | Plastic profile 30cm   |
| 18   | 1   | 532225664014   | Battery holder         |
| 19   | 1   | 5322 535 94978 | Shaft assy             |
| 20   | 1   | 5322 532 24398 | Coupling               |
| 21   | 2   | 482750210668   | Screw for coupling     |
| 27   | 1   | 532245584091   | Textplate              |
| 23   | 3   | 532241434134   | Knob dia 10            |
| 24   | 3   | 537249264337   | Clamping spring knob   |
| 25   | 9   | 532241434091   | Knob dia 10 shaft 6    |
| 26   | 2   | 532241434249   | Attenuator knob assy   |
| 27   | 1   | 5322 414 34261 | Time/div knoo assy     |
| 28   | 3   | 5322 532 54478 | Distance washer        |
| 29   | 2   | 5322 462 44458 | Housing                |
| 30   | 2   | 532246244459   | Cover                  |
| 31   | 2   | 5322 492 54338 | Compression spring     |
| 32   | 2   | 532226814157   | Contact pin            |
| 33   | 1   | 5322 466 85887 | Cover for iEC conn.    |
|      | 1   | 532248034046   | Contrast filter GREY   |
|      | 1   | 532248034074   | Contrast filter BLUE   |
| 37   | 1   | 5322 466 74059 | Bezel                  |
| 38   | 1   | 5322 480 34046 | Contrast filter        |
| 39   | 1   | 5322 447 94169 | Front cover            |
| 40   | 1   | 5322 447 94626 | Top cover              |
| 41   | 1   | 532246664214   | Adhesive strip         |
| 42   | 1   | 532244794627   | Bottom cover           |
| 43   | 1   | 532245584092   | Text strip             |
| 44   | 1   | 532249854042   | Aluminium profile      |
| 45   | 1   | 5322 498 54045 | Plastic profile        |
| 46   | 2   | 5322 535 74401 | Locking pin            |
| 47   | 2   | 5322 492 54155 | Compression spring     |
| 48   | 1   | 532249854044   | Bracket left           |
| 49   | 1   | 532249854043   | Bracket right          |
| 50   | 5   | 532241474029   | Knob cover blue +line  |
| 51   | 7   | 532241474015   | Knob cover grey + line |
| 52   | 1   | 5322 414 74019 | Knob cover grey        |
| 53   | 2   | 532238074089   | Light reflector assy   |
| 54   | 1   | 532229064085   | Soldering support      |
| 55   | 1   | 532225544088   | Led holder             |
| 56   | 1   | 532250514184   | Nut for cal terminal   |

Range indi  
instrument

12.1. MECHANICAL PARTS

| Item | Qty | Order number   | Description            |
|------|-----|----------------|------------------------|
| 1    | 1   | 5322 460 64042 | Side profile left      |
| 2    | 1   | 5322 447 94625 | Side profile right     |
| 3    | 2   | 5322 462 34199 | Print support          |
| 4    | 2   | 5322 528 34113 | Arret for handle       |
| 5    | 2   | 5322 447 94638 | Cover top and bottom   |
| 6    | 1   | 5322 815 22804 | Cil bolt M4X6          |
| 7    | 1   | 4822 505 10488 | Square nut M4          |
| 8    | 1   | 5322 532 14593 | Washer 4. 3X12         |
| 9    | 1   | 4822 530 80077 | Spring washer 52       |
| 10   | 1   | 532281528054   | Cil bolt M3X8          |
| 11   | 1   | 482253210332   | Washer 3. 2X7          |
| 12   | 1   | 482253080173   | Spring washer          |
| 13   | 1   | 532246254154   | CRT shielding          |
| 14   | 1   | 532249264767   | Clamping strip         |
| 15   | 1   | 482250210051   | Cil bolt M4X20         |
| 16   | 1   | 4822 505 10488 | Square nut M4          |
| 17   | 1   | 5322 466 64213 | Plastic profile 30cm   |
| 18   | 1   | 5322 256 64014 | Battery holder         |
| 19   | 1   | 532253594978   | Shaft assy             |
| 20   | 1   | 5322 532 24398 | Coupling               |
| 21   | 2   | 482250210668   | Screw for coupling     |
| 22   | 1   | 532245584091   | Textplate              |
| 23   | 3   | 532241434134   | Knob dia 10            |
| 24   | 3   | 532249264337   | Clamping spring knob   |
| 25   | 9   | 532241434091   | Knob dia 10 shaft 6    |
| 26   | 2   | 532241434249   | Attenuator knob assv   |
| 27   | 1   | 5322 414 34261 | Time/div knob assy     |
| 28   | 3   | 5322 532 54478 | Distance washer        |
| 29   | 2   | 532246244458   | Housing                |
| 30   | 2   | 532246244459   | Cover                  |
| 31   | 2   | 532249254338   | Compression spring     |
| 32   | 2   | 532226814157   | Contact pin            |
| 33   | 1   | 5322 466 85887 | Cover for IEC conn.    |
|      | 1   | 532248034046   | Contrast filter GREY   |
|      | 1   | 532248034074   | Contrast filter BLUE   |
| 37   | 1   | 532246674059   | Bezel                  |
| 38   | 1   | 532248034046   | Contrast filter        |
| 39   | 1   | 5322 447 94169 | Front cover            |
| 40   | 1   | 5322447 94626  | Top cover              |
| 41   | 1   | 532246664214   | Adhesive strip         |
| 42   | 1   | 5322 447 94627 | Bottom cover           |
| 43   | 1   | 532245584092   | Text strip             |
| 44   | 1   | 532249854042   | Aluminium profile      |
| 45   | 1   | 5322 498 54045 | Plastic profile        |
| 46   | 2   | 532253574401   | Locking pin            |
| 47   | 2   | 532249254155   | Compression spring     |
| 48   | 1   | 532249854044   | Bracket left           |
| 49   | 1   | 532249854043   | Bracket right          |
| 50   | 5   | 5322414 74029  | Knob cover blue + line |
| 51   | 7   | 532241474015   | Knob cover grey + line |
| 52   | 1   | 532241474019   | Knob cover grey        |
| 53   | 2   | 532238024089   | Light reflector assy   |
| 54   | 1   | 532229064085   | Soldering support      |
| 55   | 1   | 5322 255 44088 | Led holder             |
| 56   | 1   | 5322 505 14184 | Nut for cal terminal   |

Range indication  
instrument parts.

| Item | Qty | Order number   | Description                        |       |
|------|-----|----------------|------------------------------------|-------|
| 57   | 2   | 532225524015   | Lamp holder                        |       |
| 58   | 4   | 5322 53584447  | Extension part (01 version)        | } S29 |
| 58   | 4   | 532246250215   | Extension part (02 and up)         |       |
| 59   | 4   | 532241425613   | Push button + green (01 version)   |       |
| 59   | 4   | 532241426415   | Push button + green (02 and up)    |       |
| 60   | 1   | 5322 505 14178 | Knurled nut                        |       |
| 61   | 1   | 532246685888   | Locking plate                      |       |
| 62   | 1   | 532253224579   | Bush                               |       |
| 63   | 1   | 5322 532 14697 | Washer                             |       |
| 64   | 1   | 5322 29034022  | Soldering tag                      |       |
| 65   | 1   | 5322 506 14001 | Nut                                |       |
| 66   | 2   | 5322 505 14186 | Nut                                |       |
| 67   | 2   | 532253234124   | Spacer                             |       |
| 68   | 2   | 532253224374   | Coupling R7-R8                     |       |
| 69   | 8   | 532241414011   | Push button grey (01 version)      |       |
| 69   | 8   | 5322 414 25851 | Push button grey (02 and up)       |       |
| 70   | 2   | 532241426019   | Push button L. grey (01 version)   |       |
| 70   | 2   | 532241420002   | Push button L. grey (02 and up)    |       |
| 71   | 35  | 5322 535 84447 | Extension part switch (01 version) |       |
| 71   | 35  | 532246250215   | Extension part switch (02 and up)  |       |
| 72   | 6   | 5322 532 54492 | Paper washer 2.2X5                 |       |
| 73   | 2   | 532227874008   | Arret for switch                   |       |
| 74   | 2   | 532253594966   | Inner shaft                        |       |
| 75   | 1   | 532227874009   | Arret for switch                   |       |
| 76   | 6   | 532225534122   | Lamp holder                        |       |
| 77   | 10  | 532253260487   | Ceramic spacer                     |       |
| 78   | 6   | 532225544218   | IC-FOOT 16 - P DIL                 |       |
|      | 1   | 532225544217   | IC-FOOT 40 - P DIL                 |       |
|      | 4   | 532225544259   | IC-FOOT 20 - P DIL                 |       |
|      | 4   | 532225544109   | IC-FOOT 24 - P DIL                 |       |
|      | 2   | 532225544284   | IC-FOOT 22 - P OIL                 |       |
| 79   | 2   | 482250210692   | CIL BOLT M3X30X19                  |       |
| 80   | 2   | 4822532 10582  | Washer 3.2X9                       |       |
| 81   | 2   | 482253260711   | Insulation bush                    |       |
| 82   | 2   | 532253250488   | Washer 4.3X9                       |       |
| 83   | 2   | 4822532 10582  | Washer 3.2X9                       |       |
| 84   | 2   | 482250510325   | Nut M3                             |       |
| 85   | 2   | 482253210582   | Washer                             |       |
| 86   | 2   | 4822 530 80173 | Spring washer                      |       |
| 87   | 2   | 4822505 10325  | Nut M3                             |       |
| 88   | 1   | 532253224578   | Bushing                            |       |
| 89   | 1   | 4822 530 80173 | Spring washer                      |       |
| 90   | 1   | 4822502 11064  | CIL bolt M3X6                      |       |
| 91   | 2   | 5322 25540029  | Transistor socket                  |       |
| 92   | 1   | 532225640017   | Fuse holder                        |       |
| 93   | 1   | 532232564061   | Cable grommet                      |       |
| 94   | 1   | 532240594046   | Bracket                            |       |
| 95   | 1   | 482250210693   | CIL bolt M4X8                      |       |
| 96   | 1   | 5322321 14066  | Mains cord assy                    |       |
| 97   | 4   | 532246244457   | Foot                               |       |
| 98   | 4   | 532252914067   | Rubber puffer                      |       |
| 99   | 4   | 482250210056   | CIL bolt M4X55                     |       |
| 100  | 4   | 532253214593   | Washer 4.3X12                      |       |

| Item | Qty | Order number   | Description                                     |
|------|-----|----------------|---|
| 101  | 4   | 4822 530 80163 | Spring washer 4.1                               |
| 102  | 4   | 5322 532 24591 | Distance bushing 6X5                            |
| 103  | 8   | 532253224592   | Distance bushing 6X20                           |
| 104  | 1   | 5322 447 94639 | Inner rear plate (01 version)                   |
| 104  |     | 532246680791   | Inner rear plate (02 and up)                    |
| 105  | 6   | 532253224577   | Threaded spacer                                 |
| 106  | 4   | 5322 381 14286 | Window red                                      |
| 107  | 2   | 532253264277   | Holder  |
| 108  | 4   | 5322 532 64278 | Ring  |
| 109  | 2   | 5322532 14696  | Contact ring RANGE INDICATION                   |
| 110  | 2   | 532249264765   | Contact spring PROBE PARTS FIG. 1.11.           |
| 111  | 1   | 5322 447 94652 | Cast. al. front panel                           |
| 112  | 1   | 5322 447 94653 | Cast. al. rear panel                            |
| 113  | 4   | 532246690998   | Spacer for alphanumeric display                 |
| 114  | 25  | 532241425613   | Push button + green (01 version)                |
| 114  | 25  | 532241426415   | Push button + green (02 and up)                 |
| -    | 6   | 532225544207   | Isolation bus for clockdriver D1001 on unit A34 |

FLEXIBLE COUPLINGS

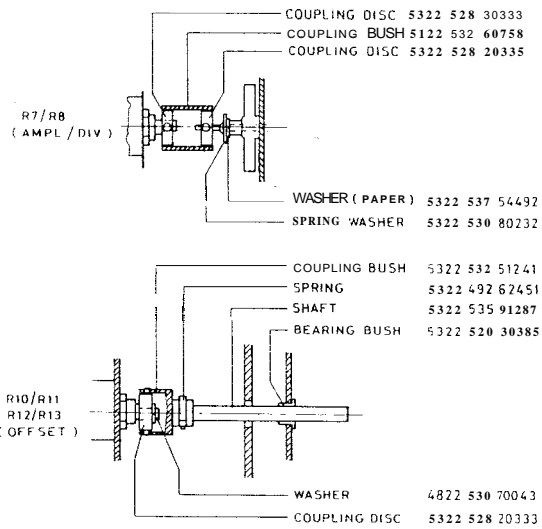

12.2. ELECTRICAL PARTS

| Unit   | Order number   | Description                                |
|--------|----------------|--|
| A101   | 5322 266 21002 | Connector assy                             |
| A2     | 532221654264   | Eront unit ( Per order)                    |
| A201   | 532221654265   | Front board                                |
| A203   | 532221654266   | Interconn board                            |
| A204   | 5322 216 54267 | Display switch board                       |
| A205   | 5322 216 54268 | Save or dl. sw board                       |
| A206   | 532221654269   | Clear switch board                         |
| A207   | 532221654296   | Scale switch board                         |
| A4     | 5322           | Micro proc. unit                           |
| A6     | 5322 216 54273 | Ram unit                                   |
| A7     | 532221654274   | Buffer unit                                |
| 48     | 5322 216 54275 | Conversion unit                            |
| A9     | 532221654276   | ACL unit                                   |
| A10    | 5322           | CCD logic                                  |
| A11    | 5322           | P <sup>2</sup> CCD unit                    |
| A12    | 5322           | Time base unit                             |
| A13    | 532221654281   | Delay trigg. unit                          |
| A15    | 5322 216 54282 | DC-power unit                              |
| A16    | 5322 216 54283 | AC-power unit                              |
| A18    | 532232044053   | Delay line                                 |
| A20    | 532221654284   | Final amplifier unit                       |
| A23    | 5322 218 64116 | Multiplier assy (D3101) ( inclusive cable) |
|        | 5322263 74144  | Extension card                             |
| A401 1 | 5322           | PROM assy.<br>(Set of 3 programmed PROM's) |
| A34    | 5322           | Driver unit                                |

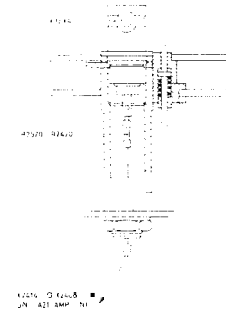

UNIT A101

12.2. ELECTRICAL PARTS

| unit  | Order number   | Description                               |
|-------|----------------|---|
| A101  | 5322 266 21002 | Connector assy.                           |
| A2    | 5322 216 54264 | Front unit (Per order!)                   |
| A201  | 532221654265   | Front board                               |
| A203  | 5322 216 54266 | Interconn board                           |
| A204  | 532221654267   | Display switch hoaro                      |
| A205  | 532221654268   | Save or dl.sw. board                      |
| A206  | 532221654269   | Clear switch hoard                        |
| A207  | 532221654296   | Scale switch board                        |
| A4    | 5322           | Micro proc. unit                          |
| A6    | 532221654273   | Ram unit                                  |
| A7    | 532221654274   | Buffer unit                               |
| A8    | 532221654275   | Conversion unit                           |
| A9    | 5322 216 54276 | ACL unit                                  |
| A10   | 5322           | CCD logic                                 |
| A11   | 5322           | P <sup>2</sup> CCD unit                   |
| 412   | 5322           | Time base unit                            |
| A13   | 5322 216 54281 | Delay trigg. unit                         |
| A15   | 5322 216 54282 | DC power unit                             |
| 416   | 532221654283   | AC power unit                             |
| A18   | 5322 32044053  | Delay line                                |
| A20   | 5322 216 54284 | Final amplifier unit                      |
| A23   | 532221864116   | Multiplier assy (D3101) (inclusive cable) |
|       | 5322 263 74144 | Extension card                            |
| A4011 | 5322           | PROM assy<br>(Set of 3 programmed PROM's) |
| A34   | 5322           | Driver unit                               |

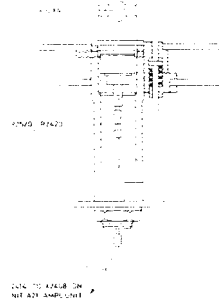

UNIT A101

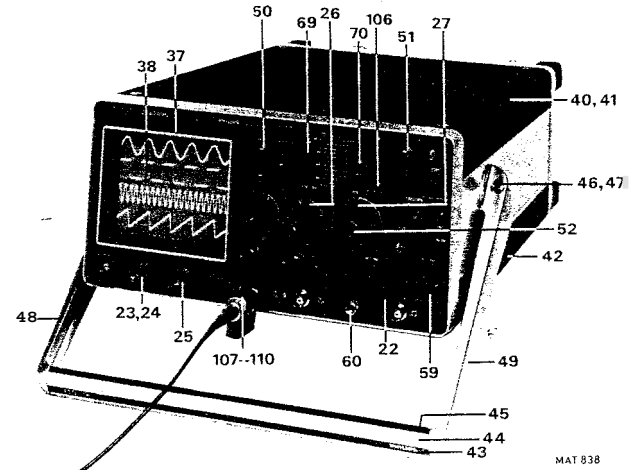

Fig. 12.1.3.

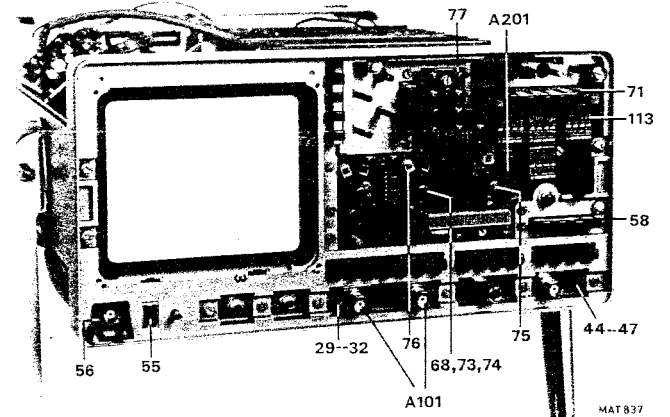

Fig. 12.1.4.

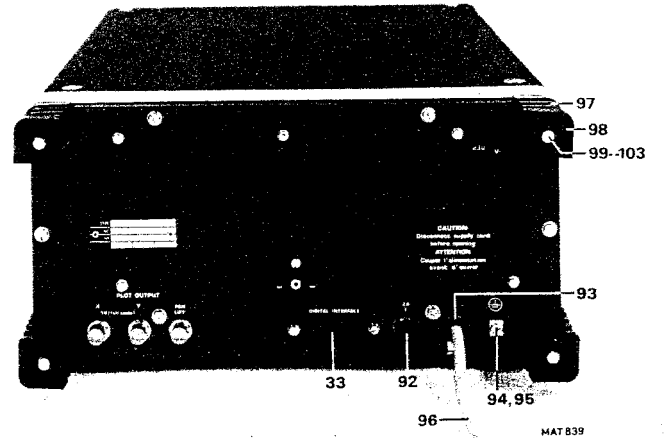

Fig. 12.1.5.





| POSNR  | DESCRIPTION                   | ORDERING CODE      |
|--------|-------------------------------|--------------------|
| C 920  | CAPACITOR, CERAM 220PF 2      | 100 4822 122 31506 |
| C 921  | CAPACITOR, CERAM 10NF-20+50   | 100 4822 122 31414 |
| C 922  | CAPACITOR, CERAM 10NF-20+50   | 100 4822 122 31414 |
| C 923  | CAPACITOR, CERAM 10NF-20+50   | 100 4822 122 31414 |
| C 924  | CAPACITOR, CERAM 10NF-20+50   | 100 4822 122 31414 |
| C 925  | CAPACITOR, CERAM 170PF 10     | 100 4822 122 30034 |
| C 926  | CAPACITOR, CERAM 10NF-20+50   | 100 4822 122 31414 |
| C 927  | CAPACITOR, CERAM 10NF-20+50   | 100 4822 122 31414 |
| C 928  | CAPACITOR, CERAM 10NF-20+50   | 100 4822 122 31414 |
| C 929  | CAP, ELECTROLYT. 330UF-10+50  | 10 4822 124 20684  |
| C 931  | CAPACITOR, CERAM 10NF-20+50   | 100 4822 122 31414 |
| C 932  | CAPACITOR, CERAM 10NF-20+50   | 100 4822 122 31414 |
| C 933  | CAPACITOR, CERAM 10NF-20+50   | 100 4822 122 31414 |
| C 934  | CAPACITOR, CERAM 10NF-20+50   | 100 4822 122 31414 |
| C 1101 | CAP, ELECTROLYT. 33UF-10+50   | 16 4822 124 20688  |
| C 1102 | CAP, ELECTROLYT. 33UF-10+50   | 16 4822 124 20688  |
| C 1103 | CAP, ELECTROLYT. 100NF 10%    | 50V 5322 122 30108 |
| C 1104 | CAP, ELEC. TANTAL 1,5UF 20%   | 35V 5322 124 14078 |
| C 1106 | CAP, ELECTROLYT. 15UF-10+50   | 40 4822 124 20709  |
| C 1107 | CAP, ELECTROLYT. 15UF-10+50   | 40 4822 124 20709  |
| C 1108 | CAPACITOR, CERAM 3,2PF 0,25PF | 100 4822 122 31052 |
| C 1109 | CAPACITOR, CERAM 3,2PF 0,25PF | 100 4822 122 31052 |
| C 1111 | CAPACITOR, CERAM 1NF 10       | 100 6822 122 30027 |
| C 1112 | CAP, ELEC. TANTAL 4,30NF 20%  | 35V 5322 124 14039 |
| C 1113 | CAPACITOR, CERAM 100NF 10%    | 50V 5322 122 30108 |
| C 1114 | CAPACITOR, CERAM 100NF 10%    | 50V 5322 122 30108 |
| C 1116 | CAPACITOR, CERAM 1NF 10       | 100 4822 122-30027 |
| C 1117 | CAP, ELECTROLYT. 15UF-10+50   | 40 4822 124 20709  |
| C 1118 | CAPACITOR, CERAM 100NF 10%    | 50V 5322 122 30108 |
| C 1119 | CAPACITOR, CERAM 100NF 10%    | 50V 5322 122 30108 |
| C 1121 | CAPACITOR, CERAM 100NF 10%    | 50V 5322 122 30108 |
| C 1122 | CAPACITOR, CERAM 220PF 2      | 100 4822 122 31506 |
| C 1123 | CAPACITOR, CERAM 220PF 2      | 100 4822 122 31506 |
| C 1124 | CAP, ELECTROLYT. 15UF-10+50   | 40 4822 124 20709  |
| C 1126 | CAPACITOR, CERAM 1NF 10       | 100 4822 122 30027 |
| C 1128 | CAPACITOR, CERAM 100NF 10%    | 50V 5322 122 30108 |
| C 1129 | CAPACITOR, CERAM 100NF 10%    | 50V 5322 122 30108 |
| C 1131 | CAP, ELEC. TANTAL 6,80NF 20%  | 35V 5322 124 14039 |
| C 1132 | CAPACITOR, CERAM 100NF 10%    | 50V 5322 122 30108 |
| C 1133 | CAP, ELEC. TANTAL 6,8UF 20%   | 25V 5322 124 14081 |
| C 1134 | CAP, ELECTROLYT. 15UF-10+50   | 40 4822 124 20709  |
| C 1136 | CAPACITOR, CERAM 3,2PF 0,25PF | 100 4822 122 31052 |
| C 1137 | CAPACITOR, CERAM 3,2PF 0,25PF | 100 4822 122 31052 |
| C 1138 | CAPACITOR, CERAM 1NF 10       | 100 4822 122 30027 |
| C 1139 | CAP, ELECTROLYT. 15UF-10+50   | 40 4822 124 20709  |
| C 1141 | CAP, ELEC. TANTAL 1,5UF 20%   | 35V 5322 124 14078 |
| C 1142 | CAP, ELEC. TANTAL 1,5UF 20%   | 35V 5322 124 14078 |
| C 1201 | CAPACITOR, CERAM 10NF-20+50   | 100 4822 122 31414 |
| C 1202 | CAPACITOR, CERAM 10NF-20+50   | 100 4822 122 31414 |
| C 1203 | CAPACITOR, CERAM 10NF-20+50   | 100 4822 122 31414 |
| C 1204 | CAPACITOR, CERAM 10NF-20+50   | 100 4822 122 31414 |
| C 1206 | CAPACITOR, CERAM 10NF-20+50   | 100 4822 122 31414 |
| C 1207 | CAPACITOR, CERAM 10NF-20+50   | 100 4822 122 31414 |
| C 1208 | CAPACITOR, CERAM 10NF-20+50   | 100 6822 122 31414 |
| C 1209 | CAPACITOR, CERAM 100NF 10%    | 50V 5322 122 30108 |
| C 1210 | CAPACITOR, CERAM 100NF 10%    | 50V 5322 122 30108 |
| C 1211 | CAPACITOR, CERAM 1NF 10       | 100 4822 122 30027 |
| C 1212 | CAPACITOR, CERAM 3,5PF        | 5322 125 50048     |
| C 1213 | CAPACITOR, TRIMM 47UF-10+50   | 10 4822 124 20678  |
| C 1214 | CAP, ELECTROLYT. 47UF-10+50   | 10 4822 124 20678  |
| C 1216 | CAP, ELECTROLYT. 47UF-10+50   | 10 4822 124 20678  |
| C 1217 | CAPACITOR, CERAM 10NF-20+50   | 100 4822 122 31414 |
| C 1218 | CAPACITOR, CERAM 10NF-20+50   | 100 4822 122 31414 |
| C 1219 | CAPACITOR, CERAM 10NF-20+50   | 100 4822 122 31414 |
| C 1221 | CAPACITOR, CERAM 10NF-20+50   | 100 4822 122 31414 |
| C 1222 | CAPACITOR, CERAM 10NF-20+50   | 100 4822 122 31414 |

| POSNR  | DESCRIPTION                   | ORDERING CODE       |
|--------|-------------------------------|---------------------|
| C 1223 | CAPACITOR, CERAM 10NF-20+50   | 100 4822 122 31414  |
| C 1224 | CAPACITOR, CERAM 10NF-20+50   | 100 4822 122 31414  |
| C 1225 | CAPACITOR, CERAM 100NF 10%    | 50V 5322 122 30108  |
| C 1225 | CAPACITOR, CERAM 10NF-20+50   | 100 4822 122 31414  |
| C 1227 | CAPACITOR, CERAM 100NF 10%    | 50V 5322 122 30108  |
| C 1228 | CAPACITOR, CERAM 10NF-20+50   | 100 4822 122 31414  |
| C 1229 | CAPACITOR, CERAM 10NF-20+50   | 100 4822 122 31414  |
| C 1230 | CAPACITOR, CERAM 100NF 10%    | 50V 5322 122 30108  |
| C 1231 | CAPACITOR, CERAM 100NF 10%    | 50V 5322 122 30108  |
| C 1232 | CAPACITOR, CERAM 100NF 10%    | 50V 5322 122 30108  |
| C 1233 | CAPACITOR, CERAM 100NF 10%    | 50V 5322 122 30108  |
| C 1234 | CAP, ELECTROLYT. 47UF-10+50   | 10 4822 124 20678   |
| C 1235 | CAPACITOR, CERAM 100NF 10%    | 50V 5322 122 30108  |
| C 1236 | CAPACITOR, CERAM 47UF-10+50   | 10 4822 124 20678   |
| C 1237 | CAPACITOR, CERAM 100NF 10%    | 50V 5322 122 30108  |
| C 1238 | CAPACITOR, CERAM 10NF-20+50   | 100 4822 122 31414  |
| C 1239 | CAPACITOR, CERAM 10NF-20+50   | 100 4822 122 31414  |
| C 1301 | CAPACITOR, CERAM 10NF-20+50   | 100 4822 122 31414  |
| C 1302 | CAPACITOR, CERAM 10NF-20+50   | 100 4822 122 31414  |
| C 1303 | CAPACITOR, CERAM 10NF-20+50   | 100 4822 122 31414  |
| C 1304 | CAPACITOR, CERAM 10NF-20+50   | 100 4822 122 31414  |
| C 1306 | CAPACITOR, CERAM 10NF-20+50   | 100 4822 122 31414  |
| C 1307 | CAPACITOR, CERAM 10NF-20+50   | 100 4822 122 31414  |
| C 1308 | CAPACITOR, CERAM 10NF-20+50   | 100 4822 122 31414  |
| C 1309 | CAPACITOR, CERAM 10NF-20+50   | 100 4822 122 31414  |
| C 1311 | CAPACITOR, CERAM 10NF-20+50   | 100 4822 122 31414  |
| C 1312 | CAPACITOR, CERAM 10NF-20+50   | 100 4822 122 31416  |
| C 1313 | CAPACITOR, CERAM 10NF-20+50   | 100 4822 122 31414  |
| C 1314 | CAP, ELECTROLYT. 47UF-10+50   | 10 4822 124 20678   |
| C 1316 | CAP, ELECTROLYT. 47UF-10+50   | 10 4822 124 20678   |
| C 1317 | CAPACITOR, FOIL 1NF 1%        | 630V 4822 121 50591 |
| C 1318 | CAPACITOR, CERAM 10NF-20+50   | 100 4822 122 31414  |
| C 1319 | CAP, ELECTROLYT. 33UF-10+50   | 16 4822 124 20688   |
| C 1321 | CAPACITOR, CERAM 10NF-20+50   | 100 4822 122 31414  |
| C 1322 | CAPACITOR, CERAM 10NF-20+50   | 100 4822 122 31414  |
| C 1323 | CAPACITOR, CERAM 10NF-20+50   | 100 4822 122 31414  |
| C 1324 | CAPACITOR, CERAM 10NF-20+50   | 100 4822 122 31414  |
| C 1326 | CAPACITOR, CERAM 1NF 10       | 100 4822 122 30027  |
| C 1327 | CAPACITOR, FOIL 1NF 1%        | 630V 4822 121 50591 |
| C 1328 | CAPACITOR, FOIL 100NF 10%     | 100V 5322 121 40323 |
| C 1329 | CAP, ELECTROLYT. 33UF-10+50   | 16 4822 124 20688   |
| C 1331 | CAPACITOR, CERAM 10NF-20+50   | 100 4822 122 31521  |
| C 1332 | CAPACITOR, CERAM 10NF-20+50   | 100 4822 122 31414  |
| C 1333 | CAP, ELECTROLYT. 10UF-10+50   | 63 4822 124 20728   |
| C 1334 | CAPACITOR, CERAM 100PF 2      | 100 4822 122 31504  |
| C 1501 | CAPACITOR, PAPER 47NF 10%     | 250V 5322 121 44138 |
| C 1502 | CAPACITOR, FOIL 15NF 10%      | 600V 4822 121 40123 |
| C 1503 | CAPACITOR, FOIL 15NF 10%      | 600V 4822 121 40123 |
| C 1504 | CAPACITOR, HT 470PF 13%       | 2KV 5322 122 54019  |
| C 1506 | CAPACITOR, HT 470PF 20%       | 4KV 5322 122 54004  |
| C 1507 | CAP, ELECTROLYT. 10UF-10+50   | 63 4822 124 20728   |
| C 1508 | CAP, ELECTROLYT. 47UF-10+50   | 63 4822 124 20733   |
| C 1509 | CAP, ELECTROLYT. 330UF-10+50  | 10 4822 124 20684   |
| C 1511 | CAP, ELECTROLYT. 330UF-10+50  | 10 4822 124 20684   |
| C 1512 | CAP, ELECTROLYT. 1000UF-10+50 | 25 4822 124 20786   |
| C 1513 | CAP, ELECTROLYT. 1000UF-10+50 | 25 4822 124 20786   |
| C 1514 | CAPACITOR, CERAM 100PF 2      | 100 4822 122 31504  |
| C 1516 | CAPACITOR, CERAM 100PF 2      | 100 4822 122 31504  |
| C 1517 | CAPACITOR, FOIL 68NF 10%      | 630V 4822 121 40279 |
| C 1518 | CAPACITOR, HT 470PF 10%       | 2KV 5322 122 54019  |
| C 1519 | CAPACITOR, FOIL 478PF 10%     | 630V 4822 121 40279 |
| C 1521 | CAPACITOR, HT 2KV             | 5322 122 54019      |
| C 1522 | CAPACITOR, HT 470PF 10%       | 2KV 5322 122 54019  |
| C 1523 | CAPACITOR, FOIL 150NF 10%     | 400V 5322 121 40307 |
| C 1524 | CAPACITOR, FOIL 150NF 10%     | 400V 5322 121 40307 |

| POSNR  | DESCRIPTION      |              |      | ORDERING CODE  |
|--------|------------------|--------------|------|----------------|
| C 1526 | CAP, ELECTROLYT. | 2200UF-10+50 | 10   | 4822 124 20771 |
| C 1527 | CAP, ELECTROLYT. | 2200UF-10+50 | 10   | 4822 124 20771 |
| C 1528 | CAP, ELECTROLYT. | 33UF-10+50   | 16   | 4822 124 20688 |
| C 1529 | CAPACITOR, FOIL  | 150NF 10%    | 400V | 5322 121 40307 |
| C 1531 | CAPACITOR, FOIL  | 150NF 10%    | 400V | 5322 121 40307 |
| C 1532 | CAPACITOR, FOIL  | 100NF 10%    | 100V | 5322 121 40323 |
| C 1533 | CAP, ELECTROLYT. | 10UF-10+50   | 63   | 4822 124 20728 |
| C 1534 | CAP, ELECTROLYT. | 33UF-10+50   | 16   | 4822 124 20688 |
| C 1536 | CAP, ELECTROLYT. | 47UF-10+50   | 10   | 4822 124 20678 |
| C 1537 | CAPACITOR, FOIL  | 1UF 10%      | 100V | 5322 121 40197 |
| C 1538 | CAPACITOR, FOIL  | 68NF 10%     | 250V | 5322 121 44137 |
| C 1539 | CAPACITOR, CERAM | 10NF-20+50   | 100  | 4822 122 31414 |
| C 1541 | CAPACITOR, FOIL  | 10NF 10%     | 630V | 5322 121 44201 |
| C 1542 | CAPACITOR, FOIL  | 1UF 10%      | 100V | 5322 121 40197 |
| C 1543 | CAPACITOR, FOIL  | 33NF 10%     | 400V | 5322 121 44025 |
| C 1544 | CAPACITOR, CERAM | 12PF 2       | 100  | 4822 122 31056 |
| C 1546 | CAPACITOR, FOIL  | 100NF 10%    | 100V | 5322 121 40323 |
| C 1547 | CAPACITOR, FOIL  | 100NF 10%    | 100V | 4822 121 40231 |
| C 1548 | CAPACITOR, FOIL  | 68NF 10%     | 250V | 5322 121 44137 |
| C 1549 | CAPACITOR, CERAM | 560PF 10     | 100  | 4822 122 30126 |
| C 1551 | CAPACITOR, CERAM | 560PF 10     | 100  | 4822 122 30126 |
| C 1552 | CAP, ELECTROLYT. | 330UF-10+50  | 10   | 4822 124 20684 |
| C 1553 | CAP, ELECTROLYT. | 10UF-10+50   | 63   | 4822 124 20728 |
| C 1554 | CAPACITOR, FOIL  | 100NF 10%    | 100V | 4822 121 40231 |
| C 1555 | CAPACITOR, CERAM | 1NF 10       | 100  | 4822 122 30027 |
| C 1556 | CAPACITOR, CERAM | 20+50        | 100  | 4822 122 31414 |
| C 1557 | CAPACITOR, CERAM | 20+50        | 100  | 4822 122 31414 |
| C 1558 | CAPACITOR, CERAM | 20+50        | 100  | 4822 122 31414 |
| C 1601 | CAPACITOR, FOIL  | 68NF 10%     | 630V | 4822 121 40279 |
| C 1602 | CAPACITOR, FOIL  |              |      | 5322 121 44333 |
| C 1603 | CAPACITOR, FOIL  |              |      | 5322 121 44333 |
| C 1604 | CAP, ELECTROLYT. | 220UF-10+50  | 350  | 5322 124 44007 |
| C 1606 | CAP, ELECTROLYT. | 220UF-10+50  | 350  | 5322 124 44007 |
| C 1607 | CAPACITOR, HT    | 270PF 10%    | 2KV  | 5322 122 54024 |
| C 1608 | CAPACITOR, PAPER | 220NF 10%    | 250V | 5322 121 44142 |
| C 1609 | CAP, ELECTROLYT. | 10UF-10+50   | 63   | 4822 124 20728 |
| C 1610 | CAPACITOR, CERAM | 1.8NF 10     | 100  | 4822 122 30048 |
| C 1611 | CAP, ELECTROLYT. | 10UF-10+50   | 63   | 4822 124 20728 |
| C 1612 | CAPACITOR, FOIL  | 220NF 10%    | 100V | 4822 121 40232 |
| C 1613 | CAPACITOR, FOIL  | 22NF 10%     | 400V | 5322 121 44232 |
| C 1614 | CAPACITOR, FOIL  | 22NF 10%     | 400V | 5322 121 44232 |
| C 1616 | CAPACITOR, FOIL  | 100NF 10%    | 100V | 5322 121 40323 |
| C 1617 | CAPACITOR, CERAM | 2.2NF 10     | 100  | 4822 122 30114 |
| C 1618 | CAPACITOR, FOIL  | 68NF 10%     | 250V | 5322 121 44137 |
| C 1619 | CAPACITOR, FOIL  | 3.32NF 1%    | 63V  | 4822 121 50654 |
| C 1620 | CAPACITOR, HT    | 470PF 10%    | 2KV  | 5322 122 54019 |
| C 1621 | CAP, ELECTROLYT. | 10UF-10+50   | 63   | 4822 124 20728 |
| C 1622 | CAP, ELECTROLYT. | 22UF-10+50   | 25   | 4822 124 20698 |
| C 1623 | CAP, ELECTROLYT. | 22UF-10+50   | 25   | 4822 124 20698 |
| C 1624 | CAPACITOR, CERAM | 1NF 10       | 100  | 4822 122 30027 |
| C 1625 | CAPACITOR, HT    | 470PF 10%    | 2KV  | 5322 122 54019 |
| C 1701 | CAPACITOR, FOIL  | 100NF 10%    | 250V | 4822 121 40036 |
| C 1702 | CAPACITOR, FOIL  | 100NF 10%    | 250V | 4822 121 40036 |
| C 200  | CAP, ELECTROLYT. | 47UF-10+50   | 10   | 4822 124 20678 |
| C 2001 | CAPACITOR, CERAM | 10NF-20+50   | 100  | 4822 122 31414 |
| C 2002 | CAPACITOR, CERAM | 10NF-20+50   | 100  | 4822 122 31414 |
| C 2003 | CAPACITOR, CERAM | 10NF-20+50   | 100  | 4822 122 31414 |
| C 2004 | CAPACITOR, CERAM | 10NF-20+50   | 100  | 4822 122 31414 |
| C 2006 | CAPACITOR, CERAM | 10NF-20+50   | 100  | 4822 122 31414 |
| C 2007 | CAPACITOR, FOIL  | 1NF 1%       | 630V | 4822 121 50591 |
| C 2008 | CAPACITOR, CERAM | 220PF 2      | 100  | 4822 122 31506 |
| C 2009 | CAPACITOR, CERAM | 10NF-20+50   | 100  | 4822 122 31414 |
| C 201  | CAPACITOR, CERAM | 10NF-20+50   | 100  | 4822 122 31414 |
| C 2011 | CAPACITOR, CERAM | 10NF-20+50   | 100  | 4822 122 31414 |
| C 2012 | CAPACITOR, CERAM | 10NF-20+50   | 100  | 4822 122 31414 |

| POSNR  | DESCRIPTION      |              |      | ORDERING CODE  |
|--------|------------------|--------------|------|----------------|
| C 2013 | CAPACITOR, CERAM | 10NF-20+50   | 100  | 4822 122 31414 |
| C 2014 | CAPACITOR, FOIL  |              |      | 5322 121 54229 |
| C 2016 | CAPACITOR, CERAM | 10NF-20      | 100  | 4822 122 31414 |
| C 2017 | CAPACITOR, CERAM | 10NF-20      | 100  | 4822 122 31414 |
| C 2018 | CAPACITOR, CERAM | 10NF-20      | 100  | 4822 122 31414 |
| C 2019 | CAPACITOR, CERAM | 10NF-20+50   | 100  | 4822 122 31414 |
| C 202  | CAPACITOR, CERAM | 10NF-20+50   | 100  | 4822 122 31414 |
| C 2021 | CAPACITOR, CERAM | 10NF-20+50   | 100  | 4822 122 31414 |
| C 2022 | CAPACITOR, CERAM | 10NF-20+50   | 100  | 4822 122 31414 |
| C 2023 | CAPACITOR, CERAM | 10NF 20+50   | 100  | 4822 122 31414 |
| C 2024 | CAPACITOR, CERAM | 10NF-20+50   |      |                |
| C 2026 | CAPACITOR, CERAM | 10NF-20+50   | 100  | 4822 122 31414 |
| C 2027 | CAPACITOR, FOIL  |              |      | 5322 121 54229 |
| C 2028 | CAPACITOR, FOIL  |              |      | 5322 121 54229 |
| C 2029 | CAPACITOR, CERAM | 10NF-20+50   | 100  | 4822 122 31414 |
| C 203  | CAPACITOR, CERAM | 10NF-20+50   | 100  | 4822 122 31414 |
| C 2030 | CAPACITOR, CERAM | 82PF 2       | 100  | 5322 122 31577 |
| C 2031 | CAPACITOR, CERAM | 10NF-20+50   | 100  | 4822 122 31414 |
| C 2032 | CAPACITOR, CERAM | 10NF-20+50   | 100  | 4822 122 31414 |
| C 2033 | CAPACITOR, FOIL  | 68NF 10%     | 250V | 5322 121 44137 |
| C 2034 | CAPACITOR, CERAM | 10NF-20+50   | 100  | 4822 122 31414 |
| C 2036 | CAP, ELECTROLYT. | 33UF-10+50   | 16   | 4822 124 20688 |
| C 2037 | CAP, ELECTROLYT. | 33UF-10+50   |      |                |
| C 2038 | CAPACITOR, FOIL  | 220NF 10%    | 100V | 4822 124 20688 |
| C 2039 | CAPACITOR, FOIL  | 68NF 10%     | 250V | 5322 121 44137 |
| C 204  | CAPACITOR, CERAM | 10NF-20+50   | 100  | 4822 122 31414 |
| C 2041 | CAPACITOR, FOIL  |              |      | 5322 121 54229 |
| C 2042 | CAPACITOR, CERAM | 10NF-20+50   | 100  | 4822 122 31414 |
| C 2043 | CAPACITOR, MIL   |              |      | 5322 121 54229 |
| C 206  | CAPACITOR, CERAM | 10NF-20+50   | 100  | 4822 122 31414 |
| C 207  | , ELECTROLYT.    | 47UF-10+50   | 10   | 4822 124 20678 |
| C 2400 | , ELECTROLYT.    | 48NF-20+50   |      |                |
| C 2401 | ACITOR, CERAM    |              | 100  | 4822 122 30476 |
| C 2402 | CAPACITOR, CERAM | 10NF-20+50   | 100  | 4822 122 31414 |
| C 2403 | CAPACITOR, CERAM | 10NF-20+50   | 100  | 4822 122 31414 |
| C 2404 | CAPACITOR, CERAM | 10NF-20+50   | 100  | 4822 122 31414 |
| C 2405 | CAPACITOR, CERAM | 1.5PF 0.25PF |      |                |
| C 2406 | CAPACITOR, CERAM | 10NF-20+50   | 100  | 4822 122 30105 |
| C 2407 | CAPACITOR, CERAM | 28NF-20+50   | 100  | 4822 122 31063 |
| C 2408 | CAPACITOR, CERAM |              | 100  | 4822 122 31414 |
| C 2409 | CAPACITOR, TRIMM | 5.5PF        |      |                |
| C 241  | CAPACITOR, CERAM | 10NF-20+50   | 100  | 4822 122 54024 |
| C 2410 | CAPACITOR, CERAM | 3.9PF 0.25PF | 500  | 4822 122 31217 |
| C 2411 | CAPACITOR, CERAM | 10NF-20+50   | 100  | 4822 122 31414 |
| C 2412 | CAPACITOR, CERAM | 10NF-20+50   | 100  | 4822 122 31414 |
| C 2413 | CAP, FEEDTROUGH  | 300PF 10     | 300  | 5322 123 10168 |
| C 2414 | CAPACITOR, FOIL  | 22NF 10%     | 250V | 4822 121 40407 |
| C 2415 | CAPACITOR, CERAM | 10NF-20+50   | 100  | 4822 122 31414 |
| C 2416 | CAPACITOR, TRIMM | 3PF          |      |                |
| C 2417 | CAPACITOR, CERAM | 10NF-20+50   | 100  | 4822 123 54024 |
| C 2418 | CAPAC TOR, CERAM | 10NF-20+50   | 100  | 4822 122 31414 |
| C 2419 | CAPAC TOR, CERAM | 10NF-20+50   | 100  | 4822 122 31414 |
| C 242  | CAPAC TOR, CERAM | 10NF-20+50   | 100  | 4822 122 31414 |
| C 2420 | CAPAC TOR, CERAM | 10NF-20+50   | 100  | 4822 122 31414 |
| C 2421 | CAPACITOR, CERAM | 10NF-20+50   | 100  | 4822 122 31414 |
| C 2422 | CAPACITOR, CERAM | 10NF-20+50   | 100  | 4822 122 31414 |
| C 2423 | CAPACITOR, CERAM | 39PF 2       | 100  | 4822 122 31069 |
| C 2424 | CAPACITOR, TRIMM | 2.0-18P TRIM |      | 5322 125 50051 |
| C 2425 | CAPACITOR, CERAM | 10NF-20+50   | 100  | 4822 122 31414 |
| C 2426 | CAPACITOR, CERAM | 10NF-20+50   | 100  | 4822 122 31414 |
| C 427  | CAPACITOR TRIMM  | 5.5F         |      | 5322 125 54027 |
| C 428  | CAPACITOR CERAM  | 60PF 10      | 500  | 4822 122 31166 |
| C 429  | CAPACITOR, CERAM | 10NF-        | 100  | 4822 122 31414 |
| C 43   | CAPACITOR, CERAM | 10NF-        | 100  | 4822 122 31414 |
| C 2430 | CAPACITOR, CERAM | 470PF 10     | 100  | 4822 122 30034 |

| POSNR  | DESCRIPTION      |              |      | ORDERING CODE  |
|--------|------------------|--------------|------|----------------|
| C 2431 | CAPACITOR, CERAM | 68PF 2       | 500  | 4822 122 31207 |
| C 2432 | CAPACITOR, CERAM | 10NF-20+50   | 100  | 4822 122 31414 |
| C 2433 | CAPACITOR, CERAM | 10NF-20+50   | 100  | 4822 122 31414 |
| C 2434 | CAPACITOR, CERAM | 10NF-20+50   | 100  | 4822 122 31414 |
| C 2435 | CAPACITOR, CERAM | 10NF-20+50   | 100  | 4822 122 31414 |
| C 2436 | CAPACITOR, CERAM | 1NF 10       | 100  | 4822 122 30027 |
| C 2437 | CAPACITOR, CERAM | 1,5PF 0,25PF | 100  | 4822 122 30105 |
| C 2438 | CAPACITOR, CERAM | 10NF-20+50   | 100  | 4822 122 31414 |
| C 2439 | CAPACITOR, CERAM | 39PF 2       | 100  | 4822 122 31069 |
| C 244  | CAPACITOR, CERAM | 10NF-20+50   | 100  | 4822 122 31414 |
| C 2440 | CAPACITOR, CERAM | 10NF-20+50   | 100  | 4822 122 31414 |
| C 2441 | CAPACITOR, CERAM | 39PF 2       | 100  | 4822 122 31069 |
| C 2442 | CAPACITOR, TRIMM | 5,5PF        | 5322 | 125 54027      |
| C 2443 | CAP, FEEDTROUGH  | 30PF 10      | 300  | 5322 123 34001 |
| C 2444 | CAPACITOR, TRIMM | 3PF          | 5322 | 125 54026      |
| C 2445 | CAPACITOR, CERAM | 3,9PF 0,25PF | 500  | 4822 122 31217 |
| C 2446 | CAPACITOR, CERAM | 470PF 10     | 100  | 4822 122 30034 |
| C 2447 | CAPACITOR, TRIMM | 2,0-18P TRIM | 5322 | 125 50051      |
| C 2448 | CAPACITOR, CERAM | 10NF-20+50   | 100  | 4822 122 31414 |
| C 2449 | CAPACITOR, CERAM | 2,2PF 0,25PF | 100  | 4822 122 31036 |
| C 2450 | CAPACITOR, CERAM | 2,2PF 0,25PF | 100  | 4822 122 31036 |
| C 2451 | CAPACITOR, CERAM | 10NF-20+50   | 100  | 4822 122 31414 |
| C 2452 | CAPACITOR, CERAM | 10NF-20+50   | 100  | 4822 122 31414 |
| C 2453 | CAPACITOR, CERAM | 10NF-20+50   | 100  | 4822 122 31414 |
| C 2454 | CAPACITOR, CERAM | 10PF 2       | 100  | 4822 122 31054 |
| C 2455 | CAPACITOR, CERAM | 10NF-20+50   | 100  | 4822 122 31414 |
| C 2456 | CAPACITOR, CERAM | 39PF 2       | 100  | 4822 122 31069 |
| C 2457 | CAPACITOR, CERAM | 10NF-20+50   | 100  | 4822 122 31414 |
| C 2458 | CAPACITOR, CERAM | 10NF-20+50   | 100  | 4822 122 31414 |
| C 2459 | CAPACITOR, CERAM | 22PF 2       | 100  | 4822 122 31063 |
| C 246  | CAPACITOR, CERAM | 10NF-20+50   | 100  | 4822 122 31414 |
| C 2460 | CAPACITOR, CERAM | 10NF-20+50   | 100  | 4822 122 31414 |
| C 2461 | CAPACITOR, CERAM | 10NF-20+50   | 100  | 4822 122 31414 |
| C 2462 | CAPACITOR, CERAM | 10NF-20+50   | 100  | 4822 122 31414 |
| C 2463 | CAPACITOR, CERAM | 10NF-20+50   | 100  | 4822 122 31414 |
| C 2464 | CAPACITOR, CERAM | 10NF-20+50   | 100  | 4822 122 31414 |
| C 2465 | CAPACITOR, CERAM | 10NF-20+50   | 100  | 4822 122 31414 |
| C 2466 | CAPACITOR, CERAM | 10NF-20+50   | 100  | 4822 122 31414 |
| C 2467 | CAPACITOR, CERAM | 100NF 10%    | 100V | 5322 121 40323 |
| C 2468 | CAPACITOR, CERAM | 10NF-20+50   | 100  | 4822 122 31414 |
| C 2469 | CAPACITOR, CERAM | 10NF-20+50   | 100  | 4822 122 31414 |
| C 247  | CAPACITOR, CERAM | 10NF-20+50   | 100  | 4822 122 31414 |
| C 2470 | CAPACITOR, CERAM | 1,5PF 0,25PF | 100  | 4822 122 30105 |
| C 2471 | CAPACITOR, CERAM | 10NF-20+50   | 100  | 4822 122 31414 |
| C 2472 | CAPACITOR, CERAM | 10NF-20+50   | 100  | 4822 122 31414 |
| C 2473 | CAPACITOR, CERAM | 22PF 2       | 100  | 4822 122 31063 |
| C 2474 | CAPACITOR, CERAM | 10NF-20+50   | 100  | 4822 122 31414 |
| C 2475 | CAPACITOR, CERAM | 3,9PF 0,25PF | 500  | 4822 122 31217 |
| C 2476 | CAPACITOR, FOIL  | 22NF 10%     | 250V | 4822 121 40407 |
| C 2477 | CAPACITOR, TRIMM | 5,5PF        | 5322 | 125 54027      |
| C 2478 | CAPACITOR, CERAM | 10NF-20+50   | 100  | 4822 122 31414 |
| C 2479 | CAPACITOR, CERAM | 10NF-20+50   | 100  | 4822 122 31414 |
| C 248  | CAPACITOR, CERAM | 10NF-20+50   | 100  | 4822 122 31414 |
| C 2480 | CAPACITOR, CERAM | 10NF-20+50   | 100  | 4822 122 31414 |
| C 2481 | CAPACITOR, CERAM | 10NF-20+50   | 100  | 4822 122 31414 |
| C 2482 | CAPACITOR, CERAM | 10NF-20+50   | 100  | 4822 122 31414 |
| C 2483 | CAF FEEDTROUGH   | 300PF 10     | 300  | 5322 123 10168 |
| C 2484 | CAF FEEDTROUGH   | 3PF          | 5322 | 125 54026      |
| C 2485 | CAPACITOR, CERAM | 10NF-20+50   | 100  | 4822 122 31414 |
| C 2486 | CAPACITOR, CERAM | 10NF-20+50   | 100  | 4822 122 31414 |
| C 2487 | CAPACITOR, CERAM | 10NF-20+50   | 100  | 4822 122 31414 |
| C 2488 | CAPACITOR, CERAM | 10NF-20+50   | 100  | 4822 122 31614 |
| C 2489 | CAPACITOR, CERAM | 10NF-20+50   | 100  | 4822 122 31414 |
| C 249  | CAPACITOR, CERAM | 10NF-20+50   | 100  | 4822 122 31414 |
| C 2490 | CAPACITOR, CERAM | 39PF 2       | 100  | 4822 122 31069 |

| POSNR  | DESCRIPTION      |              |      | ORDERING CODE  |
|--------|------------------|--------------|------|----------------|
| C 2491 | CAPACITOR, CERAM | 10NF-20+50   | 100  | 4822 122 31414 |
| C 2492 | CAPACITOR, CERAM | 10NF-20+50   | 100  | 4822 122 31414 |
| C 2493 | CAPACITOR, CERAM | 10NF-20+50   | 100  | 4822 122 31414 |
| C 2494 | CAPACITOR, CERAM | 1NF 10       | 100  | 4822 122 30027 |
| C 2495 | CAPACITOR, CERAM | 10NF-20+50   | 100  | 4822 122 31414 |
| C 2496 | CAPACITOR, TRIMM | 2,0-18P TRIM | 5322 | 125 50051      |
| C 2497 | CAPACITOR, CERAM | 10NF-20+50   | 100  | 4822 122 31414 |
| C 2498 | CAPACITOR, CERAM | 10NF-20+50   | 100  | 4822 122 31414 |
| C 2499 | CAPACITOR, CERAM | 22PF 2       | 100  | 4822 122 31063 |
| C 2501 | CAP, ELECTROLYT. | 220UF-10+50  | 16   | 4822 124 20693 |
| C 2502 | CAP, ELECTROLYT. | 220UF-10+50  | 16   | 4822 124 20693 |
| C 2503 | CAPACITOR, TRIMM | 5,5PF        | 5322 | 125 54027      |
| C 2504 | CAPACITOR, CERAM | 560PF 10     | 500  | 4822 122 31166 |
| C 2506 | CAPACITOR, CERAM | 10NF-20+50   | 100  | 4822 122 31414 |
| C 2507 | CAPACITOR, CERAM | 68PF 2       | 500  | 4822 122 31207 |
| C 2508 | CAPACITOR, CERAM | 10NF-20+50   | 100  | 4822 122 31414 |
| C 2509 | CAPACITOR, CERAM | 10NF-20+50   | 100  | 4822 122 31414 |
| C 251  | CAPACITOR, CERAM | 10NF-20+50   | 100  | 4822 122 31414 |
| C 2510 | CAPACITOR, CERAM | 470PF 10     | 100  | 4822 122 30034 |
| C 2511 | CAPACITOR, CERAM | 10NF-20+50   | 100  | 4822 122 31414 |
| C 2512 | CAPACITOR, CERAM | 1NF 10       | 100  | 4822 122 30027 |
| C 2513 | CAPACITOR, CERAM | 1,5PF 0,25PF | 100  | 4822 122 30105 |
| C 2514 | CAPACITOR, CERAM | 10NF-20+50   | 100  | 4822 122 31414 |
| C 2515 | CAPACITOR, CERAM | 3,9PF 0,25PF | 500  | 4822 122 31217 |
| C 2516 | CAPACITOR, CERAM | 39PF 2       | 100  | 4822 122 31069 |
| C 2517 | CAPACITOR, CERAM | 39PF 2       | 100  | 4822 122 31069 |
| C 2518 | CAPACITOR, TRIMM | 5,5PF        | 5322 | 125 54027      |
| C 2519 | CAP, FEEDTROUGH  | 30PF 10      | 300  | 5322 123 34001 |
| C 252  | CAP, ELECTROLYT. | 330UF-10+50  | 10   | 4822 124 20684 |
| C 2520 | CAPACITOR, CERAM | 10NF-20+50   | 100  | 4822 122 31414 |
| C 2521 | CAPACITOR, TRIMM | 3PF          | 5322 | 125 54026      |
| C 2522 | CAPACITOR, CERAM | 470PF 10     | 100  | 4822 122 30034 |
| C 2523 | CAPACITOR, TRIMM | 2,0-18P TRIM | 5322 | 125 50051      |
| C 2524 | CAPACITOR, CERAM | 10NF-20+50   | 100  | 4822 122 31414 |
| C 2525 | CAPACITOR, CERAM | 10NF-20+50   | 100  | 4822 122 31414 |
| C 2526 | CAPACITOR, CERAM | 10NF-20+50   | 100  | 4822 122 31414 |
| C 2527 | CAPACITOR, CERAM | 10NF-20+50   | 100  | 4822 122 31414 |
| C 2528 | CAPACITOR, CERAM | 10PF 2       | 100  | 4822 122 31054 |
| C 2529 | CAPACITOR, CERAM | 10NF-20+50   | 100  | 4822 122 31054 |
| C 253  | CAP, ELECTROLYT. | 47UF-10+50   | 10   | 4822 124 20678 |
| C 253C | CAPACITOR, CERAM | 10NF-20+50   | 100  | 4822 122 31414 |
| C 2531 | CAPACITOR, CERAM | 10NF-20+50   | 100  | 4822 122 31063 |
| C 2532 | CAPACITOR, CERAM | 22PF 2       | 100  | 4822 122 31414 |
| C 2533 | CAPACITOR, CERAM | 10NF-20+50   | 100  | 4822 122 31414 |
| C 2534 | CAPACITOR, CERAM | 10NF-20+50   | 100  | 4822 122 31414 |
| C 2535 | CAP, ELECTROLYT. | 15UF 10%     | 16V  | 4822 124 20977 |
| C 2536 | CAPACITOR, CERAM | 10NF-20+50   | 100  | 4822 122 31414 |
| C 2537 | CAPACITOR, CERAM | 10NF-20+50   | 100  | 4822 122 31414 |
| C 2538 | CAPACITOR, CERAM | 10NF-20+50   | 100  | 4822 122 31414 |
| C 2539 | CAP, ELECTROLYT. | 220UF-10+50  | 16   | 4822 124 20693 |
| C 254  | CAPACITOR, CERAM | 10NF-20+50   | 100  | 4822 122 31414 |
| C 2540 | CAP, ELECTROLYT. | 680UF-10+50  | 100  | 4822 122 30778 |
| C 2541 | CAPACITOR, CERAM | 10NF-20+50   | 100  | 4822 122 31414 |
| C 2542 | CAPACITOR, CERAM | 10NF-20+50   | 100  | 4822 122 31414 |
| C 2543 | CAP, ELECTROLYT. | 220UF-10+50  | 16   | 4822 124 20693 |
| C 2544 | CAPACITOR, CERAM | 10NF-20+50   | 100  | 4822 122 31414 |
| C 2545 | CAP, ELECTROLYT. | 100UF-10+50  | 10   | 4822 124 20679 |
| C 2546 | CAPACITOR, CERAM | 10NF-20+50   | 100  | 4822 122 31414 |
| C 2547 | CAPACITOR, CERAM | 10NF-20+50   | 100  | 4822 122 31414 |
| C 2548 | CAPACITOR, CERAM | 10NF-20+50   | 100  | 4822 122 31414 |
| C 2549 | CAP, ELECTROLYT. | 100UF-10+50  | 10   | 4822 124 20679 |
| C 2550 | CAP, ELECTROLYT. | 488UF-20+50  | 10   | 4822 124 20678 |
| C 2551 | CAPACITOR, CERAM | 10NF-20+50   | 100  | 4822 122 31414 |
| C 2552 | CAPACITOR, CERAM | 10NF-20+50   | 100  | 4822 122 31414 |
| C 2553 | CAPACITOR, CERAM | 10NF-20+50   | 100  | 4822 122 31414 |

| POSNR  | DESCRIPTION      |                | ORDERING | CODE           |
|--------|------------------|----------------|----------|----------------|
| C 2554 | CAPACITOR, CERAM | 10NF-20+50     | 100      | 4822 122 31414 |
| C 2556 | CAPACITOR, CERAM | 10NF-20+50     | 100      | 4822 122 31414 |
| C 2557 | CAPACITOR, CERAM | 10NF-20+50     | 100      | 4822 122 31414 |
| C 2558 | CAPACITOR, CERAM | 10NF-20+50     | 100      | 4822 122 31414 |
| C 2559 | CAPACITOR, CERAM | 10NF-20+50     | 100      | 4822 122 31414 |
| C 256  | CAP, ELECTROLYT. | 33UF-10+50     | 16       | 4822 124 20688 |
| C 2561 | CAPACITOR, CERAM | 10NF-20+50     | 100      | 4822 122 31414 |
| C 2562 | CAPACITOR, CERAM | 10NF-20+50     | 100      | 4822 122 31414 |
| C 2563 | CAPACITOR, CERAM | 10NF-20+50     | 100      | 4822 122 31414 |
| C 2564 | CAPACITOR, CERAM | 10NF-20+50     | 100      | 4822 122 31414 |
| C 2566 | CAPACITOR, CERAM | 10NF-20+50     | 100      | 4822 122 31414 |
| C 2567 | CAPACITOR, CERAM | 10NF-20+50     | 100      | 4822 122 31414 |
| C 2568 | CAP, ELECTROLYT. | 3, 3UF 40%     | 16V      | 4822 124 20947 |
| C 2569 | CAPACITOR, CERAM | 10NF-20+50     | 100      | 4822 122 31414 |
| C 257  | CAP, ELECTROLYT. | 33UF-10+50     | 16       | 4822 124 20688 |
| C 2570 | CAPACITOR, CERAM | 10NF-20+50     | 100      | 4822 122 31414 |
| C 2571 | CAPACITOR, CERAM | 10NF-20+50     | 100      | 4822 122 31414 |
| C 2572 | CAPACITOR, CERAM | 10NF-20+50     | 100      | 4822 122 31414 |
| C 2573 | CAPACITOR, CERAM | 10NF-20+50     | 100      | 4822 122 31414 |
| C 2574 | CAPACITOR, CERAM | 10NF-20+50     | 100      | 4822 122 31414 |
| C 2575 | CAPACITOR, CERAM | 10NF-20+50     | 100      | 4822 122 31429 |
| C 2576 | CAPACITOR, CERAM | 10NF-20+50     | 100      | 4822 122 31429 |
| C 2577 | CAPACITOR CERAM  | 2, 2NF 10      | 100      | 4822 122 30114 |
| C 2578 | CAPACITOR CERAM  | 2, 2NF 10      | 100      | 4822 122 30114 |
| C 2579 | CAPACITOR CERAM  | 2, 2NF 10      | 100      | 4822 122 30114 |
| C 258  | CAP, ELECTROLYT. | 33UF-10+50     | 16       | 4822 124 20688 |
| C 2580 | CAPACITOR, CERAM | 2, 2NF 10      | 100      | 4822 122 30114 |
| C 2581 | CAPACITOR, CERAM | 1, 8PF 0, 25PF | 100      | 4822 122 30105 |
| C 2585 | CAPACITOR, CERAM | 6, 8PF 0, 25PF | 100      | 4822 122 31049 |
| C 2586 | CAPACITOR, CERAM | 6, 8PF 0, 25PF | 100      | 4822 122 31049 |
| C 2587 | CAPACITOR, CERAM | 10NF-20+50     | 100      | 4822 122 31414 |
| C 2588 | CAPACITOR, CERAM | 10NF-20+50     | 100      | 4822 122 31414 |
| C 2589 | CAPACITOR, CERAM | 10NF-20+50     | 100      | 4822 122 31414 |
| C 2590 | CAPACITOR, CERAM | 10NF-20+50     | 100      | 4822 122 31414 |
| C 2591 | CAP, ELECTROLYT. | 47UF-10+50     | 10       | 4822 124 20678 |
| C 2593 | CAPACITOR, CERAM | 10NF-20+50     | 100      | 4822 122 31414 |
| C 2594 | CAPACITOR, CERAM | 10NF-20+50     | 100      | 4822 122 31414 |
| C 2595 | CAPACITOR, CERAM | 10NF-20+50     | 100      | 4822 122 31429 |
| C 2596 | CAPACITOR, CERAM | 10NF-20+50     | 100      | 4822 122 31414 |
| C 2597 | CAPACITOR, CERAM | 10NF-20+50     | 100      | 4822 122 31414 |
| C 2598 | CAPACITOR, CERAM | 10NF-20+50     | 100      | 4822 122 31414 |
| C 2599 | CAPACITOR, CERAM | 10NF-20+50     | 100      | 4822 122 31414 |
| C 2600 | CAPACITOR, CERAM | 10NF-20+50     | 100      | 4822 122 31414 |
| C 2601 | CAPACITOR, CERAM | 10NF-20+50     | 100      | 4822 122 31414 |
| C 2602 | CAP, ELECTROLYT. | 33UF-10+50     | 16       | 4822 124 20688 |
| C 2603 | CAPACITOR, CERAM | 10NF-20+50     | 100      | 4822 122 31414 |
| C 2604 | CAPACITOR, CERAM | 10NF-20+50     | 100      | 4822 122 31414 |
| C 2605 | CAPACITOR, CERAM | 10NF-20+50     | 100      | 4822 122 31429 |
| C 2606 | CAPACITOR, CERAM | 10NF-20+50     | 100      | 4822 122 31414 |
| C 2701 | CAPACITOR, CERAM | 10NF-20+50     | 100      | 4822 122 31414 |
| C 2702 | CAPACITOR, CERAM | 10NF-20+50     | 100      | 4822 122 31414 |
| C 2703 | CAP, ELECTROLYT. | 47UF-10+50     | 10       | 4822 124 20678 |
| C 2704 | CAPACITOR, CERAM | 82PF 2         | 100      | 4822 122 31243 |
| C 2705 | CAPACITOR, CERAM | 10NF-20+50     | 100      | 4822 122 31414 |
| C 2706 | CAPACITOR, CERAM | 3, 2PF 0, 25PF | 500      | 4822 122 31194 |
| C 2707 | CAPACITOR, CERAM | 6, 8PF 0, 25PF | 500      | 4822 122 31192 |
| C 2708 | CAPACITOR, CERAM | 100PF 2        | 500      | 5322 122 31626 |
| C 2709 | CAP, ELECTROLYT. | 4, 7UF-10+50   | 63       | 5322 124 24211 |
| C 2710 | CAP, ELECTROLYT. | 33UF-10+50     | 16       | 4822 124 20688 |
| C 2711 | CAPACITOR, FOIL  | 220NF 10%      | 100V     | 4822 121 40232 |
| C 2712 | CAP, ELECTROLYT. | 33UF-10+50     | 16       | 4822 124 20688 |
| C 2713 | CAPACITOR, CERAM | 10NF-20+50     | 100      | 4822 122 31414 |
| C 2714 | CAPACITOR, CERAM | 4, 7NF 10      | 100      | 4822 122 30128 |
| C 2715 | CAPACITOR, CERAM | 15PF 2         | 100      | 4822 122 31058 |
| C 2716 | CAPACITOR, CERAM | 1NF 10         | 100      | 4822 122 30007 |

| POSNR  | DESCRIPTION      |                | ORDERING | CODE           |
|--------|------------------|----------------|----------|----------------|
| C 2717 | CAPACITOR, CERAM | 10NF-20+50     | 100      | 4822 122 31414 |
| C 2718 | CAPACITOR, CERAM | 68PF 2         | 100      | 4822 122 31349 |
| C 2719 | CAPACITOR, FOIL  | 22NF 10%       | 400V     | 5322 121 44232 |
| C 2721 | CAPACITOR, CERAM | 180PF 2        | 100      | 5322 122 34144 |
| C 2722 | CAP, ELECTROLYT. | 47UF-10+50     | 10       | 4822 124 20678 |
| C 2723 | CAP, ELECTROLYT. | 33UF-10+50     | 16       | 4822 124 20688 |
| C 2724 | CAPACITOR, CERAM | 12PF 2         | 500      | 4822 122 31196 |
| C 2725 | CAPACITOR, CERAM | 10NF-20+50     | 100      | 4822 122 31414 |
| C 2727 | CAPACITOR, CERAM | 1NF 10         | 100      | 4822 122 30027 |
| C 2728 | CAPACITOR, CERAM | 10NF-20+50     | 100      | 4822 122 31414 |
| C 2729 | CAPACITOR, CERAM | 270PF 2        | 100      | 4822 122 31335 |
| C 2730 | CAPACITOR, CERAM | 22PF 2         | 100      | 4822 122 31063 |
| C 2731 | CAPACITOR, CERAM | 10NF-20+50     | 100      | 4822 122 31414 |
| C 2732 | CAPACITOR, CERAM | 10NF-20+50     | 100      | 4822 122 31414 |
| C 2733 | CAP, ELECTROLYT. | 47UF-10+50     | 10       | 4822 124 20678 |
| C 2734 | CAPACITOR, FOIL  | 220NF 10%      | 100V     | 4822 121 40232 |
| C 2736 | CAP, ELECTROLYT. | 33UF-10+50     | 16       | 4822 124 20688 |
| C 2737 | CAPACITOR, FOIL  | 220NF 10%      | 100V     | 5322 121 40233 |
| C 2738 | CAPACITOR, CERAM | 100PF 2        | 100      | 4822 122 31316 |
| C 2739 | CAPACITOR, CERAM | 10NF-20+50     | 100      | 4822 122 31414 |
| C 2741 | CAP, ELECTROLYT. | 33UF-10+50     | 16       | 4822 124 20688 |
| C 2742 | CAPACITOR, CERAM | 10NF-20+50     | 100      | 4822 122 31414 |
| C 2743 | CAPACITOR, FOIL  | 680NF 10%      | 100V     | 5322 121 40233 |
| C 2744 | CAPACITOR, CERAM | 10NF-20+50     | 100      | 4822 122 31414 |
| C 2745 | CAPACITOR, CERAM | 2, 2PF 0, 25PF | 100      | 4822 122 31036 |
| C 2746 | CAPACITOR, CERAM | 100PF 2        | 100      | 4822 122 31316 |
| C 2747 | CAPACITOR, CERAM | 10NF-20+50     | 100      | 4822 122 31414 |
| C 2748 | CAPACITOR, CERAM | 10NF-20+50     | 100      | 4822 122 31414 |
| C 2749 | CAPACITOR, CERAM | 10NF-20+50     | 100      | 4822 122 31414 |
| C 2750 | CAPACITOR, CERAM | 10NF-20+50     | 100      | 4822 122 31414 |
| C 2751 | CAPACITOR, CERAM | 10NF-20+50     | 100      | 4822 122 31414 |
| C 2752 | CAPACITOR, CERAM | 10NF-20+50     | 100      | 4822 122 31414 |
| C 2753 | CAPACITOR, CERAM | 10NF-20+50     | 100      | 4822 122 31414 |
| C 2754 | CAPACITOR, CERAM | 10NF-20+50     | 100      | 4822 122 31414 |
| C 2756 | CAPACITOR, CERAM | 10NF-20+50     | 100      | 4822 122 31414 |
| C 2757 | CAPACITOR, CERAM | 10NF-20+50     | 100      | 4822 122 31414 |
| C 2901 | CAP, ELECTROLYT. | 68UF-10+50     | 16       | 4822 124 20689 |
| C 2902 | CAP, ELECTROLYT. | 47UF-10+50     | 10       | 4822 124 20678 |
| C 2903 | CAP, ELECTROLYT. | 47UF-10+50     | 10       | 4822 124 20678 |
| C 2904 | CAP, ELECTROLYT. | 10UF-10+50     | 63       | 4822 124 20728 |
| C 2905 | CAPACITOR, CERAM | 10NF-20+50     | 100      | 4822 122 31414 |
| C 2906 | CAP, ELECTROLYT. | 47UF-10+50     | 10       | 4822 124 20678 |
| C 2907 | CAP, ELECTROLYT. | 47UF-10+50     | 10       | 4822 124 20678 |
| C 2908 | CAP, ELECTROLYT. | 33UF-10+50     | 16       | 4822 124 20688 |
| C 2909 | CAP, ELECTROLYT. | 33UF-10+50     | 16       | 4822 124 20688 |
| C 2911 | CAPACITOR, CERAM | 10NF-20+50     | 100      | 4822 122 31414 |
| C 2912 | CAPACITOR, CERAM | 10NF-20+50     | 100      | 4822 122 31414 |
| C 2913 | CAPACITOR, CERAM | 12PF 2         | 100      | 4822 122 31056 |
| C 2914 | CAPACITOR, CERAM | 100PF 2        | 100      | 4822 122 31316 |
| C 2916 | CAPACITOR, CERAM | 12PF 2         | 100      | 4822 122 31056 |
| C 2917 | CAPACITOR, CERAM | 1NF 10         | 100      | 4822 122 30027 |
| C 2918 | CAPACITOR, CERAM | 220PF 2        | 100      | 4822 122 31222 |
| C 2919 | CAPACITOR, CERAM | 4, 7NF 10      | 100      | 4822 122 30128 |
| C 2920 | CAPACITOR, CERAM | 10NF-20+50     | 100      | 4822 122 31414 |
| C 2921 | CAPACITOR, CERAM | 5, 6PF 0, 25PF | 100      | 4822 122 31047 |
| C 2922 | CAPACITOR, CERAM | 10NF-20+50     | 100      | 4822 122 31414 |
| C 2923 | CAPACITOR, FOIL  |                | 5322 121 | 54228          |
| C 2924 | CAPACITOR, CERAM | 1NF 10         | 100      | 4822 122 30027 |
| C 2925 | CAPACITOR, CERAM | 4, 7NF 10      | 100      | 4822 122 30128 |
| C 2926 | CAPACITOR, CERAM | 10NF-20+50     | 100      | 4822 122 31414 |
| C 2927 | CAPACITOR, CERAM | 100PF 2        | 100      | 4822 122 31316 |
| C 2928 | CAPACITOR, CERAM | 10NF-20+50     | 100      | 4822 122 31414 |
| C 2929 | CAPACITOR, CERAM | 10NF-20+50     | 100      | 4822 122 31414 |
| C 2930 | CAPACITOR, CERAM | 1NF 10         | 100      | 4822 122 30027 |
| C 2931 | CAPACITOR, CERAM | 10NF-20+50     | 100      | 4822 122 31414 |

| POSHR  | DESCRIPTION       |              | ORDERING CODE |                |  |  |
|--------|-------------------|--------------|---------------|----------------|--|--|
| C 2932 | CAPACITOR, CERAM  | 1PF 0.25PF   | 100           | 4822 122 30104 |  |  |
| C 2933 | CAPACITOR, CERAM  | 1PF 0.25PF   | 100           | 4822 122 30104 |  |  |
| C 2934 | CAPACITOR, CERAM  | 10NF-20+50   | 100           | 4822 122 31414 |  |  |
| C 2935 | CAP, ELECTROLYT.  | 33UF 40%     | 10V           | 6822 124 20945 |  |  |
| C 2936 | CAPACITOR, CERAM  | 10NF-20+50   | 100           | 4822 122 31414 |  |  |
| C 2937 | CAPACITOR, CERAM  | 10NF-20+50   | 100           | 4822 122 31414 |  |  |
| C 2938 | CAPACITOR, CERAM  | 4.7PF 0.25PF | 100           | 4822 122 31045 |  |  |
| C 2939 | CAPACITOR, CERAM  | 4.7PF 0.25PF | 100           | 4822 122 31045 |  |  |
| C 2940 | CAPACITOR, CERAM  | 10NF-20+50   | 100           | 4822 122 31414 |  |  |
| C 2941 | CAPACITOR, CERAM  | 10NF-20+50   | 100           | 4822 122 31414 |  |  |
| C 2942 | CAPACITOR, CERAM  | 4.7PF 0.25PF | 100           | 4822 122 31045 |  |  |
| C 2943 | CAPACITOR, CERAM  | 10NF-20+50   | 100           | 4822 122 31414 |  |  |
| C 2944 | CAPACITOR, CERAM  | 10NF-20+50   | 100           | 4822 122 31414 |  |  |
| C 2945 | CAPACITOR, CERAM  | 180PF 10     | 100           | 4822 122 30113 |  |  |
| C 2946 | CAP, ELECTROLYT.  | 33UF-10+50   | 16            | 4822 124 20688 |  |  |
| C 2947 | CAPACITOR, FOIL   | 100NF 10%    | 100V          | 5322 121 40323 |  |  |
| C 2948 | CAPACITOR, CERAM  | 27PF 2       | 100           | 4822 122 30045 |  |  |
| C 2950 | CAPACITOR, CERAM  | 10NF-20+50   | 100           | 4822 122 31414 |  |  |
| C 3000 | CAPACITOR, CERAM  | 10NF-20+50   | 100           | 4822 122 31414 |  |  |
| C 3001 | CAPACITOR, CERAM  | 10NF-20+50   | 100           | 4822 122 31414 |  |  |
| C 3002 | CAPACITOR, CERAM  | 10NF-20+50   | 100           | 4822 122 31414 |  |  |
| C 3003 | CAPACITOR, CERAM  | 10NF-20+50   | 100           | 4822 122 31414 |  |  |
| C 3004 | CAPACITOR, CERAM  | 10NF-20+50   | 100           | 4822 122 31414 |  |  |
| C 3005 | CAPACITOR, CERAM  | 10NF-20+50   | 100           | 4822 122 31414 |  |  |
| C 3006 | CAPACITOR, CERAM  | 22PF 2       | 100           | 4822 122 31063 |  |  |
| C 3007 | CAPACITOR, CERAM  | 3.9PF 0.25PF | 100           | 5322 122 34107 |  |  |
| C 3008 | CAPACITOR, CERAM  | 3.9PF 0.25PF | 100           | 5322 122 34107 |  |  |
| C 3009 | CAPACITOR, FOIL   | 470NF 10%    | 100V          | 5322 121 40175 |  |  |
| C 3010 | CAP, ELECTROLYT.  | 47UF-10+50   | 10            | 4822 124 20678 |  |  |
| C 3011 | CAPACITOR, CERAM  | 47PF 2       | 100           | 4822 122 31072 |  |  |
| C 3012 | CAPACITOR, CERAM  | 10NF-20+50   | 100           | 4822 122 31414 |  |  |
| C 3013 | CAPACITOR, CERAM  | 10NF-20+50   | 100           | 4822 122 31414 |  |  |
| C 3014 | CAP, ELECTROLYT.  | 15UF 10%     | 16V           | 4822 124 20977 |  |  |
| C 3015 | CAP, ELECTROLYT.  | 3.3UF 40%    | 16V           | 4822 124 20947 |  |  |
| C 3016 | CAPACITOR, CERAM  | 15PF 2       | 100           | 4822 122 31058 |  |  |
| C 3017 | CAPACITOR, TRIMM  | 2.0-18P TRIM |               | 5322 125 50051 |  |  |
| C 3018 | CAPACITOR, CERAM  | 10NF-20+50   | 100           | 4822 122 31414 |  |  |
| C 3019 | CAPACITOR, CERAM  | 12PF 2       | 100           | 4822 122 31056 |  |  |
| C 3020 | CAP, ELECTROLYT.  | 3.3UF 40%    | 16V           | 4822 124 20947 |  |  |
| C 3021 | CAP, ELECTROLYT.  | 15UF 10%     | 16V           | 4822 124 20977 |  |  |
| C 3022 | CAP, ELEC. TANTAL | 6.8UF 20%    | 16V           | 5322 124 14069 |  |  |
| C 3023 | CAP, ELECTROLYT.  | 33UF-10+50   | 16            | 4822 124 20688 |  |  |
| C 3024 | CAPACITOR, CERAM  | 4.7NF 10     | 100           | 4822 122 30128 |  |  |
| C 3025 | CAPACITOR, CERAM  | 100PF 2      | 100           | 4822 122 31316 |  |  |
| C 3026 | CAPACITOR, CERAM  | 15PF 2       | 100           | 4822 122 31058 |  |  |
| C 3027 | CAPACITOR, CERAM  | 10NF-20+50   | 100           | 4822 122 31414 |  |  |
| C 3028 | CAPACITOR, CERAM  | 10PF 2       | 100           | 4822 122 31054 |  |  |
| C 3029 | CAPACITOR, CERAM  | 10PF 2       | 100           | 4822 122 31054 |  |  |
| C 3030 | CAPACITOR, CERAM  | 10NF-20+50   | 100           | 4822 122 31414 |  |  |
| C 3201 | CAPACITOR, CERAM  | 15PF 2       | 100           | 4822 122 31058 |  |  |
| C 3202 | CAPACITOR, CERAM  | 100NF 10%    | 50V           | 5322 122 30108 |  |  |
| C 3203 | CAPACITOR, CERAM  | 100NF 10%    | 50V           | 5322 122 30108 |  |  |
| C 3204 | CAPACITOR, CERAM  | 100NF 10%    | 50V           | 5322 122 30108 |  |  |
| C 3205 | CAPACITOR, CERAM  | 10NF-20+50   | 100           | 4822 122 31414 |  |  |
| C 3206 | CAPACITOR, CERAM  | 100NF 10%    | 50V           | 5322 122 30108 |  |  |
| C 3207 | CAPACITOR, CERAM  | 100NF 10%    | 50V           | 5322 122 30108 |  |  |
| C 3208 | CAPACITOR, FOIL   | 10NF 1%      | 63V           | 5322 121 54154 |  |  |
| C 3209 | CAPACITOR, FOIL   | 10NF 1%      | 63V           | 5322 121 54154 |  |  |
| C 3210 | CAPACITOR, FOIL   | 220PF 1%     | 630V          | 5322 121 54059 |  |  |
| C 3211 | CAPACITOR, CERAM  | 100NF 10%    | 50V           | 5322 122 30108 |  |  |
| C 3212 | CAPACITOR, CERAM  | 100NF 10%    | 50V           | 5322 122 30108 |  |  |
| C 3213 | CAPACITOR, CERAM  | 100NF 10%    | 50V           | 5322 122 30108 |  |  |
| C 3214 | CAPACITOR, CERAM  | 100NF 10%    | 50V           | 5322 122 30108 |  |  |
| C 3215 | CAPACITOR, CERAM  | 10NF-20+50   | 100           | 4822 122 31414 |  |  |
| C 3216 | CAPACITOR, CERAM  | 15PF 2       | 100           | 4822 122 31058 |  |  |

| POSHR  | DESCRIPTION       |                 | ORDERING CODE |                |  |  |
|--------|-------------------|-----------------|---------------|----------------|--|--|
| C 3217 | CAP, ELEC. TANTAL | 6.8UF 20%       | 25V           | 5322 124 14081 |  |  |
| C 3218 | CAP, ELEC. TANTAL | 6.8UF 20%       | 25V           | 5322 124 14081 |  |  |
| C 3219 | CAPACITOR, CERAM  | 15PF 2          | 100           | 4822 122 31058 |  |  |
| C 3220 | CAPACITOR, CERAM  | 10NF-20+50      | 100           | 4822 122 31414 |  |  |
| C 3221 | CAPACITOR, CERAM  | 10NF-20+50      | 100           | 4822 122 31414 |  |  |
| C 3222 | CAPACITOR, FOIL   | 100NF 10%       | 630V          | 5322 121 54059 |  |  |
| C 3223 | CAPACITOR, CERAM  | 100NF 10%       | 100           | 4822 122 31414 |  |  |
| C 3224 | CAPACITOR, CERAM  | 100NF 10%       | 50V           | 5322 122 30108 |  |  |
| C 3225 | CAPACITOR, CERAM  | 10NF-20+50      | 100           | 4822 122 31414 |  |  |
| C 3226 | CAPACITOR, CERAM  | 100NF 10%       | 50V           | 5322 122 30108 |  |  |
| C 3227 | CAPACITOR, CERAM  | 100NF 10%       | 50V           | 5322 122 30108 |  |  |
| C 3228 | CAPACITOR, CERAM  | 100NF 10%       | 50V           | 5322 122 30108 |  |  |
| C 3229 | CAPACITOR, CERAM  | 33UF 40%        | 10V           | 4822 124 20945 |  |  |
| C 3230 | CAPACITOR, CERAM  | 10NF-20+50      | 100           | 4822 122 31414 |  |  |
| C 3231 | CAP, ELEC. TANTAL | 25V             | 25V           | 5322 124 14081 |  |  |
| C 3232 | CAP, ELEC. TANTAL | 6.8UF 20%       | 25V           | 5322 124 14081 |  |  |
| C 3233 | CAPACITOR, CERAM  | 10NF-20+50      | 100           | 4822 122 31414 |  |  |
| C 3234 | CAPACITOR, CERAM  | 10NF-20+50      | 100           | 4822 122 31414 |  |  |
| C 3235 | CAPACITOR, CERAM  | 10NF-20+50      | 100           | 4822 122 31414 |  |  |
| C 3236 | CAP, ELECTROLYT.  | 15UF-10+50      | 40            | 4822 124 20709 |  |  |
| C 3237 | CAP, ELECTROLYT.  | 100UF-10+50     | 40            | 4822 124 20715 |  |  |
| C 3239 | CAPACITOR, CERAM  | 10NF-20+50      | 100           | 4822 122 31414 |  |  |
| C 3401 | CAPACITOR, CERAM  | 5.6PF 0.25PF    | 100           | 4822 122 31047 |  |  |
| C 3402 | CAPACITOR, CERAM  | 100NF 10%       | 50V           | 5322 122 30108 |  |  |
| C 3403 | CAPACITOR, CERAM  | 100NF 10%       | 50V           | 5322 122 30108 |  |  |
| C 3404 | CAP, ELECTROLYT.  | 33UF 40%        | 10V           | 4822 124 20945 |  |  |
| C 3406 | CAPACITOR, CERAM  | 100NF 10%       | 50V           | 5322 122 30108 |  |  |
| C 3407 | CAPACITOR, CERAM  | 5.6PF 0.25PF    | 100           | 4822 122 31047 |  |  |
| C 3408 | CAPACITOR, CERAM  | 100NF 10%       | 50V           | 5322 122 30108 |  |  |
| C-3409 |                   |                 |               |                |  |  |
| C 3411 | CAPACITOR, CERAM  | 100NF 10%       | 50V           | 5322 122 30108 |  |  |
| C 3412 | CAPACITOR, CERAM  | 100NF 10%       | 50V           | 5322 122 30108 |  |  |
| C 3413 | CAPACITOR, CERAM  | 100NF 10%       | 50V           | 5322 122 30108 |  |  |
| C 3414 | CAPACITOR, CERAM  | 100NF 10%       | 50V           | 5322 122 30108 |  |  |
| C 3416 |                   | 6.8UF 20%       | 25V           | 5322 124 14081 |  |  |
| C 3417 | CAPACITOR, CERAM  | 100NF 10%       | 50V           | 5322 122 30108 |  |  |
| C 3418 | CAPACITOR, CERAM  | 100PF 2         | 100           | 4822 122 31504 |  |  |
| C 3419 | CAPACITOR, CERAM  | 10NF-20+50      | 100           | 4822 122 31414 |  |  |
| C 3422 | CAP, ELEC. TANTAL | 6.8UF 20%       | 25V           | 5322 124 14081 |  |  |
| C 3423 | CAPACITOR, CERAM  | 100NF 10%       | 50V           | 5322 122 30108 |  |  |
| D 1101 | INTEGR. CIRCUIT   | LF356N          | SC            | 5322 209 86422 |  |  |
| D 1103 | INTEGR. CIRCUIT   | LM78L15ACZ      | NS            | 4822 209 80889 |  |  |
| D 1104 | INTEGR. CIRCUIT   | LF356N          | SC            | 5322 209 86422 |  |  |
| D 1201 | INTEGR. CIRCUIT   | HEF4526BP       | PH            | 5322 209 14858 |  |  |
| D 1202 | INTEGR. CIRCUIT   | HEF4526BP       | PH            | 5322 209 14858 |  |  |
| D 1203 | INTEGR. CIRCUIT   | HEF4518BP       | PH            | 5322 209 14064 |  |  |
| D 1204 | INTEGR. CIRCUIT   | HEF4518BP       | PH            | 5322 209 14064 |  |  |
| O 1206 | INTEGR. CIRCUIT   | HEF4518BP       | PH            | 5322 209 14064 |  |  |
| D 1207 | INTEGR. CIRCUIT   | HEF4520BP       | PH            | 5322 209 14189 |  |  |
| D 1208 | INTEGR. CIRCUIT   | N74LS90N        | SC            | 5322 209 85255 |  |  |
| D 1209 | INTEGR. CIRCUIT   | DM74S196N       | NS            | 5322 209 81328 |  |  |
| D 1211 | INTEGR. CIRCUIT   | HEF4013BP       | PH            | 5322 209 10002 |  |  |
| O 1212 | INTEGR. CIRCUIT   | UA741CN         | SC            | 4822 209 80617 |  |  |
| D 1213 | INTEGR. CIRCUIT   | 11C58PC         | FA            | 5322 209 86446 |  |  |
| D 1214 | INTEGR. CIRCUIT   | HEF4051BP       | PH            | 5322 209 14212 |  |  |
| O 1216 | INTEGR. CIRCUIT   | N74LS139N       | SC            | 5322 209 85839 |  |  |
| O 1217 | INTEGR. CIRCUIT   | N74LS02N        | SC            | 5322 209 85312 |  |  |
| O 1218 | INTEGR. CIRCUIT   | N74LS00N        | SC            | 5322 209 84823 |  |  |
| O 1219 | INTEGR. CIRCUIT   | N74LS153N       | SC            | 5322 209 85488 |  |  |
| D 1221 | INTEGR. CIRCUIT   | SN74LS373N-00 T | SC            | 5322 209 86062 |  |  |
| O 1222 | INTEGR. CIRCUIT   | N74LS74AN       | SC            | 4822 209 80782 |  |  |
| D 1223 | INTEGR. CIRCUIT   | N74LS153N       | SC            | 5322 209 85688 |  |  |
| O 1224 | INTEGR. CIRCUIT   | GXB10174P       | PH            | 5322 209 86442 |  |  |
| D 1226 | INTEGR. CIRCUIT   | GXB10124P       | PH            | 5322 209 86341 |  |  |
| D 1227 | INTEGR. CIRCUIT   | GXB10231P       | PH            | 5322 209 86003 |  |  |

| POSNR  | DESCRIPTION     | ...           | ORDERING CODE     |
|--------|-----------------|---------------|-------------------|
| D 1228 | INTEGR. CIRCUIT | 74LS32        | MN 5322 209 85311 |
| D 1229 | INTEGR. CIRCUIT | N7404N        | SC 5322 209 86326 |
| D 1231 | INTEGR. CIRCUIT | GXB10125P     | PH 5322 209 86499 |
| D 1301 | INTEGR. CIRCUIT | N74LS191N     | SC 5322 209 84989 |
| D 1302 | INTEGR. CIRCUIT | N74LS191N     | SC 5322 209 84989 |
| D 1303 | INTEGR. CIRCUIT | GX810124P     | PH 5322 209 86341 |
| D 1304 | INTEGR. CIRCUIT | GX810231P     | PH 5322 209 86003 |
| D 1306 | INTEGR. CIRCUIT | GXB10137P     | PH 5322 209 81206 |
| D 1307 | INTEGR. CIRCUIT | GXB10125P     | PH 5322 209 86499 |
| D 1308 | INTEGR. CIRCUIT | SN74197N-00   | T 5322 209 84516  |
| D 1309 | INTEGR. CIRCUIT | N74LS193N     | SC 5322 209 85405 |
| D 1311 | INTEGR. CIRCUIT | N74LS193N     | SC 5322 209 85405 |
| D 1312 | INTEGR. CIRCUIT | N74LS193N     | SC 5322 209 85405 |
| D 1313 | INTEGR. CIRCUIT | N74LS08N      | SC 5322 209 84995 |
| D 1314 | INTEGR. CIRCUIT | N74LS74AN     | SC 4822 209 80782 |
| D 1316 | INTEGR. CIRCUIT | N74LS08N      | SC 5322 209 84995 |
| D 1317 | INTEGR. CIRCUIT | N74LS74AN     | SC 4822 209 80782 |
| D 1318 | INTEGR. CIRCUIT | N74LS00N      | SC 5322 209 84823 |
| D 1319 | INTEGR. CIRCUIT | UA741CN       | SC 4822 209 80617 |
| D 1321 | INTEGR. CIRCUIT | SN74LS123N-00 | T 5322 209 85266  |
| D 1322 | INTEGR. CIRCUIT | N74LS107N     | SC 5322 209 85816 |
| D 1323 | INTEGR. CIRCUIT | N74LS10N      | SC 5322 209 84996 |
| D 1324 | INTEGR. CIRCUIT | SN74LS27N-00  | T 5322 209 86076  |
| D 1326 | INTEGR. CIRCUIT | SN74LS373N-00 | T 5322 209 86062  |
| D 1327 | INTEGR. CIRCUIT | NE5018N       | SC 5322 209 86421 |
| D 1328 | INTEGR. CIRCUIT | NE5537H       | SC 5322 209 86444 |
| D 1329 | INTEGR. CIRCUIT | NE5537H       | SC 5322 209 86444 |
| D 1331 | INTEGR. CIRCUIT | UA741CN       | SC 4822 209 80617 |
| D 1501 | INTEGR. CIRCUIT | UA7905UC      | FA 5322 130 44843 |
| D 1502 | INTEGR. CIRCUIT | UA741CN       | SC 4822 209 80617 |
| D 1503 | INTEGR. CIRCUIT | UA741CN       | SC 4822 209 80617 |
| D 1601 | INTEGR. CIRCUIT | TD10160       | PH 5322 209 85662 |
| D 1602 | SENSOR          | H11A550       | GE 5322 130 94015 |
| D 2001 | INTEGR. CIRCUIT | LF356N        | NS 5322 209 66451 |
| D 2002 | INTEGR. CIRCUIT | LM358N        | PH 4822 209 81472 |
| D 2003 | INTEGR. CIRCUIT | LF356N        | NS 5322 209 86451 |
| D 2004 | INTEGR. CIRCUIT | TL082CP       | T 5322 209 86064  |
| D 2006 | INTEGR. CIRCUIT | HEF40528P     | PH 5322 209 14233 |
| D 2007 | INTEGR. CIRCUIT | LF356N        | NS 5322 209 86451 |
| D 2008 | INTEGR. CIRCUIT | HEF40538P     | PH 5322 209 14121 |
| D 2009 | INTEGR. CIRCUIT | TL082CP       | T 5322 209 86064  |
| D 201  | INTEGR. CIRCUIT | SN74LS373N-00 | T 5322 209 86062  |
| D 2011 | INTEGR. CIRCUIT | HEF40528P     | PH 5322 209 14233 |
| D 2012 | INTEGR. CIRCUIT | HEF40528P     | PH 5322 209 14233 |
| D 2013 | INTEGR. CIRCUIT | HEF40528P     | PH 5322 209 14233 |
| D 2014 | INTEGR. CIRCUIT | TL082CP       | T 5322 209 86064  |
| D 2016 | INTEGR. CIRCUIT | TL082CP       | T 5322 209 86064  |
| D 2017 | INTEGR. CIRCUIT | HEF40528P     | PH 5322 209 14233 |
| D 2018 | INTEGR. CIRCUIT | HEF40528P     | PH 5322 209 14233 |
| D 2019 | INTEGR. CIRCUIT | NE5537H       | SC 5322 209 86444 |
| D 202  | INTEGR. CIRCUIT | SN74LS373N-00 | T 5322 209 86062  |
| D 2021 | INTEGR. CIRCUIT | LF356N        | NS 5322 209 86451 |
| D 2022 | INTEGR. CIRCUIT | N74LS00N      | SC 5322 209 84823 |
| D 2023 | INTEGR. CIRCUIT | 00-0017       | SC 5322 209 85627 |
| D 2024 | INTEGR. CIRCUIT | NE5537H       | SC 5322 209 86444 |
| D 2026 | INTEGR. CIRCUIT | NE5537H       | SC 5322 209 86444 |
| D 203  | INTEGR. CIRCUIT | N74LS138N     | SC 5322 209 85647 |
| D 204  | INTEGR. CIRCUIT | TDA3081       | PH 5322 209 85767 |
| D 206  | INTEGR. CIRCUIT | N74LS00N      | SC 5322 209 84823 |
| D 2401 | INTEGR. CIRCUIT | SD5000N       | SC 5322 209 85748 |
| D 2402 | INTEGR. CIRCUIT | N7406N        | SC 5322 209 86327 |
| D 2403 | INTEGR. CIRCUIT | SD5000N       | SC 5322 209 85748 |
| D 2404 | INTEGR. CIRCUIT | 09 0012       | SC 5322 209 85484 |
| D 2406 | INTEGR. CIRCUIT | 00 0043       | SC 5322 209 86488 |
| D 2407 | INTEGR. CIRCUIT | LM308AN       | NS 5322 209 86056 |

| POSNR  | DESCRIPTION      | ...            | ORDERING CODE     |
|--------|------------------|----------------|-------------------|
| D 2408 | INTEGR. CIRCUIT  | LM308AN        | NS 5322 209 86056 |
| D 2409 | INTEGR. CIRCUIT  | 00 0012        | SC 5322 209 85484 |
| D 241  | INTEGR. CIRCUIT  | SN74LS257N-00  | SC 5322 209 80859 |
| D 2411 | INTEGR. CIRCUIT  | SD5000N        | SC 5322 209 85748 |
| D 2412 | INTEGR. CIRCUIT  | 09 0012        | SC 5322 209 85484 |
| D 2413 | INTEGR. CIRCUIT  | 00 0043        | NS 5322 209 86488 |
| D 2414 | INTEGR. CIRCUIT  | LM308AN        | NS 5322 209 86056 |
| D 2416 | INTEGR. CIRCUIT  | LM308AN        | NS 5322 209 86056 |
| D 2417 | INTEGR. CIRCUIT  | LM339AN        | SC 4822 209 80631 |
| D 2418 | INTEGR. CIRCUIT  | SN74LS257N-00  | T 5322 209 80859  |
| D 2419 | INTEGR. CIRCUIT  | SN74LS257N-00  | T 5322 209 80859  |
| D 242  | INTEGR. CIRCUIT  | SN74LS257N-00  | T 5322 209 80859  |
| D 2421 | INTEGR. CIRCUIT  | LM324N         | SC 4822 209 80587 |
| D 2422 | INTEGR. CIRCUIT  | LM324N         | SC 4822 209 80587 |
| D 2423 | INTEGR. CIRCUIT  | N74LS32N       | SC 5322 209 85311 |
| D 2424 | INTEGR. CIRCUIT  | SN74LS373N-00  | T 5322 209 86062  |
| D 2426 | INTEGR. CIRCUIT  | SN74LS373N-00  | T 5322 209 86062  |
| D 2427 | INTEGR. CIRCUIT  | SN74LS373N-00  | T 5322 209 86062  |
| D 2428 | INTEGR. CIRCUIT  | N74LS00N       | SC 5322 209 84823 |
| D 2423 | INTEGR. CIRCUIT  | N74LS00N       | SC 5322 209 84823 |
| D 243  | INTEGR. CIRCUIT  | SN74LS257N-00  | T 5322 209 80859  |
| D 2431 | INTEGR. CIRCUIT  | N74LS139N      | SC 5322 209 85839 |
| D 2432 | INTEGR. CIRCUIT  | SN74LS27N-00   | T 5322 209 86076  |
| D 244  | INTEGR. CIRCUIT  | N74LS08N       | SC 5322 209 84995 |
| D 246  | INTEGR. CIRCUIT  | N74LS138N      | SC 5322 209 85647 |
| D 247  | INTEGR. CIRCUIT  | SN74LS257N     | T 5322 209 80859  |
| D 248  | INTEGR. CIRCUIT  | SN74LS257N     | T 5322 209 80859  |
| D 249  | INTEGR. CIRCUIT  | SN74LS257N     | T 5322 209 80859  |
| D 2701 | INTEGR. CIRCUIT  | HEF4052BP      | H 5322 209 14233  |
| D 2702 | INTEGR. CIRCUIT  | SN74LS123N     | T 5322 209 85266  |
| D 2703 | INTEGR. CIRCUIT  | CA3086         | PH 4822 209 86238 |
| D 2704 | INTEGR. CIRCUIT  | LM358N         | PH 5322 209 86056 |
| D 2706 | INTEGR. CIRCUIT  | LM308AN        | NS 4822 209 80782 |
| D 2707 | INTEGR. CIRCUIT  | N74LS74AN      | SC 5322 209 86451 |
| D 2708 | INTEGR. CIRCUIT  | LF356N         | NS 5322 209 86451 |
| D 2709 | INTEGR. CIRCUIT  | LF4052         | PH 5322 209 14233 |
| D 2711 | INTEGR. CIRCUIT  | 00 01          | SC 5322 209 85484 |
| D 2901 | INTEGR. CIRCUIT  | TL082CF        | T 5322 209 86064  |
| D 2902 | INTEGR. CIRCUIT  | NE521N         | SC 5322 209 86064 |
| D 2903 | INTEGR. CIRCUIT  | N74LS1         | SC 5322 209 85201 |
| 3 2904 | INTEGR. CIRCUIT  | GXB10231P      | H 5322 209 86003  |
| D 2906 | INTEGR. CIRCUIT  | GXB10125P      | H 5322 209 86499  |
| D 2907 | INTEGR. CIRCUIT  | GXB10116P      | H 5322 209 86441  |
| D 2908 | INTEGR. CIRCUIT  | SN74LS151M     | T 5322 209 86452  |
| D 2909 | INTEGR. CIRCUIT  | SN74LS174N-0   | T 5322 209 84183  |
| D 2911 | INTEGR. CIRCUIT  | N74LS04N       | SC 4822 209 80783 |
| D 2912 | INTEGR. CIRCUIT  | N74LS00N       | SC 5322 209 84167 |
| D 2913 | INTEGR. CIRCUIT  | LM308AN        | NS 5322 209 86056 |
| D 3001 | INTEGR. CIRCUIT  | EN H GATE      | 5c 5322 209 86491 |
| D 3002 | INTEGR. CIRCUIT  | UA741CN        | 5c 4822 209 80617 |
| D 3003 | INTEGR. CIRCUIT  | TL082CP        | T 5322 209 86064  |
| D 3004 | INTEGR. CIRCUIT  | ARRAY 09-0145  | T 5322 209 81324  |
| D 3006 | INTEGR. CIRCUIT  | TL082CP        | T 5322 209 86064  |
| D 3101 | UNIT, ELECTRICAL | BG2000-641/001 | 5322 218 61001    |
| D 3201 | INTEGR. CIRCUIT  | LM358N         | PH 4822 209 81472 |
| D 3202 | INTEGR. CIRCUIT  | HEF4052BP      | PH 5322 209 14233 |
| D 3203 | INTEGR. CIRCUIT  | LM358N         | PH 4822 209 81472 |
| D 3204 | INTEGR. CIRCUIT  | LF356N         | SC 5322 239 86422 |
| D 3206 | INTEGR. CIRCUIT  | HEF40518P      | PH 5322 209 84958 |
| D 3208 | INTEGR. CIRCUIT  | GXB10102P      | PH 5322 209 86003 |
| D 3209 | INTEGR. CIRCUIT  | GXB10231P      | PH 5322 209 86003 |
| D 3211 | INTEGR. CIRCUIT  | GXB10102P      | PH 5322 209 85955 |
| D 3212 | INTEGR. CIRCUIT  | LF356N         | SC 5322 209 86422 |
| D 3213 | INTEGR. CIRCUIT  | LF356N         | SC 5322 209 86422 |
| D 3214 | INTEGR. CIRCUIT  | GXB10125P      | PH 5322 209 86499 |

| POSNR  | DESCRIPTION                    | ORDERING CODE  |
|--------|--------------------------------|----------------|
| D 3216 | INTEGR.CIRCUIT GXB10231P PH    | 5322 209 86003 |
| D 3217 | INTEGR.CIRCUIT GXB10231P PH    | 5322 209 86003 |
| D 3218 | INTEGR.CIRCUIT GXB10124P PH    | 5322 209 86341 |
| D 3219 | INTEGR.CIRCUIT LF356N SC       | 5322 209 86422 |
| D 3221 | INTEGR.CIRCUIT HEF40528P PH    | 5322 209 14233 |
| D 3222 | INTEGR.CIRCUIT HEF40528P PH    | 5322 209 14233 |
| D 3223 | INTEGR.CIRCUIT LM358N PH       | 4822 209 81472 |
| D 3224 | INTEGR.CIRCUIT LM78L05ACZ NS   | 5322 209 80903 |
| D 401  | INTEGR.CIRCUIT MCM51L01P45 MO  | 5322 209 10155 |
| D 402  | INTEGR.CIRCUIT MCM51L01P45 MO  | 5322 209 10155 |
| D 403  | I.C. ROM                       | 5322 209 10369 |
| D 404  | I.C. ROM                       | 5322 209 10371 |
| D 406  | I.C. ROM                       | 5322 209 10372 |
| D 408  | INTEGR.CIRCUIT P3085-AH IT     | 5322 209 50032 |
| D 409  | INTEGR.CIRCUIT N74LS74AN SC    | 4822 209 80782 |
| D 411  | INTEGR.CIRCUIT N74LS30N SC     | 5322 209 84985 |
| D 412  | INTEGR.CIRCUIT N74LS30N SC     | 5322 209 84985 |
| D 413  | INTEGR.CIRCUIT SN74LS373N-00 T | 5322 209 86062 |
| D 414  | INTEGR.CIRCUIT SN74LS373N-00 T | 5322 209 86062 |
| D 416  | INTEGR.CIRCUIT SN74LS373N-00 T | 5322 209 86062 |
| D 417  | INTEGR.CIRCUIT SN74LS245N-00 i | 5322 209 86225 |
| D 418  | INTEGR.CIRCUIT N74LS138N SC    | 5322 209 85647 |
| D 419  | INTEGR.CIRCUIT N74LS139N SC    | 5322 209 85839 |
| D 421  | INTEGR.CIRCUIT N74LS32N SC     | 5322 209 85311 |
| D 422  | INTEGR.CIRCUIT N74LS04N SC     | 4822 209 80783 |
| D 423  | INTEGR.CIRCUIT N74LS74AN SC    | 4822 209 80782 |
| D 424  | INTEGR.CIRCUIT HEF45288P PH    | 4822 209 10277 |
| O 426  | INTEGR.CIRCUIT HEF40938P PH    | 5322 209 14186 |
| D 428  | INTEGR.CIRCUIT N74LS04N SC     | 4822 209 80783 |
| D 429  | INTEGR.CIRCUIT N74LS74AN SC    | 4822 209 80782 |
| D 601  | INTEGR.CIRCUIT MCM51L01P45 MO  | 5322 209 10155 |
| D 602  | INTEGR.CIRCUIT MCM51L01P45 MO  | 5322 209 10155 |
| D 603  | INTEGR.CIRCUIT MCM51L01P45 MO  | 5322 209 10155 |
| D 604  | INTEGR.CIRCUIT MCM51L01P45 MO  | 5322 209 10155 |
| O 606  | INTEGR.CIRCUIT MCM51L01P45 MO  | 5322 209 10155 |
| D 607  | INTEGR.CIRCUIT MCM51L01P45 MO  | 5322 209 10155 |
| D 608  | INTEGR.CIRCUIT MCM51L01P45 MO  | 5322 209 10155 |
| D 609  | INTEGR.CIRCUIT MCM51L01P45 MO  | 5322 209 10155 |
| D 611  | INTEGR.CIRCUIT SN74LS257N-00   | 5322 209 80859 |
| D 612  | INTEGR.CIRCUIT SN74LS257N-00 T | 5322 209 80859 |
| D 613  | INTEGR.CIRCUIT SN74LS373N-00 T | 5322 209 86062 |
| D 614  | INTEGR.CIRCUIT SN74LS244N-00 T | 5322 209 86017 |
| D 616  | INTEGR.CIRCUIT SN74LS244N-00 T | 5322 209 86017 |
| D 617  | INTEGR.CIRCUIT SN74LS244N-00 T | 5322 209 86017 |
| D 618  | INTEGR.CIRCUIT N74LS266N SC    | 5322 209 86163 |
| D 619  | INTEGR.CIRCUIT N74LS266N SC    | 5322 209 86163 |
| O 621  | INTEGR.CIRCUIT NE5018N SC      | 5322 209 86421 |
| D 622  | INTEGR.CIRCUIT NE5018N SC      | 5322 209 86421 |
| D 623  | INTEGR.CIRCUIT N74LS86N SC     | 5322 209 84997 |
| D 624  | INTEGR.CIRCUIT N74LS86N SC     | 5322 209 84997 |
| D 626  | INTEGR.CIRCUIT N74LS04N SC     | 4822 209 80783 |
| D 627  | INTEGR.CIRCUIT N74LS00N SC     | 5322 209 84823 |
| D 628  | INTEGR.CIRCUIT N74LS153N SC    | 5322 209 85488 |
| D 629  | INTEGR.CIRCUIT N74LS02N SC     | 5322 209 85312 |
| D 701  | INTEGR.CIRCUIT HEF4731VP PH    | 5322 209 14859 |
| D 702  | INTEGR.CIRCUIT HEF4731VP PH    | 5322 209 14859 |
| D 703  | INTEGR.CIRCUIT HEF4731VP PH    | 5322 209 14859 |
| D 704  | INTEGR.CIRCUIT HEF4731VP PH    | 5322 209 14859 |
| D 706  | INTEGR.CIRCUIT HEF4731VP PH    | 5322 209 14859 |
| D 707  | INTEGR.CIRCUIT HEF4731VP PH    | 5322 209 14859 |
| D 708  | INTEGR HEF4731VP PH            | 5322 209 14859 |
| O 709  | INTEGR HEF4731VP PH            | 5322 209 14859 |
| D 711  | INTEGR.CIRCUIT HEF4731VP PH    | 5322 209 14859 |
| O 712  | INTEGR.CIRCUIT HEF45088P PH    | 5322 209 14559 |
| D 713  | INTEGR.CIRCUIT HEF45088P PH    | 5322 209 14559 |

| POSNR  | DESCRIPTION                   | ORDERING CODE                       |
|--------|-------------------------------|-------------------------------------|
| D 714  | INTEGR.CIRCUIT HE5018N SC     | 5322 209 86421                      |
| D 716  | INTEGR.CIRCUIT HEF40097BP PH  | 5322 209 14433                      |
| D 717  | INTEGR.CIRCUIT HEF40097BP PH  | 5322 209 14433                      |
| D 718  | INTEGR.CIRCUIT HEF40018P PH   | 5322 209 14045                      |
| D 719  | INTEGR.CIRCUIT HEF40498P PH   | 5322 209 14049                      |
| D 801  | INTEGR.CIRCUIT HEF4081BP PH   | 5322 209 14054                      |
| D 802  | INTEGR.CIRCUIT HEF4070BP PH   | 4822 209 10265                      |
| D 803  | INTEGR.CIRCUIT HEF4008BP PH   | 5322 209 14214                      |
| D 804  | INTEGR.CIRCUIT HEF4008BP PH   | 5322 209 14214                      |
| D 806  | INTEGR.CIRCUIT HEF4539BP PH   | 5322 209 14442                      |
| D 807  | INTEGR.CIRCUIT HEF4539BP PH   | 5322 209 14442                      |
| D 808  | INTEGR.CIRCUIT HEF4073BP PH   | 4822 209 10266                      |
| D 809  | INTEGR.CIRCUIT HEF4070BP PH   | 5322 209 14433                      |
| O 811  | INTEGR.CIRCUIT HEF40097BP PH  | 5322 209 14433                      |
| D 812  | INTEGR.CIRCUIT HEF40097BP PH  | 5322 209 14433                      |
| D 813  | INTEGR.CIRCUIT HEF4081BP PH   | 5322 209 14054                      |
| D 814  | INTEGR.CIRCUIT HEF4070BP PH   | 4822 209 10265                      |
| D 816  | INTEGR.CIRCUIT HEF4008BP PH   | 5322 209 14214                      |
| D 817  | INTEGR.CIRCUIT HEF4539BP PH   | 5322 209 14442                      |
| D 818  | INTEGR.CIRCUIT HEF4539BP PH   | 5322 209 14442                      |
| D 819  | INTEGR.CIRCUIT HEF4508BP PH   | 5322 209 14559                      |
| D 821  | INTEGR.CIRCUIT A0C80-AGZ-1 BB | 5322 209 86444                      |
| D 822  | INTEGR.CIRCUIT NE5537H SC     | 5322 209 85488                      |
| D 901  | INTEGR.CIRCUIT N74LS153N SC   | 4822 209 80782                      |
| D 902  | INTEGR.CIRCUIT N74LS74AN SC   | 5322 209 84823                      |
| 3 903  | INTEGR.CIRCUIT N74LS00N SC    | 5322 209 86421                      |
| D 904  | INTEGR.CIRCUIT NE5018N SC     | 5322 209 84995                      |
| D 906  | INTEGR.CIRCUIT N74LS08N SC    | 4822 209 80782                      |
| D 907  | INTEGR.CIRCUIT N74LS74AN SC   | 4822 209 80782                      |
| D 908  | INTEGR.CIRCUIT N74LS74AN SC   | 4822 209 80782                      |
| D 909  | INTEGR.CIRCUIT N74LS74AN SC   | 4822 209 80782                      |
| D 911  | INTEGR.CIRCUIT N74LS153N SC   | 5322 209 85488                      |
| D 912  | INTEGR.CIRCUIT N74LS11N SC    | 5322 209 85604                      |
| D 913  | INTEGR.CIRCUIT N74LS74AN SC   | 4822 209 80782                      |
| D 914  | INTEGR.CIRCUIT N74LS00N SC    | 5322 209 84167                      |
| D 916  | INTEGR.CIRCUIT N74LS153N SC   | 5322 209 85488                      |
| D 917  | INTEGR.CIRCUIT N74LS163AN SC  | 5322 209 85863                      |
| D 918  | INTEGR.CIRCUIT N74LS163AN SC  | 3322 209 85863                      |
| D 919  | INTEGR.CIRCUIT N74LS04N SC    | 4822 209 80782                      |
| D 921  | INTEGR.CIRCUIT N74LS153N SC   | 4822 209 80782                      |
| D 922  | INTEGR.CIRCUIT N74LS00N SC    | 4822 209 80935                      |
| 3 923  | INTEGR.CIRCUIT N74LS42N SC    | 4822 209 80782                      |
| D 924  | INTEGR.CIRCUIT N74LS74AN SC   | 5322 209 85488                      |
| D 926  | INTEGR.CIRCUIT N74LS153N SC   | 4822 209 80782                      |
| O 927  | INTEGR.CIRCUIT N74LS74AN SC   | 4822 209 80782                      |
| D 928  | INTEGR.CIRCUIT N74LS163AN SC  | 5322 209 85863                      |
| E 1    | LAMP,FILAMENT                 | 5322 134 44177                      |
| E 2    | LAMP,FILAMENT                 | 5322 134 44177                      |
| F 1701 | FUSE                          | 4822 253 30025                      |
| G 1    | BATTERY                       | T2A BATTERY 1.5V R6P 5322 138 10071 |
| G 2    | BATTERY                       | BATTERY 1.5V R6P 5322 138 10071     |
| K 2401 | RELAY                         | 5322 280 24126                      |
| K 2402 | RELAY                         | 5322 280 24126                      |
| K 2403 | RELAY                         | 5322 280 24126                      |
| K 2404 | RELAY                         | 5322 280 24126                      |
| K 2406 | RELAY                         | 5322 280 24126                      |
| K 2407 | RELAY                         | 5322 280 24126                      |
| K 2408 | RELAY                         | 5322 280 24126                      |
| K 2409 | RELAY                         | 5322 280 24126                      |
| K 2411 | RELAY                         | 5322 280 24126                      |



| POSNR  | DESCRIPTION       | ORDERING CODE                    |
|--------|-------------------|----------------------------------|
| K 2412 | RELAY             | 5322 280 24126                   |
| K 2413 | RELAY             | 5322 280 24126                   |
| K 2414 | RELAY             | 5322 280 24126                   |
| K 2416 | RELAY             | 5322 280 24126                   |
| K 2418 | RELAY             | 5322 280 24126                   |
| K 2701 | RELAY, REED       | SAM. REED-RELAIS 5322 280 24131  |
| L 1101 | COIL              | SPOEL 5322 156 14101             |
| L 1102 | COIL              | SPOEL 5322 156 14101             |
| L 1104 | COIL              | SPOEL 5322 156 14101             |
| L 1106 | COIL              | SPOEL 5322 156 14101             |
| L 1501 | COIL, CHOKE       | 4822 152 20486                   |
| L 1502 | COIL, CHOKE       | 4822 152 20486                   |
| L 1503 | COIL, CHOKE       | 4822 152 20486                   |
| L 1504 | COIL, CHOKE       | 4822 152 20486                   |
| L 1506 | COIL, CHOKE       | 5322 152 24095                   |
| L 1508 | COIL, CHOKE       | 5322 152 24094                   |
| L 1509 | COIL, CHOKE       | 5322 152 24094                   |
| L 1601 | COIL              | COIL SMOORSPOEL 5322 281 64154   |
| L 1602 | COIL, CHOKE       | SPOEL 5322 152 24062             |
| L 1603 | COIL              | SPOEL 5322 156 14076             |
| L 1604 | COIL              | SPOEL 5322 156 14076             |
| L 2401 | COIL              | SPOEL 5322 156 14076             |
| L 2402 | COIL              | SPOEL 5322 156 14076             |
| L 2403 | COIL              | SPOEL 5322 156 14076             |
| L 2404 | COIL              | SPOEL 5322 156 14076             |
| L 2406 | COIL              | 5322 158 14283                   |
| L 2407 | COIL              | 5322 158 14283                   |
| L 2408 | COIL              | 5322 158 14283                   |
| L 2409 | COIL              | 5322 158 14283                   |
| L 2411 | COIL              | 5322 158 14283                   |
| L 2412 | COIL              | 5322 158 14283                   |
| L 3201 | COIL              | MICRO CHOKE 1.5MH 5322 158 14229 |
| R 1    | POTM, CARBON      | 47K 20 0.1W 5322 101 24185       |
| R 10   | POTM, TANDEM+SW.  | 10K 20 0.1W 5322 102 40059       |
| R 101  | RESISTOR, M. FILM | 499 1 MR25 5322 116 54524        |
| R 1101 | RESISTOR, M. FILM | 23.7K 1 MR25 5322 116 54646      |
| R 1102 | RESISTOR, M. FILM | 28.7K 1 MR25 5322 116 54653      |
| R 1103 | RESISTOR, M. FILM | 5.62K 1 MR25 4822 116 51281      |
| R 1104 | RESISTOR, M. FILM | 3.16K 1 MR25 5322 116 50579      |
| R 1106 | POTM, TRIMMING    | 22K 20 0.5W 5322 100 10118       |
| R 1107 | POTM, TRIMMING    | 22K 20 0.5W 5322 100 10118       |
| Q 1108 | POTM, TRIMMING    | 22K 20 0.5W 5322 100 10118       |
| R 1109 | RESISTOR, M. FILM | 1K 1 MR25 4822 116 51235         |
| R 1111 | RESISTOR, M. FILM | 23.7K 1 MR25 5322 116 54646      |
| R 1112 | RESISTOR, M. FILM | 14.7K 1 MR25 5322 116 54632      |
| R 1113 | RESISTOR, M. FILM | 1.1K 1 MR25 4822 116 51236       |
| R 1114 | RESISTOR, M. FILM | 1K 1 MR25 4822 116 51235         |
| R 1116 | RESISTOR, M. FILM | 825 1 MR25 5322 116 54541        |
| R 1117 | RESISTOR, M. FILM | 14.7K 1 MR25 5322 116 54632      |
| R 1118 | RESISTOR, M. FILM | 316 1 MR25 5322 116 54511        |
| R 1119 | RESISTOR, M. FILM | 1.1K 1 MR25 4822 116 51236       |
| O 1121 | RESISTOR, M. FILM | 4.64K 1 MR25 5322 116 50484      |
| R 1122 | RESISTOR, M. FILM | 10K 1 MR25 4822 116 51253        |
| R 1123 | RESISTOR, M. FILM | 562 1 MR25 4822 116 51231        |
| R 1124 | RESISTOR, M. FILM | 2.15K 1 MR25 5322 116 50767      |
| R 1126 | RESISTOR, M. FILM | 100 1 MR25 5322 116 55549        |
| R 1127 | RESISTOR, M. FILM | 1K 1 MR25 4822 116 51235         |
| R 1128 | RESISTOR, M. FILM | 42.2 1 MR25 5322 116 51052       |
| R 1129 | RESISTOR, M. FILM | 1K 1 MR25 4822 116 51235         |
| R 1131 | RESISTOR, M. FILM | 365 1 MR25 5322 116 54516        |
| R 1132 | RESISTOR, M. FILM | 2.15K 1 MR25 5322 116 50767      |
| R 1133 | RESISTOR, M. FILM | 42.2K 1 MR25 5322 116 50474      |
| R 1134 | RESISTOR, M. FILM | 17.8 1 MR25 5322 116 50418       |
| R 1136 | RESISTOR, NTC     | 6.8K 10 0.5W 5322 116 34058      |
| R 1137 | RESISTOR, NTC     | 6.8K 10 0.5W 5322 116 34058      |

| POSNR  | DESCRIPTION       | ORDERING CODE               |
|--------|-------------------|-----------------------------|
| R 1138 | RESISTOR, M. FILM | 42.2K 1 MR25 5322 116 50474 |
| R 1139 | RESISTOR, M. FILM | 2.15K 1 MR25 5322 116 50767 |
| R 1141 | RESISTOR, M. FILM | 10K 1 MR25 4822 116 51253   |
| R 1142 | RESISTOR, M. FILM | 562 1 MR25 4822 116 51231   |
| R 1143 | RESISTOR, M. FILM | 2.15K 1 MR25 5322 116 50767 |
| R 1144 | RESISTOR, M. FILM | 365 1 MR25 5322 116 54518   |
| R 1146 | RESISTOR, M. FILM | 17.8 1 MR25 5322 116 51052  |
| R 1147 | RESISTOR, M. FILM | 42.2 1 MR25 5322 116 55549  |
| R 1148 | RESISTOR, M. FILM | 100 1 MR25 4822 116 51282   |
| R 1149 | RESISTOR, M. FILM | 511 1 MR25 4822 116 51282   |
| R 1151 | RESISTOR, M. FILM | 2.15K 1 MR25 5322 116 50767 |
| R 1152 | RESISTOR, M. FILM | 23.7K 1 MR25 5322 116 54646 |
| R 1153 | RESISTOR, M. FILM | 215 1 MR25 5322 116 55274   |
| R 1154 | RESISTOR, M. FILM | 1.1K 1 MR25 4822 116 51236  |
| R 1156 | RESISTOR, M. FILM | 825 1 MR25 5322 116 54541   |
| R 1157 | RESISTOR, M. FILM | 1.1K 1 MR25 4822 116 51236  |
| R 12   | POTM, TANDEM+SW.  | 10K 20 5322 102 40058       |
| R 1201 | RESISTOR, M. FILM | 10K 1 MR25 4822 116 51253   |
| R 1202 | RESISTOR, M. FILM | 100K 1 MR25 4822 116 51263  |
| R 1203 | RESISTOR, M. FILM | 100K 1 MR25 4822 116 51268  |
| R 1204 | RESISTOR, M. FILM | 332K 1 MR25 4822 116 51184  |
| R 1205 | RESISTOR, M. FILM | 82.5 1 MR25 5322 116 54882  |
| R 1206 | RESISTOR, M. FILM | 22.6K 1 MR25 5322 116 54575 |
| R 1208 | RESISTOR, M. FILM | 316 1 MR25 5322 116 54511   |
| R 1209 | RESISTOR, M. FILM | 2.26K 1 MR25 5322 116 50675 |
| R 1210 | RESISTOR, M. FILM | 82.5 1 MR25 5322 116 54462  |
| R 1211 | RESISTOR, M. FILM | 2.26K 1 MR25 5322 116 50675 |
| R 1212 | RESISTOR, M. FILM | 2.26K 1 MR25 5322 116 50675 |
| R 1213 | RESISTOR, M. FILM | 133 1 MR25 5322 116 54482   |
| R 1214 | RESISTOR, M. FILM | 2.26K 1 MR25 5322 116 50675 |
| R 1215 | RESISTOR, M. FILM | 316 1 MR25 5322 116 54511   |
| R 1216 | RESISTOR, M. FILM | 316 1 MR25 5322 116 54511   |
| R 1217 | RESISTOR, M. FILM | 316 1 MR25 5322 116 54511   |
| R 1218 | RESISTOR, M. FILM | 2.26K 1 MR25 5322 116 50675 |
| R 1219 | RESISTOR, M. FILM | 2.26K 1 MR25 5322 116 50675 |
| R 1220 | RESISTOR, M. FILM | 316 1 MR25 5322 116 54511   |
| R 1221 | RESISTOR, M. FILM | 2.26K 1 MR25 5322 116 50675 |
| R 1222 | RESISTOR, M. FILM | 2.26K 1 MR25 5322 116 50675 |
| R 1223 | RESISTOR, M. FILM | 2.26K 1 MR25 5322 116 50675 |
| R 1224 | RESISTOR, M. FILM | 2.26K 1 MR25 5322 116 50675 |
| Q 1225 | RESISTOR, M. FILM | 4.87K 1 MR25 5322 116 55445 |
| R 1226 | RESISTOR, M. FILM | 2.26K 1 MR25 5322 116 50675 |
| R 1227 | RESISTOR, M. FILM | 2.26K 1 MR25 5322 116 50675 |
| R 1228 | RESISTOR, M. FILM | 2.26K 1 MR25 5322 116 50675 |
| R 1229 | RESISTOR, M. FILM | 681 1 MR25 4822 116 51233   |
| R 1230 | RESISTOR, M. FILM | 3.01K 1 MR25 4822 116 51246 |
| R 1301 | RESISTOR, M. FILM | 133 1 MR25 5322 116 54482   |
| R 1302 | RESISTOR, M. FILM | 82.5 1 MR25 5322 116 54462  |
| R 1303 | RESISTOR, M. FILM | 205 1 MR25 5322 116 55365   |
| R 1304 | RESISTOR, M. FILM | 205 1 MR25 5322 116 55365   |
| R 1308 | RESISTOR, M. FILM | 205 1 MR25 5322 116 55285   |
| Q 1308 | RESISTOR, M. FILM | 1K 1 MR25 4822 116 51235    |
| R 1309 | RESISTOR, M. FILM | 1K 1 MR25 4822 116 51235    |
| R 1311 | RESISTOR, M. FILM | 5.11K 1 MR25 5322 116 54595 |
| R 1312 | RESISTOR, M. FILM | 2.26K 1 MR25 5322 116 50675 |
| R 1313 | RESISTOR, M. FILM | 2.26K 1 MR25 5322 116 50675 |
| R 1314 | RESISTOR, M. FILM | 2.26K 1 MR25 5322 116 50675 |
| R 1316 | RESISTOR, M. FILM | 2.26K 1 MR25 5322 116 50675 |
| R 1317 | RESISTOR, M. FILM | 2.26K 1 MR25 5322 116 50675 |
| R 1318 | RESISTOR, M. FILM | 2.26K 1 MR25 5322 116 50675 |
| R 1319 | RESISTOR, M. FILM | 2.26K 1 MR25 5322 116 50675 |
| R 1322 | RESISTOR, M. FILM | 1K 1 MR25 4822 116 51235    |
| R 1323 | RESISTOR, M. FILM | 1K 1 MR25 4822 116 51235    |



| PCSNR  | DESCRIPTION             | ORDERING CODE          |
|--------|-------------------------|------------------------|
| R 1324 | RESISTOR, M. FILM 2.26K | 1 MR25 5322 116 50675  |
| R 1326 | RESISTOR, M. FILM 2.26K | 1 MR25 5322 116 50675  |
| R 1327 | RESISTOR, M. FILM 10    | 1 MR25 5322 116 50452  |
| R 1328 | RESISTOR, M. FILM 10    | 1 MR25 5322 116 50452  |
| R 1329 | RESISTOR, M. FILM 10K   | 1 MR25 4822 116 51253  |
| R 1331 | RESISTOR, M. FILM 30.1K | 1 MR25 5322 116 54655  |
| R 1332 | RESISTOR, M. FILM 10K   | 1 MR25 4822 116 51253  |
| R 1333 | RESISTOR, M. FILM 4.02K | 1 MR25 5322 116 55448  |
| R 1334 | RESISTOR, M. FILM 2.74K | 1 MR25 5322 116 50636  |
| R 1336 | RESISTOR, M. FILM 681   | 1 MR25 4822 116 51233  |
| R 1337 | RESISTOR, M. FILM 1K    | 1 MR25 4822 116 51235  |
| R 1338 | RESISTOR, M. FILM 4.02K | 1 MR25 5322 116 55448  |
| R 14   | POTM, CARB+SW. 100K     | 20 5322 101 44037      |
| R 15   | POTM, CARBON 47K        | 20 0.1W 5322 101 24203 |
| R 1501 | RESISTOR, M. FILM 31.6K | 1 MR25 5322 116 54657  |
| R 1502 | RESISTOR, HT 6.8M       | 5 VR37 4822 110 42209  |
| R 1503 | RESISTOR, M. FILM 402   | 1 MR25 5322 116 54519  |
| R 1504 | RESISTOR, HT 31.6M      | 1 VR37 5322 116 64103  |
| R 1506 | POTM, TRIMMING 1M       | 20 0.5W 5322 101 14068 |
| 4 1507 | RESISTOR, PTC 4822      | 116 40031              |
| R 1508 | RESISTOR, M. FILM 10K   | 1 MR25 4822 116 51253  |
| R 1509 | RESISTOR, HT 2.2M       | 5 VR37 4822 110 42196  |
| R 1511 | RESISTOR, M. FILM 4.64K | 1 MR25 5322 116 50484  |
| R 1512 | RESISTOR, M. FILM 7.5   | 1 MR25 5322 116 54417  |
| R 1513 | RESISTOR, M. FILM 7.5   | 1 MR25 5322 116 54417  |
| R 1514 | RESISTOR, M. FILM 10K   | 1 MR25 4822 116 51253  |
| R 1516 | RESISTOR, M. FILM 402K  | 1 MR25 5322 116 55283  |
| R 1517 | RESISTOR, M. FILM 1M    | 1 MR25 5322 116 55535  |
| R 1518 | RESISTOR, M. FILM 402K  | 1 MR25 5322 116 55283  |
| R 1519 | RESISTOR, M. FILM 1M    | 1 MR25 5322 116 55535  |
| R 1521 | RESISTOR, M. FILM 511   | 1 MR25 4822 116 51282  |
| R 1522 | RESISTOR, HT 10M        | 1 VR37 4822 110 42214  |
| R 1523 | RESISTOR, M. FILM 226   | 1 MR25 5322 116 54497  |
| R 1524 | RESISTOR, M. FILM 226   | 1 MR25 5322 116 54497  |
| R 1526 | RESISTOR, M. FILM 5.11K | 1 MR25 5322 116 54595  |
| R 1527 | RESISTOR, M. FILM 5.11  | 1 MR25 5322 116 54192  |
| R 1528 | RESISTOR, M. FILM 5.11  | 1 MR25 5322 116 54192  |
| R 1529 | RESISTOR, M. FILM 5.11  | 1 MR25 5322 116 54192  |
| R 1531 | RESISTOR, M. FILM 1M    | 1 MR25 5322 116 55535  |
| R 1532 | RESISTOR, M. FILM 1.33K | 1 MR25 5322 116 55422  |
| R 1533 | RESISTOR, M. FILM 1.33K | 1 MR25 5322 116 55622  |
| R 1534 | RESISTOR, M. FILM 1K    | 1 MR25 4822 116 51235  |
| R 1536 | RESISTOR, M. FILM 511K  | 1 MR25 5322 116 55258  |
| R 1537 | RESISTOR, M. FILM 68.1K | 1 MR25 5322 116 54683  |
| R 1538 | RESISTOR, M. FILM 68.1K | 1 MR25 5322 116 54683  |
| R 1539 | RESISTOR, M. FILM 22.6K | 1 MR25 5322 116 50481  |
| R 1541 | RESISTOR, M. FILM 681K  | 1 MR25 5322 116 55284  |
| R 1542 | RESISTOR, M. FILM 100   | 1 MR25 5322 116 55549  |
| R 1543 | RESISTOR, M. FILM 103   | 1 MR25 5322 116 55549  |
| R 1544 | RESISTOR, M. FILM 5.11K | 1 MR25 5322 116 54595  |
| R 1546 | RESISTOR, M. FILM 121   | 1 MR25 5322 116 54426  |
| R 1547 | RESISTOR, M. FILM 82.5  | 1 MR25 5322 116 54462  |
| R 1548 | RESISTOR, M. FILM 825   | 1 MR25 5322 116 54541  |
| 4 1549 | RESISTOR, M. FILM 1K    | 1 MR25 4822 116 51235  |
| R 1551 | RESISTOR, M. FILM 249K  | 1 MR25 5322 116 54734  |
| R 1552 | RESISTOR, M. FILM 3.48K | 1 MR25 5322 116 55367  |
| R 1553 | RESISTOR, M. FILM 68.1K | 1 MR25 5322 116 54683  |
| R 1554 | RESISTOR, M. FILM 40.2K | 1 MR25 5322 116 54665  |
| R 1556 | RESISTOR, M. FILM 274   | 1 MR25 5322 116 54504  |
| R 1557 | RESISTOR, M. FILM 21.5K | 1 MR25 5322 116 50451  |
| R 1558 | RESISTOR, M. FILM 15.4K | 1 MR25 5322 116 55459  |
| R 1559 | RESISTOR, M. FILM 1.33K | 1 MR25 5322 116 55422  |
| R 1561 | RESISTOR, M. FILM 825   | 1 MR25 5322 116 54541  |
| R 1562 | RESISTOR, M. FILM 274   | 1 MR25 5322 116 54504  |
| R 1563 | RESISTOR, M. FILM 36.5K | 1 MR25 5322 116 50726  |

| POSNR  | DESCRIPTION             | ORDERING CODE             |
|--------|-------------------------|---------------------------|
| R 1564 | RESISTOR, M. FILM 6.81K | 1 MR25 4822 116 51252     |
| R 1566 | RESISTOR, M. FILM 22.6K | 1 MR25 5322 116 50481     |
| R 1567 | RESISTOR, M. FILM 22.6K | 1 MR25 4822 116 51246     |
| R 1568 | RESISTOR, M. FILM 30.1K | 1 MR25 5322 116 54655     |
| R 1569 | RESISTOR, M. FILM 30.1K | 1 MR25 5322 116 54655     |
| R 1571 | RESISTOR, M. FILM 26.1K | 1 MR25 5322 116 54651     |
| R 1572 | RESISTOR, M. FILM 6.81K | 1 MR25 4822 116 51252     |
| R 1573 | RESISTOR, M. FILM 11K   | 1 MR25 5322 116 54623     |
| R 1574 | RESISTOR, M. FILM 3.01K | 1 MR25 4822 116 51246     |
| R 1576 | RESISTOR, M. FILM 10K   | 1 MR25 4822 116 51253     |
| R 1577 | RESISTOR, M. FILM 8.25K | 1 MR25 5322 116 54558     |
| R 1578 | RESISTOR, SAFETY 7.37K  | 1 MR25 5322 116 50458     |
| R 1579 | RESISTOR, M. FILM 1M    | 1 MR25 5322 116 55535     |
| R 1581 | RESISTOR, M. FILM 10K   | 1 MR25 4822 116 51253     |
| R 1582 | RESISTOR, M. FILM 3.01K | 1 MR25 4822 116 51246     |
| R 1583 | RESISTOR, M. FILM 3.01K | 1 MR25 4822 116 51246     |
| R 1584 | RESISTOR, M. FILM 3.01K | 1 MR25 4822 116 51246     |
| R 1586 | POTM, TRIMMING 13.7K    | 1 MR25 5322 116 55362     |
| R 1587 | POTM, TRIMMING 47K      | 20 0.5W 5322 101 14293    |
| R 1588 | POTM, TRIMMING 2.2K     | 20 0.5W 5322 100 10117    |
| R 1589 | POTM, TRIMMING 2.2K     | 20 0.5W 5322 100 10117    |
| R 1591 | POTM, TRIMMING 1K       | 20 0.5W 5322 101 10294    |
| R 1592 | RESISTOR, M. FILM 18.7K | 1 MR25 5322 116 55362     |
| X 16   | POTM, CARBON 4.7K       | 20 0.1W 5322 101 24186    |
| R 1601 | RESISTOR, M. FILM 301K  | 1 MR25 5322 116 54743     |
| R 1602 | RESISTOR, M. FILM 301K  | 1 MR25 5322 116 54743     |
| R 1603 | RESISTOR, M. FILM 2K    | 5 PR52 5322 116 55205     |
| R 1604 | RESISTOR, M. FILM 20    | 5 PR52 5322 116 54351     |
| R 1605 | RESISTOR, M. FILM 22.6  | 1 MR25 5322 116 50491     |
| R 1606 | RESISTOR, M. FILM 110K  | 0.1 MR25 5322 116 51696   |
| R 1607 | RESISTOR, M. FILM 20.5K | 1 MR25 5322 116 54643     |
| R 1608 | RESISTOR, M. FILM 100K  | 1 MR25 4822 116 51268     |
| R 1609 | RESISTOR, M. FILM 40.2K | 1 MR25 5322 116 54665     |
| R 1611 | RESISTOR, M. FILM 22.6K | 1 MR25 5322 116 50481     |
| R 1612 | RESISTOR, M. FILM 33.2K | 1 MR25 4822 116 51259     |
| R 1613 | RESISTOR, HT 1M         | 5 VR37 4822 110 42187     |
| R 1614 | RESISTOR, M. FILM 215K  | 0.1 MR25 5322 116 51697   |
| R 1616 | RESISTOR, MW 3.3K       | 5 4W 4822 112 21121       |
| R 1617 | RESISTOR, HT 1M         | 5 VR37 4822 110 42187     |
| R 1618 | RESISTOR, M. FILM 215K  | 0.1 MR25 5322 116 51697   |
| R 1619 | RESISTOR, M. FILM 27K   | 5 PR52 5322 116 54983     |
| R 1620 | RESISTOR, M. FILM 1.54K | 1 MR25 5322 116 50586     |
| R 1621 | RESISTOR, M. FILM 27K   | 5 PR52 5322 116 54983     |
| R 1622 | RESISTOR, M. FILM 110K  | 0.1 MR25 5322 116 51696   |
| R 1623 | RESISTOR, M. FILM 24.9K | 1 MR25 5322 116 54648     |
| R 1624 | RESISTOR, M. FILM 6.81K | 1 MR25 4822 116 51252     |
| R 1626 | RESISTOR, M. FILM 249   | 1 MR25 5322 116 54499     |
| R 1627 | RESISTOR, M. FILM 1     | 1 MR25 4822 116 51179     |
| R 1628 | RESISTOR, M. FILM 100   | 1 MR25 5322 116 55549     |
| R 1629 | RESISTOR, M. FILM 10    | 1 MR25 5322 116 50452     |
| R 1631 | RESISTOR, M. FILM 1K5   | 25% 1 MR25 5322 116 34051 |
| R 1632 | RESISTOR, M. FILM 12.1K | 1 MR25 5322 116 50572     |
| R 1633 | RESISTOR, M. FILM 825   | 1 MR25 5322 116 54541     |
| R 1634 | RESISTOR, M. FILM 140   | 1 MR25 5322 116 55568     |
| R 1636 | RESISTOR, M. FILM 249   | 1 MR25 5322 116 54499     |
| R 1637 | RESISTOR, M. FILM 3.32K | 1 MR25 5322 116 54005     |
| R 1638 | RESISTOR, M. FILM 2.26K | 1 MR25 5322 116 50675     |
| R 1639 | RESISTOR, M. FILM 4.87K | 1 MR25 5322 116 55445     |
| R 1641 | RESISTOR, M. FILM 4.64K | 1 MR25 5322 116 50484     |
| R 1642 | RESISTOR, M. FILM 16.2K | 1 MR25 5322 116 55361     |
| R 1643 | RESISTOR, M. FILM 100K  | 1 MR25 4822 116 51268     |
| R 1644 | RESISTOR, M. FILM 5.11  | 1 MR25 5322 116 54192     |
| R 1646 | POTM, TRIMMING 470      | 20 0.5W 5322 101 14049    |
| R 1647 | POTM, TRIMMING 4.7K     | 20 0.5W 5322 101 14292    |
| R 1648 | RESISTOR, M. FILM 4.42K | 1 MR25 5322 116 50556     |

| POSNR  | DESCRIPTION       |       |    | ORDERING | CODE           |
|--------|-------------------|-------|----|----------|----------------|
| R 2    | POTM, CARB+SW     | 10K   | 20 | 0.1W     | 5322 101 44049 |
| R 2001 | RESISTOR, M. FILM | 681K  | 1  | MR25     | 5322 116 55284 |
| R 2002 | RESISTOR, M. FILM | 681K  | 1  | MR25     | 5322 116 55284 |
| R 2003 | RESISTOR, M. FILM | 681K  | 1  | MR25     | 5322 116 55284 |
| R 2004 | RESISTOR, M. FILM | 681K  | 1  | MR25     | 5322 116 55284 |
| R 2006 | RESISTOR, M. FILM | 681K  | 1  | MR25     | 5322 116 55284 |
| R 2007 | RESISTOR, M. FILM | 681K  | 1  | MR25     | 5322 116 55284 |
| R 2008 | POTM, TRIMMING    | 2.2K  | 20 | 0.5W     | 5322 100 10117 |
| R 2009 | POTM, TRIMMING    | 4.7K  | 20 | 0.5W     | 5322 101 14292 |
| R 201  | RESISTOR, M. FILM | 237   | 1  | MR25     | 5322 116 50679 |
| R 2011 | POTM, TRIMMING    | 47K   | 20 | 0.5W     | 5322 101 14293 |
| R 2012 | RESISTOR, M. FILM | 3,16K | 1  | MR25     | 5322 116 50579 |
| R 2013 | RESISTOR, M. FILM | 16,9K | 1  | MR25     | 5322 116 54635 |
| R 2014 | RESISTOR, M. FILM | 10K   | 1  | MR25     | 4822 116 51253 |
| R 2016 | RESISTOR, M. FILM | 511   | 1  | MR25     | 4822 116 51282 |
| R 2017 | POTM, TRIMMING    | 1K    | 20 | 0.5W     | 5322 101 10294 |
| R 2018 | POTM, TRIMMING    | 4.7K  | 20 | 0.5W     | 5322 101 14292 |
| R 2019 | POTM, TRIMMING    | 22K   | 20 | 0.5W     | 5322 100 10118 |
| R 202  | RESISTOR, M. FILM | 237   | 1  | MR25     | 5322 116 50679 |
| R 2021 | RESISTOR, M. FILM | 20,5K | 1  | MR25     | 5322 116 54643 |
| R 2022 | RESISTOR, M. FILM | 10K   | 1  | MR25     | 4822 116 51253 |
| R 2023 | RESISTOR, M. FILM | 19,6K | 1  | MR25     | 5322 116 54641 |
| R 2024 | RESISTOR, M. FILM | 10K   | 1  | MR25     | 4822 116 51253 |
| R 2026 | RESISTOR, M. FILM | 3,32K | 1  | MR25     | 5322 116 54005 |
| R 2027 | RESISTOR, M. FILM | 178   | 1  | MR25     | 5322 116 54492 |
| R 2028 | RESISTOR, M. FILM | 10K   | 1  | MR25     | 4822 116 51253 |
| R 2029 | RESISTOR, M. FILM | 10K   | 1  | MR25     | 4822 116 51253 |
| R 203  | RESISTOR, M. FILM | 237   | 1  | MR25     | 5322 116 50679 |
| R 2031 | RESISTOR, M. FILM | 23,7K | 1  | MR25     | 5322 116 54646 |
| R 2032 | RESISTOR, M. FILM | 10K   | 1  | MR25     | 4822 116 51253 |
| R 2033 | RESISTOR, M. FILM | 10K   | 1  | MR25     | 4822 116 51253 |
| R 2034 | RESISTOR, M. FILM | 10K   | 1  | MR25     | 4822 116 51253 |
| R 2036 | RESISTOR, M. FILM | 100K  | 1  | MR25     | 4822 116 51268 |
| R 2037 | RESISTOR, M. FILM | 5,36K | 1  | MR25     | 5322 116 54597 |
| R 2038 | RESISTOR, M. FILM | 1K    | 1  | MR25     | 4822 116 51235 |
| R 2039 | POTM, TRIMMING    | 4.7K  | 20 | 0.5W     | 5322 101 14292 |
| R 204  | RESISTOR, M. FILM | 237   | 1  | MR25     | 5322 116 50679 |
| R 2041 | RESISTOR, M. FILM | 5,36K | 1  | MR25     | 5322 116 54597 |
| R 2042 | RESISTOR, M. FILM | 10K   | 1  | MR25     | 4822 116 51253 |
| R 2043 | RESISTOR, M. FILM | 1,87K | 1  | MR25     | 5322 116 50728 |
| R 2044 | RESISTOR, M. FILM | 22,6K | 1  | MR25     | 5322 116 50481 |
| R 2046 | RESISTOR, M. FILM | 2,05K | 1  | MR25     | 5322 116 50664 |
| R 2047 | RESISTOR, M. FILM | 100   | 1  | MR25     | 5322 116 55549 |
| R 2048 | RESISTOR, M. FILM | 24,9K | 1  | MR25     | 5322 116 54648 |
| R 2049 | RESISTOR, M. FILM | 154K  | 1  | MR25     | 5322 116 54714 |
| R 2051 | RESISTOR, M. FILM | 154K  | 1  | MR25     | 5322 116 54714 |
| R 2052 | RESISTOR, M. FILM | 1K    | 1  | MR25     | 4822 116 51235 |
| R 2053 | RESISTOR, M. FILM | 10K   | 1  | MR25     | 4822 116 51253 |
| R 2056 | RESISTOR, M. FILM | 10K   | 1  | MR25     | 4822 116 51253 |
| R 2056 | RESISTOR, M. FILM | 10K   | 1  | MR25     | 4822 116 51253 |
| R 2057 | RESISTOR, M. FILM | 51,1K | 1  | MR25     | 5322 116 50672 |
| R 2058 | RESISTOR, M. FILM | 51,1K | 1  | MR25     | 5322 116 50672 |
| R 2059 | RESISTOR, M. FILM | 10K   | 1  | MR25     | 4822 116 51253 |
| R 206  | RESISTOR, M. FILM | 237   | 1  | MR25     | 5322 116 50679 |
| R 2061 | RESISTOR, M. FILM | 10K   | 1  | MR25     | 4822 116 51253 |
| R 2062 | TOR, M. F. M      | 10K   | 1  | MR25     | 4822 116 51253 |
| R 2063 | TOR, M. F. M      | 154K  | 1  | MR25     | 5322 116 54714 |
| R 2064 | TOR, M. F. M      | 511K  | 1  | MR25     | 5322 116 55258 |
| R 2066 | TOR, M. F. M      | 7,15K | 1  | MR25     | 5322 116 54606 |
| R 2067 | TOR, M. F. M      | 7,15K | 1  | MR25     | 5322 116 54606 |
| R 2068 | RESISTOR, M. FILM | 100K  | 1  | MR25     | 4822 116 51268 |
| R 2069 | RESISTOR, M. FILM | 3,83K | 1  | MR25     | 5322 116 54589 |
| R 207  | RESISTOR, M. FILM | 237   | 1  | MR25     | 5322 116 50679 |
| R 2071 | RESISTOR, M. FILM | 169K  | 1  | MR25     | 5322 116 54718 |
| R 2072 | POTM, TRIMMING    | 100K  | 20 | 0.5W     | 5322 100 10116 |

| POSNR  | DESCRIPTION       |       |   | ORDERING | CODE           |
|--------|-------------------|-------|---|----------|----------------|
| R 2073 | RESISTOR, M. FILM | 10K   | 1 | MR25     | 4822 116 51253 |
| R 2074 | RESISTOR, M. FILM | 7,15K | 1 | MR25     | 5322 116 54606 |
| R 2076 | RESISTOR, M. FILM | 3,83K | 1 | MR25     | 5322 116 54589 |
| R 2077 | RESISTOR, M. FILM | 10K   | 1 | MR25     | 4822 116 51253 |
| R 2078 | RESISTOR, M. FILM | 7,15K | 1 | MR25     | 5322 116 54606 |
| R 2079 | RESISTOR, M. FILM | 1,96K | 1 | MR25     | 5322 116 54571 |
| R 208  | RESISTOR, M. FILM | 237   | 1 | MR25     | 5322 116 50679 |
| R 2080 | RESISTOR, M. FILM | 3,83K | 1 | MR25     | 5322 116 54589 |
| R 2081 | RESISTOR, M. FILM | 1,96K | 1 | MR25     | 5322 116 54571 |
| R 2082 | RESISTOR, M. FILM | 6,19K | 1 | MR25     | 5322 116 55426 |
| R 2083 | RESISTOR, M. FILM | 301K  | 1 | MR25     | 5322 116 54743 |
| R 2084 | RESISTOR, M. FILM | 24,9K | 1 | MR25     | 5322 116 54648 |
| R 2485 | RESISTOR, M. FILM | 3,83K | 1 | MR25     | 5322 116 54589 |
| R 2686 | RESISTOR, M. FILM | 100K  | 1 | MR25     | 4822 116 51268 |
| R 2087 | RESISTOR, M. FILM | 5,36K | 1 | MR25     | 5322 116 54597 |
| R 2088 | RESISTOR, M. FILM | 154K  | 1 | MR25     | 5322 116 54714 |
| R 2089 | RESISTOR, M. FILM | 10K   | 1 | MR25     | 4822 116 51253 |
| R 209  | RESISTOR, M. FILM | 237   | 1 | MR25     | 5322 116 50679 |
| R 2091 | RESISTOR, M. FILM | 5,36K | 1 | MR25     | 5322 116 54597 |
| R 2092 | RESISTOR, M. FILM | 154K  | 1 | MR25     | 5322 116 54714 |
| R 2093 | RESISTOR, M. FILM | 1,78K | 1 | MR25     | 5322 116 50515 |
| R 2094 | RESISTOR, M. FILM | 3,01K | 1 | MR25     | 4822 116 51246 |
| R 2096 | RESISTOR, M. FILM | 10K   | 1 | MR25     | 4822 116 51253 |
| R 2097 | RESISTOR, M. FILM | 154K  | 1 | MR25     | 5322 116 54714 |
| R 2098 | RESISTOR, M. FILM | 2,37K | 1 | MR25     | 5322 116 54576 |
| R 2099 | RESISTOR, M. FILM | 15,4K | 1 | MR25     | 5322 116 55459 |
| R 2101 | RESISTOR, M. FILM | 30,1K | 1 | MR25     | 5322 116 54655 |
| R 2102 | RESISTOR, M. FILM | 953   | 1 | MR25     | 5322 116 54547 |
| R 2103 | RESISTOR, M. FILM | 2,37K | 1 | MR25     | 5322 116 54576 |
| R 2104 | RESISTOR, M. FILM | 5,11  | 1 | MR25     | 5322 116 54192 |
| R 2106 | RESISTOR, M. FILM | 5,11  | 1 | MR25     | 5322 116 54192 |
| R 2107 | RESISTOR, M. FILM | 16,2K | 1 | MR25     | 5322 116 55361 |
| R 2108 | RESISTOR, M. FILM | 5,11  | 1 | MR25     | 5322 116 54192 |
| R 2109 | RESISTOR, M. FILM | 487   | 1 | MR25     | 5322 116 55451 |
| R 211  | RESISTOR, M. FILM | 237   | 1 | MR25     | 5322 116 50679 |
| R 2111 | RESISTOR, M. FILM | 2,74K | 1 | MR25     | 5322 116 50636 |
| R 2112 | RESISTOR, M. FILM | 10,5K | 1 | MR25     | 5322 116 50731 |
| R 2113 | RESISTOR, M. FILM | 5,11  | 1 | MR25     | 5322 116 54192 |
| R 2114 | RESISTOR, M. FILM | 5,11  | 1 | MR25     | 5322 116 54192 |
| R 2116 | RESISTOR, M. FILM | 5,11K | 1 | MR25     | 5322 116 54595 |
| R 2117 | RESISTOR, M. FILM | 5,11  | 1 | MR25     | 5322 116 54192 |
| 2 2118 | RESISTOR, M. FILM | 75K   | 1 | MR25     | 4822 116 51267 |
| R 2119 | RESISTOR, M. FILM | 5,11  | 1 | MR25     | 5322 116 54192 |
| R 212  | RESISTOR, M. FILM | 237   | 1 | MR25     | 5322 116 50679 |
| R 2121 | RESISTOR, M. FILM | 10K   | 1 | MR25     | 4822 116 51253 |
| R 2122 | RESISTOR, M. FILM | 3,01K | 1 | MR25     | 4822 116 51246 |
| R 2123 | RESISTOR, M. FILM | 20,5K | 1 | MR25     | 4822 116 54863 |
| R 2124 | RESISTOR, M. FILM | 10K   | 1 | MR25     | 5322 116 54192 |
| R 2126 | RESISTOR, M. FILM | 5,11  | 1 | MR25     | 5322 116 54192 |
| R 213  | RESISTOR, M. FILM | 237   | 1 | MR25     | 5322 116 50679 |
| R 214  | RESISTOR, M. FILM | 1,15K | 1 | MR25     | 5322 116 50415 |
| R 216  | RESISTOR, M. FILM | 1,15K | 1 | MR25     | 5322 116 50415 |
| R 217  | RESISTOR, M. FILM | 1,15K | 1 | MR25     | 5322 116 50415 |
| R 218  | RESISTOR, M. FILM | 1,15K | 1 | MR25     | 5322 116 50415 |
| R 219  | RESISTOR, M. FILM | 1,15K | 1 | MR25     | 5322 116 50415 |
| R 221  | RESISTOR, M. FILM | 1,15K | 1 | MR25     | 5322 116 50415 |
| R 222  | RESISTOR, M. FILM | 237   | 1 | MR25     | 5322 116 50679 |
| R 223  | RESISTOR, M. FILM | 237   | 1 | MR25     | 5322 116 50679 |
| R 231  | RESISTOR, M. FILM | 20,5K | 1 | MR25     | 5322 116 54643 |
| R 232  | RESISTOR, M. FILM | 20,5K | 1 | MR25     | 5322 116 54643 |
| R 2400 | RESISTOR, HT      | 5,6M  | 5 | VR25     | 4822 110 72207 |
| R 2401 | RESISTOR, M. FILM | 100K  | 1 | MR25     | 4822 116 51268 |
| R 2402 | RESISTOR, M. FILM | 100K  | 1 | MR25     | 4822 116 51268 |
| R 2403 | RESISTOR, M. FILM | 100K  | 1 | MR25     | 4822 116 51268 |
| R 2404 | RESISTOR, M. FILM | 100K  | 1 | MR25     | 4822 116 51268 |

| POSHR  | DESCRIPTION       |       |     | ORDERING CODE         |
|--------|-------------------|-------|-----|-----------------------|
| R 2405 | RESISTOR, M. FILM | 3.25  | 1   | MR25 5322 116 54099   |
| R 2406 | RESISTOR, M. FILM | 33.2K | 1   | MR25 4822 116 51259   |
| R 2407 | RESISTOR, M. FILM | 10.5K | 1   | MR25 5322 116 50731   |
| R 2408 | RESISTOR, M. FILM | 7.5K  | 1   | MR25 5322 116 54608   |
| R 2409 | RESISTOR, M. FILM | 2.15K | 1   | MR25 5322 116 50767   |
| R 241  | RESISTOR, M. FILM | 6.81K | 1   | MR25 4822 116 51252   |
| R 2410 | RESISTOR, HT      | 1.5M  | 5   | VR25 4822 110 72192   |
| R 2411 | POTM, TRIMMING    | 2.2K  | 20  | 0.5W 5322 101 14008   |
| R 2412 | RESISTOR, M. FILM | 2.05K | 1   | MR25 5322 116 50664   |
| R 2413 | RESISTOR, M. FILM | 992K  | 0.5 | SPEC 5322 116 55153   |
| R 2414 | RESISTOR, M. FILM | 51.1  | 1   | MR25 5322 116 54442   |
| R 2415 | RESISTOR, HT      | 3.3M  | 5   | VR25 4822 110 72201   |
| R 2416 | POTM, TRIMMING    | 22K   | 20  | 0.5W 5322 101 14069   |
| R 2417 | RESISTOR, M. FILM | 2.87K | 1   | MR25 5322 116 50414   |
| R 2418 | RESISTOR, M. FILM | 100   | 1   | MR25 5322 116 55549   |
| R 2419 | RESISTOR, M. FILM | 1K    | 1   | MR25 4822 116 51235   |
| R 242  | RESISTOR, M. FILM | 6.81K | 1   | MR25 4822 116 51252   |
| R 2420 | RESISTOR, M. FILM | 14    | 1   | MR25 5322 116 50839   |
| R 2421 | RESISTOR, M. FILM | 64.9K | 1   | MR25 5322 116 50514   |
| R 2422 | RESISTOR, CARBON  | 560   | 5   | CR16 4822 111 30309   |
| R 2423 | RESISTOR, CARBON  | 10    | 5   | CR16 4822 111 30347   |
| R 2424 | RESISTOR, M. FILM | 1K    | 1   | MR25 4822 116 51235   |
| R 2425 | RESISTOR, M. FILM | 1.54K | 1   | MR25 5322 116 50586   |
| R 2426 | RESISTOR, CARBON  | 100M  | 5   | 0.125W 5322 111 30376 |
| R 2428 | RESISTOR, M. FILM | 287   | 1   | MR25 5322 116 54506   |
| R 2429 | RESISTOR, M. FILM | 287   | 1   | MR25 5322 116 54505   |
| R 243  | RESISTOR, M. FILM | 6.81K | 1   | MR25 4822 116 51252   |
| R 2431 | RESISTOR, M. FILM | 5.36K | 1   | MR25 5322 116 54597   |
| R 2432 | RESISTOR, M. FILM | 71.5K | 1   | MR25 5322 116 54635   |
| R 2433 | RESISTOR, M. FILM | 20.5K | 1   | MR25 5322 116 54643   |
| R 2434 | RESISTOR, M. FILM | 64.9K | 1   | MR25 5322 116 50514   |
| R 2436 | RESISTOR, CARBON  | 33    | 5   | CR16 4822 111 30067   |
| R 2437 | RESISTOR, M. FILM | 64.9  | 1   | MR25 5322 116 54453   |
| R 2438 | RESISTOR, M. FILM | 115   | 1   | MR25 5322 116 54476   |
| R 2439 | RESISTOR, M. FILM | 124   | 1   | MR25 5322 116 54478   |
| R 244  | RESISTOR, M. FILM | 6.81K | 1   | MR25 4822 116 51252   |
| R 2441 | RESISTOR, M. FILM | 261   | 1   | MR25 5322 116 54502   |
| R 2442 | RESISTOR, M. FILM | 10K   | 1   | MR25 4822 116 51253   |
| R 2443 | RESISTOR, M. FILM | 7.15K | 1   | MR25 5322 116 54606   |
| R 2444 | RESISTOR, M. FILM | 5.11  | 1   | MR25 5322 116 54192   |
| R 2445 | RESISTOR, M. FILM | 301K  | 1   | MR25 5322 116 54743   |
| R 2446 | RESISTOR, M. FILM | 21.5K | 1   | MR25 5322 116 50451   |
| R 2447 | RESISTOR, M. FILM | 100   | 1   | MR25 5322 116 55549   |
| R 2448 | RESISTOR, M. FILM | 8.06K | 0.5 | MR25 5322 116 55428   |
| R 2449 | RESISTOR, M. FILM | 2.26K | 1   | MR25 5322 116 50675   |
| R 2450 | RESISTOR, M. FILM | 6.81  | 1   | MR25 5322 116 54013   |
| R 2451 | RESISTOR, M. FILM | 48.7K | 1   | MR25 5322 116 50442   |
| R 2452 | RESISTOR, M. FILM | 105   | 1   | MR25 5322 116 54472   |
| R 2453 | RESISTOR, M. FILM | 95.3  | 1   | MR25 5322 116 50569   |
| R 2454 | RESISTOR, M. FILM | 1.58K | 1   | MR25 5322 116 50622   |
| R 2455 | RESISTOR, M. FILM | 51.1K | 1   | MR25 5322 116 50672   |
| R 2456 | RESISTOR, M. FILM | 95.3  | 1   | MR25 5322 116 50569   |
| R 2457 | RESISTOR, M. FILM | 5.9K  | 1   | MR25 5322 116 50583   |
| R 2458 | RESISTOR, M. FILM | 3.32K | 1   | MR25 5322 116 54005   |
| R 2459 | RESISTOR, CARBON  | 22    | 5   | CR16 5322 111 30396   |
| R 246  | RESISTOR, M. FILM | 6.81K | 1   | MR25 4822 116 51252   |
| R 2461 | RESISTOR, M. FILM | 249K  | 1   | MR25 5322 116 54734   |
| R 2462 | RESISTOR, M. FILM | 22.6  | 1   | MR25 5322 116 50491   |
| R 2463 | RESISTOR, CARBON  | 27    | 5   | CR16 4822 111 30348   |
| R 2464 | RESISTOR, CARBON  | 33    | 5   | CR16 4822 111 30067   |
| R 2465 | RESISTOR, M. FILM | 1M    | 1   | MR25 5322 116 55535   |
| R 2466 | RESISTOR, M. FILM | 306K  | 0.5 | MR25 5322 116 51369   |
| R 2467 | RESISTOR, M. FILM | 226K  | 1   | MR25 5322 116 54729   |
| R 2468 | RESISTOR, M. FILM | 82.5  | 1   | MR25 5322 116 54462   |
| R 2469 | RESISTOR, M. FILM | 18.7  | 1   | MR25 5322 116 50895   |

| POSNR  | DESCRIPTION       |       |     | ORDERING CODE       |
|--------|-------------------|-------|-----|---------------------|
| R 247  | RESISTOR, M. FILM | 6.81K | 1   | MR25 4822 116 51252 |
| R 2470 | RESISTOR, M. FILM | 1K    | 1   | MR25 4822 116 51235 |
| R 2471 | RESISTOR, CARBON  | 560   | 5   | CR16 4822 111 30309 |
| R 2472 | RESISTOR, CARBON  | 15    | 5   | CR16 5322 111 44153 |
| R 2473 | RESISTOR, M. FILM | 200K  | 0.5 | MR30 5322 116 51371 |
| R 2474 | RESISTOR, M. FILM | 51.1  | 1   | MR25 5322 116 54442 |
| R 2475 | RESISTOR, M. FILM | 1K    | 1   | MR25 4822 116 51235 |
| R 2476 | RESISTOR, M. FILM | 42.2  | 1   | MR25 5322 116 51052 |
| R 2477 | RESISTOR, M. FILM | 100K  | 1   | MR25 4822 116 51268 |
| R 2478 | RESISTOR, M. FILM | 42.2  | 1   | MR25 5322 116 51052 |
| R 2479 | RESISTOR, M. FILM | 920K  | 0.5 | MR30 5322 116 55218 |
| R 248  | RESISTOR, M. FILM | 6.81K | 1   | MR25 4822 116 51252 |
| R 2481 | POTM, TRIMMING    | 22K   | 20  | MR25 5322 101 54864 |
| R 2482 | RESISTOR, M. FILM | 86.6  | 1   | MR25 5322 116 54192 |
| R 2483 | RESISTOR, M. FILM | 5.11  | 1   | MR25 5322 116 54192 |
| R 2484 | RESISTOR, M. FILM | 18.7  | 1   | MR25 5322 116 50895 |
| R 2486 | RESISTOR, M. FILM | 402K  | 1   | MR25 5322 116 55283 |
| R 2487 | RESISTOR, M. FILM | 86.6  | 1   | MR25 5322 116 54464 |
| R 2488 | RESISTOR, M. FILM | 5.11  | 1   | MR25 5322 116 54192 |
| R 2489 | RESISTOR, M. FILM | 301   | 1   | MR25 5322 116 55366 |
| R 249  | RESISTOR, M. FILM | 6.81K | 1   | MR25 4822 116 51252 |
| R 2491 | RESISTOR, M. FILM | 301   | 1   | MR25 5322 116 55366 |
| R 2493 | RESISTOR, M. FILM | 306K  | 0.5 | MR25 5322 116 51369 |
| R 2494 | RESISTOR, M. FILM | 53.6K | 1   | MR25 5322 116 54674 |
| R 2496 | RESISTOR, M. FILM | 205   | 1   | MR25 5322 116 55365 |
| R 2497 | RESISTOR, M. FILM | 5.36K | 1   | MR25 5322 116 54597 |
| R 2498 | RESISTOR, M. FILM | 11K   | 1   | MR25 5322 116 54482 |
| R 2499 | RESISTOR, M. FILM | 133   | 1   | MR25 5322 116 54519 |
| R 2501 | RESISTOR, M. FILM | 402   | 1   | MR25 5322 116 54519 |
| R 2504 | RESISTOR, M. FILM | 100   | 1   | MR25 5322 116 55549 |
| R 2506 | RESISTOR, M. FILM | 100   | 1   | MR25 5322 116 55549 |
| R 2507 | RESISTOR, M. FILM | 5.36K | 1   | MR25 5322 116 54597 |
| R 2509 | RESISTOR, M. FILM | 715   | 1   | MR25 5322 116 50571 |
| R 251  | RESISTOR, M. FILM | 6.81K | 1   | MR25 4822 116 51252 |
| R 2511 | RESISTOR, M. FILM | 100K  | 1   | MR25 4822 116 51268 |
| R 2512 | RESISTOR, M. FILM | 590   | 1   | MR25 5322 116 50561 |
| R 2513 | RESISTOR, M. FILM | 8.25K | 1   | MR25 5322 116 54558 |
| R 2514 | RESISTOR, M. FILM | 14.7K | 1   | MR25 5322 116 54632 |
| R 2515 | RESISTOR, M. FILM | 51.1  | 1   | MR25 5322 116 54442 |
| R 2516 | RESISTOR, M. FILM | 51.1  | 1   | MR25 5322 116 54442 |
| R 2517 | RESISTOR, M. FILM | 100   | 1   | MR25 5322 116 55549 |
| R 2518 | RESISTOR, M. FILM | 1K    | 1   | MR25 4822 116 51235 |
| R 2519 | RESISTOR, M. FILM | 681   | 1   | MR25 4822 116 51233 |
| R 252  | RESISTOR, M. FILM | 6.81K | 1   | MR25 4822 116 51252 |
| R 2520 | RESISTOR, M. FILM | 100   | 1   | MR25 5322 116 55549 |
| R 2521 | RESISTOR, M. FILM | 88.7K | 0.5 | MR25 5322 116 55452 |
| R 2522 | RESISTOR, M. FILM | 7.15K | 1   | MR25 5322 116 54866 |
| R 2523 | RESISTOR, M. FILM | 100K  | 1   | MR25 5322 116 50452 |
| R 2524 | RESISTOR, M. FILM | 10    | 1   | MR25 5322 100 10112 |
| R 2526 | POTM, TRIMMING    | 1K    | 20  | 0.5W 5322 100 10112 |
| R 2527 | POTM, TRIMMING    | 1K    | 20  | 0.5W 5322 100 10112 |
| R 2528 | RESISTOR, M. FILM | 1.05K | 1   | MR25 5322 116 54552 |
| R 2529 | RESISTOR, M. FILM | 51.1  | 1   | MR25 5322 116 54442 |
| R 253  | RESISTOR, M. FILM | 6.81K | 1   | MR25 4822 116 51252 |
| R 2530 | RESISTOR, M. FILM | 100   | 1   | MR25 5322 116 55549 |
| R 2531 | RESISTOR, M. FILM | 15.4K | 1   | MR25 5322 116 55459 |
| R 2532 | RESISTOR, M. FILM | 1.69K | 1   | MR25 5322 116 54567 |
| R 2533 | RESISTOR, M. FILM | 1.05K | 1   | MR25 5322 116 54552 |
| R 2534 | POTM, TRIMMING    | 10K   | 20  | 0.5W 5322 100 10113 |
| R 2535 | RESISTOR, M. FILM | 100   | 1   | MR25 5322 116 55549 |
| R 2536 | POTM, TRIMMING    | 1K    | 20  | 0.5W 5322 100 10112 |
| R 2539 | RESISTOR, M. FILM | 301   | 1   | MR25 5322 116 55366 |
| R 254  | RESISTOR, M. FILM | 6.81K | 1   | MR25 4822 116 51252 |
| R 2540 | RESISTOR, M. FILM | 100   | 1   | MR25 5322 116 55549 |
| R 2541 | RESISTOR, M. FILM | 5.9K  | 1   | MR25 5322 116 50583 |

| POSNR  | DESCRIPTION       |       |     | ORDERING CODE         |
|--------|-------------------|-------|-----|-----------------------|
| R 2542 | RESISTOR, M. FILM | 1.4K  | 1   | MR25 5322 116 54562   |
| R 2543 | RESISTOR, M. FILM | 301   | 1   | MR25 5322 116 55366   |
| R 2545 | RESISTOR, M. FILM | 150   | 1   | MR25 5322 116 54486   |
| R 2546 | RESISTOR, M. FILM | 992K  | 0.5 | SPEC 5322 116 55153   |
| R 2547 | RESISTOR, M. FILM | 10    | 1   | MR25 5322 116 50452   |
| R 2548 | RESISTOR, M. FILM | 51.1  | 1   | MR25 5322 116 54442   |
| R 2549 | RESISTOR, M. FILM | 2.87K | 1   | MR25 5322 116 50414   |
| R 2551 | RESISTOR, M. FILM | 287   | 1   | MR25 5322 116 54506   |
| R 2552 | RESISTOR, M. FILM | 287   | 1   | MR25 5322 116 54506   |
| R 2553 | RESISTOR, M. FILM | 5.36K | 1   | MR25 5322 116 54597   |
| R 2554 | RESISTOR, M. FILM | 71.5K | 1   | MR25 5322 116 54685   |
| R 2556 | RESISTOR, M. FILM | 20.5K | 1   | MR25 5322 116 54643   |
| R 2557 | RESISTOR, M. FILM | 51.1  | 1   | MR25 5322 116 54442   |
| R 2558 | RESISTOR, M. FILM | 1K    | 1   | MR25 4822 116 51235   |
| R 2559 | RESISTOR, CARBON  | 10    | 5   | CR16 4822 111 30347   |
| R 256  | RESISTOR, M. FILM | 6.81K | 1   | MR25 4822 116 51252   |
| R 2560 | RESISTOR, M. FILM | 1.54K | 1   | MR25 5322 116 50585   |
| R 2561 | RESISTOR, M. FILM | 1K    | 1   | MR25 4822 116 51235   |
| R 2562 | RESISTOR, CARBON  | 100M  | 5   | 0.125W 5322 111 30376 |
| R 2564 | RESISTOR, M. FILM | 5.11  | 1   | MR25 5322 116 54192   |
| R 2565 | RESISTOR, M. FILM | 51.1  | 1   | MR25 5322 116 54442   |
| R 2566 | RESISTOR, M. FILM | 2.37K | 1   | MR25 5322 116 54576   |
| R 2568 | RESISTOR, CARBON  | 33    | 5   | CR16 4822 111 30067   |
| R 2569 | RESISTOR, M. FILM | 64.9  | 1   | MR25 5322 116 54453   |
| R 257  | RESISTOR, M. FILM | 6.81K | 1   | MR25 4822 116 51252   |
| R 2571 | RESISTOR, M. FILM | 115   | 1   | MR25 5322 116 54476   |
| R 2572 | RESISTOR, M. FILM | 124   | 1   | MR25 5322 116 54478   |
| R 2573 | RESISTOR, M. FILM | 261   | 1   | MR25 5322 116 54502   |
| R 2574 | RESISTOR, M. FILM | 9.09K | 1   | MR25 4822 116 51284   |
| R 2575 | RESISTOR, M. FILM | 100   | 1   | MR25 5322 116 55549   |
| R 2576 | POTM, TRIMMING    | 22K   | 20  | 0.5W 5322 101 14069   |
| R 2577 | RESISTOR, M. FILM | 100   | 1   | MR25 5322 116 55549   |
| R 2578 | RESISTOR, M. FILM | 8.06K | 0.5 | MR25 5322 116 55428   |
| R 2579 | RESISTOR, M. FILM | 2.26K | 1   | MR25 5322 116 50675   |
| R 258  | RESISTOR, M. FILM | 6.81K | 1   | MR25 4822 116 51252   |
| R 2580 | RESISTOR, M. FILM | 6.81  | 1   | MR25 5322 116 54013   |
| R 2581 | RESISTOR, M. FILM | 48.7K | 1   | MR25 5322 116 50442   |
| R 2582 | RESISTOR, M. FILM | 105   | 1   | MR25 5322 116 54472   |
| R 2583 | RESISTOR, M. FILM | 90.9  | 1   | MR25 5322 116 54466   |
| R 2584 | RESISTOR, M. FILM | 5.9K  | 1   | MR25 5322 116 50583   |
| R 2585 | RESISTOR, M. FILM | 51.1K | 1   | MR25 5322 116 50672   |
| R 2586 | RESISTOR, CARBON  | 22    | 5   | CR16 5322 111 30396   |
| R 2587 | RESISTOR, M. FILM | 249K  | 1   | MR25 5322 116 54734   |
| R 2588 | RESISTOR, M. FILM | 90.9  | 1   | MR25 5322 116 54466   |
| R 2589 | RESISTOR, M. FILM | 22.6  | 1   | MR25 5322 116 50491   |
| R 259  | RESISTOR, M. FILM | 6.81K | 1   | MR25 4822 116 51252   |
| R 2591 | RESISTOR, CARBON  | 27    | 5   | CR16 4822 111 30348   |
| R 2592 | RESISTOR, CARBON  | 33    | 5   | CR16 4822 111 30067   |
| R 2593 | RESISTOR, M. FILM | 806K  | 0.5 | MR25 5322 116 51369   |
| R 2594 | RESISTOR, M. FILM | 226K  | 1   | MR25 5322 116 54729   |
| R 2595 | RESISTOR, M. FILM | 1M    | 1   | MR25 5322 116 55535   |
| R 2596 | RESISTOR, M. FILM | 82.5  | 1   | MR25 5322 116 54462   |
| R 2597 | RESISTOR, M. FILM | 18.7  | 1   | MR25 5322 116 50895   |
| R 2598 | RESISTOR, CARBON  | 560   | 5   | CR16 4822 111 30309   |
| R 2599 | RESISTOR, CARBON  | 15    | 5   | CR16 5322 111 44153   |
| R 2600 | RESISTOR, M. FILM | 1K    | 1   | MR25 4822 116 51235   |
| R 2601 | RESISTOR, M. FILM | 200K  | 0.5 | MR30 5322 116 51371   |
| R 2602 | RESISTOR, M. FILM | 51.1  | 1   | MR25 5322 116 54442   |
| R 2603 | RESISTOR, M. FILM | 301   | 1   | MR25 5322 116 55366   |
| Q 2604 | RESISTOR, M. FILM | 42.2  | 1   | MR25 5322 116 51052   |
| R 2605 | RESISTOR, M. FILM | 1K    | 1   | MR25 4822 116 51235   |
| R 2606 | RESISTOR, M. FILM | 100K  | 1   | MR25 4822 116 51268   |
| R 2607 | RESISTOR, M. FILM | 301   | 1   | MR25 5322 116 55366   |
| R 2608 | RESISTOR, M. FILM | 42.2  | 1   | MR25 5322 116 51052   |
| R 2609 | RESISTOR, M. FILM | 920K  | 0.5 | MR30 5322 116 55218   |

| POSNR  | DESCRIPTION       |       |     | ORDERING CODE       |
|--------|-------------------|-------|-----|---------------------|
| R 261  | RESISTOR, M. FILM | 6.81K | 1   | MR25 4822 116 51252 |
| R 2611 | POTM, TRIMMING    | 22K   | 20  | 0.5W 5322 101 14069 |
| R 2612 | RESISTOR, M. FILM | 86.6  | 1   | MR25 5322 116 54464 |
| R 2613 | RESISTOR, M. FILM | 5.11  | 1   | MR25 5322 116 54192 |
| R 2614 | RESISTOR, M. FILM | 18.7  | 1   | MR25 5322 116 50895 |
| R 2619 | RESISTOR, M. FILM | 3802K | 1   | MR25 5322 116 54484 |
| R 2618 | RESISTOR, M. FILM | 5.11  | 1   | MR25 5322 116 54192 |
| R 2619 | RESISTOR, M. FILM | 806K  | 0.5 | MR25 5322 116 51369 |
| R 262  | RESISTOR, M. FILM | 6.81K | 1   | MR25 4822 116 51252 |
| R 2621 | RESISTOR, M. FILM | 53.6K | 1   | MR25 5322 116 54974 |
| R 2622 | RESISTOR, M. FILM | 205   | 1   | MR25 5322 116 54597 |
| R 2623 | RESISTOR, M. FILM | 5.36K | 1   | MR25 5322 116 54597 |
| R 2624 | RESISTOR, M. FILM | 11K   | 1   | MR25 5322 116 54023 |
| R 2626 | RESISTOR, M. FILM | 133   | 1   | MR25 5322 116 54482 |
| R 2627 | RESISTOR, M. FILM | 402   | 1   | MR25 5322 116 54519 |
| R 2628 | RESISTOR, M. FILM | 5.36K | 1   | MR25 5322 116 54597 |
| R 2529 | RESISTOR, M. FILM | 15.4K | 1   | MR25 5322 116 54559 |
| R 263  | RESISTOR, M. FILM | 6.81K | 1   | MR25 4822 116 51252 |
| R 2631 | RESISTOR, M. FILM | 681   | 1   | MR25 4822 116 51235 |
| R 2632 | RESISTOR, M. FILM | 100K  | 1   | MR25 4822 116 51268 |
| R 2633 | RESISTOR, M. FILM | 590   | 1   | MR25 5322 116 54558 |
| R 2634 | RESISTOR, M. FILM | 8.25K | 1   | MR25 5322 116 54558 |
| R 2639 | RESISTOR, M. FILM | 140K  | 1   | MR25 5322 116 54549 |
| R 2638 | RESISTOR, M. FILM | 88.7K | 0.5 | MR25 5322 116 55452 |
| R 2639 | RESISTOR, M. FILM | 7.15K | 1   | MR25 5322 116 54606 |
| R 264  | RESISTOR, M. FILM | 6.81K | 1   | MR25 4822 116 51252 |
| R 2641 | RESISTOR, M. FILM | 100K  | 1   | MR25 4822 116 51268 |
| R 2542 | POTM, TRIMMING    | 1K    | 20  | 0.5W 5322 100 10112 |
| R 2643 | POTM, TRIMMING    | 1K    | 20  | 0.5W 5322 100 10112 |
| R 2644 | RESISTOR, M. FILM | 1.05K | 1   | MR25 5322 116 54552 |
| R 2646 | RESISTOR, M. FILM | 51.1  | 1   | MR25 5322 116 54442 |
| R 2647 | RESISTOR, M. FILM | 15.4K | 1   | MR25 5322 116 54559 |
| R 2548 | RESISTOR, M. FILM | 1.69K | 1   | MR25 5322 116 54567 |
| R 2649 | RESISTOR, M. FILM | 7.15K | 1   | MR25 5322 116 54606 |
| R 2651 | RESISTOR, M. FILM | 100K  | 1   | MR25 4822 116 51268 |
| R 2652 | RESISTOR, M. FILM | 1.87K | 1   | MR25 5322 116 50728 |
| R 2653 | RESISTOR, M. FILM | 33.2K | 1   | MR25 4822 116 51259 |
| R 2654 | RESISTOR, M. FILM | 1.05K | 1   | MR25 5322 116 54552 |
| R 2659 | RESISTOR, M. FILM | 30.1  | 1   | MR25 5322 116 50904 |
| R 2659 | POTM, TRIMMING    | 10K   | 20  | 0.5W 5322 100 10113 |
| R 2658 | POTM, TRIMMING    | 1K    | 20  | 0.5W 5322 100 10112 |
| R 2661 | POTM, TRIMMING    | 6.81K | 20  | 0.5W 4822 116 51252 |
| R 2661 | POTM, TRIMMING    | 22K   | 20  | 0.5W 5322 101 14069 |
| R 2662 | RESISTOR, M. FILM | 30.1  | 1   | MR25 5322 116 50904 |
| R 2663 | RESISTOR, M. FILM | 33.2K | 1   | MR25 4822 116 51259 |
| R 2664 | RESISTOR, M. FILM | 226K  | 1   | MR25 5322 116 54729 |
| R 2665 | RESISTOR, M. FILM | 1K    | 1   | MR25 4822 116 51235 |
| R 2666 | RESISTOR, M. FILM | 226K  | 1   | MR25 5322 116 54729 |
| R 2667 | RESISTOR, M. FILM | 226K  | 1   | MR25 5322 116 54729 |
| R 2668 | RESISTOR, M. FILM | 226K  | 1   | MR25 5322 116 54729 |
| R 2669 | RESISTOR, M. FILM | 226K  | 1   | MR25 5322 116 54729 |
| R 267  | RESISTOR, M. FILM | 6.81K | 1   | MR25 4822 116 51252 |
| R 2670 | RESISTOR, M. FILM | 511   | 1   | MR25 4822 116 51282 |
| R 2671 | RESISTOR, M. FILM | 6.81K | 1   | MR25 4822 116 51252 |
| R 2672 | RESISTOR, M. FILM | 6.81K | 1   | MR25 4822 116 51252 |
| R 2673 | RESISTOR, M. FILM | 6.81K | 1   | MR25 4822 116 51252 |
| R 2674 | RESISTOR, M. FILM | 6.81K | 1   | MR25 4822 116 51252 |
| R 2675 | RESISTOR, M. FILM | 1.62K | 1   | MR25 5322 116 55359 |
| R 2676 | RESISTOR, M. FILM | 7.5K  | 1   | MR25 5322 116 54608 |
| R 2677 | RESISTOR, M. FILM | 7.5K  | 1   | MR25 5322 116 54608 |
| R 2678 | RESISTOR, M. FILM | 3.83K | 1   | MR25 5322 116 54589 |
| R 2679 | RESISTOR, M. FILM | 121   | 1   | MR25 5322 116 54426 |
| R 268  | RESISTOR, M. FILM | 6.81K | 1   | MR25 4822 116 51252 |

| POSNR   | DESCRIPTION             | ORDERING CODE            |
|---------|-------------------------|--------------------------|
| R 2680  | RESISTOR, M. FILM 1.62K | 1 MR25 5322 116 55359    |
| R 2681  | RESISTOR, M. FILM 1.15K | 1 MR25 5322 116 50415    |
| R 2682  | RESISTOR, M. FILM 10K   | 1 MR25 4822 116 51253    |
| R 2683  | RESISTOR, M. FILM 10K   | 1 MR25 4822 116 51253    |
| R 2684  | RESISTOR, M. FILM 226K  | 1 MR25 5322 116 54729    |
| R 2686  | RESISTOR, M. FILM 10K   | 1 MR25 4822 116 51253    |
| R 2687  | RESISTOR, M. FILM 10K   | 1 MR25 4822 116 51253    |
| R 2688  | RESISTOR, M. FILM 1K    | 1 MR25 4822 116 51235    |
| R 269   | RESISTOR, M. FILM 6.81K | 1 MR25 4822 116 51252    |
| R 2690  | RESISTOR, M. FILM 1K    | 1 MR25 4822 116 51235    |
| R 2701  | RESISTOR, M. FILM 909K  | 1 MR25 5322 116 55533    |
| R 2702  | RESISTOR, M. FILM 110K  | 1 MR25 5322 116 54701    |
| R 2703  | RESISTOR, M. FILM 681K  | 1 MR25 5322 116 55284    |
| R 2704  | RESISTOR, CARBON 100M   | 5 0, 125W 5322 111 30376 |
| R 2706  | RESISTOR, M. FILM 866   | 1 MR25 5322 116 54543    |
| R 2707  | RESISTOR, SAFETY 7.37K  | 1 MR25 5322 116 50458    |
| R 2708  | RESISTOR, M. FILM 5.11K | 1 MR25 5322 116 54595    |
| R 2709  | RESISTOR, M. FILM 5.11  | 1 MR25 5322 116 54192    |
| R 271   | RESISTOR, M. FILM 2.26K | 1 MR25 5322 116 50675    |
| R 2711  | RESISTOR, M. FILM 10    | 1 MR25 5322 116 50452    |
| R 2712  | RESISTOR, M. FILM 154K  | 1 MR25 5322 116 54714    |
| R 2713  | RESISTOR, M. FILM 215K  | 1 MR25 5322 116 54728    |
| R 2714  | RESISTOR, M. FILM 100   | 1 MR25 5322 116 55549    |
| R 2716  | RESISTOR, M. FILM 10K   | 1 MR25 4822 116 51253    |
| R 2717  | RESISTOR, M. FILM 10K   | 1 MR25 4822 116 51253    |
| R 27111 | RESISTOR, M. FILM 5.11  | 1 MR25 5322 116 54192    |
| R 2719  | RESISTOR, M. FILM 10    | 1 MR25 5322 116 50452    |
| R 272   | RESISTOR, M. FILM 6.81K | 1 MR25 4822 116 51252    |
| R 2721  | RESISTOR, M. FILM 6.81K | 1 MR25 4822 116 51252    |
| R 2722  | RESISTOR, M. FILM 4.22K | 1 MR25 5322 116 50729    |
| R 2723  | RESISTOR, M. FILM 1.4K  | 1 MR25 5322 116 51662    |
| R 2724  | RESISTOR, M. FILM 10K   | 1 MR25 4822 116 51253    |
| R 2726  | RESISTOR, M. FILM 10K   | 1 MR25 4822 116 51253    |
| R 2727  | RESISTOR, M. FILM 1K    | 1 MR25 4822 116 51235    |
| R 2728  | RESISTOR, M. FILM 10K   | 1 MR25 4822 116 51253    |
| R 2729  | RESISTOR, M. FILM 110K  | 1 MR25 5322 116 54701    |
| R 273   | RESISTOR, M. FILM 2.26K | 1 MR25 5322 116 50675    |
| R 2731  | RESISTOR, M. FILM 40.2K | 1 MR25 5322 116 54665    |
| R 2732  | RESISTOR, M. FILM 10K   | 1 MR25 4822 116 51253    |
| R 2733  | RESISTOR, M. FILM 237K  | 1 MR25 5322 116 54732    |
| R 2734  | RESISTOR, M. FILM 187K  | 1 MR25 5322 116 54723    |
| R 2736  | RESISTOR, M. FILM 2.49K | 1 MR25 5322 116 50581    |
| R 2737  | RESISTOR, M. FILM 1.69K | 1 MR25 5322 116 54567    |
| R 2738  | RESISTOR, M. FILM 22.6  | 1 MR25 5322 116 50491    |
| R 2739  | RESISTOR, M. FILM 205   | 1 MR25 5322 116 55365    |
| R 274   | RESISTOR, M. FILM 6.81K | 1 MR25 4822 116 51252    |
| R 2741  | RESISTOR, M. FILM 681K  | 1 MR25 5322 116 55284    |
| R 2742  | RESISTOR, M. FILM 6.81K | 1 MR25 4822 116 51252    |
| R 2743  | RESISTOR, M. FILM 10K   | 1 MR25 4822 116 51253    |
| R 2744  | RESISTOR, M. FILM 10K   | 1 MR25 4822 116 51253    |
| R 2746  | RESISTOR, M. FILM 10K   | 1 MR25 4822 116 51253    |
| R 2747  | RESISTOR, M. FILM 51.1  | 1 MR25 5322 116 54442    |
| R 2748  | RESISTOR, M. FILM 590   | 1 MR25 5322 116 50561    |
| R 2749  | RESISTOR, M. FILM 10K   | 1 MR25 4822 116 51253    |
| R 2751  | RESISTOR, M. FILM 715   | 1 MR25 5322 116 50571    |
| R 2752  | RESISTOR, M. FILM 82.5K | 1 MR25 5322 116 55374    |
| R 2753  | POTM, TRIMMING 220      | 20 0, 5W 5322 101 14009  |
| R 2754  | RESISTOR, M. FILM 2.37K | 1 MR25 5322 116 54576    |
| R 2756  | RESISTOR, M. FILM 3.48K | 1 MR25 5322 116 55367    |
| R 2757  | RESISTOR, M. FILM 82.5K | 1 MR25 5322 116 55374    |
| R 2758  | RESISTOR, M. FILM 215K  | 1 MR25 5322 116 54728    |
| R 2759  | RESISTOR, M. FILM 442   | 1 MR25 5322 116 50592    |
| R 276   | RESISTOR, M. FILM 2.26K | 1 MR25 5322 116 50675    |
| R 2761  | RESISTOR, M. FILM 75K   | 1 MR25 4822 116 51267    |
| R 2763  | RESISTOR, M. FILM 205   | 1 MR25 5322 116 55365    |

| POSNR  | DESCRIPTION             | ORDERING CODE           |
|--------|-------------------------|-------------------------|
| R 2764 | RESISTOR, M. FILM 681K  | 1 MR25 5322 116 55284   |
| R 2766 | RESISTOR, M. FILM 6.81K | 1 MR25 4822 116 51252   |
| R 2767 | RESISTOR, M. FILM 100K  | 1 MR25 4822 116 51268   |
| R 2768 | RESISTOR, M. FILM 1K    | 1 MR25 4822 116 51235   |
| R 2769 | RESISTOR, M. FILM 590   | 1 MR25 5322 116 50561   |
| R 277  | RESISTOR, M. FILM 6.81K | 1 MR25 4822 116 51252   |
| R 2771 | RESISTOR, M. FILM 10K   | 1 MR25 4822 116 51253   |
| R 2772 | RESISTOR, M. FILM 6.81K | 1 MR25 4822 116 51252   |
| R 2773 | RESISTOR, M. FILM 22.6  | 1 MR25 5322 116 50491   |
| R 2774 | RESISTOR, M. FILM 100   | 1 MR25 5322 116 55549   |
| R 2775 | RESISTOR, M. FILM 2,74K | 1 MR25 5322 116 50636   |
| R 2777 | RESISTOR, M. FILM 3,83K | 1 MR25 5322 116 54589   |
| R 2778 | RESISTOR, M. FILM 140   | 1 MR25 5322 116 55568   |
| R 2779 | RESISTOR, M. FILM 5,11  | 1 MR25 5322 116 54192   |
| R 278  | RESISTOR, M. FILM 2,26K | 1 MR25 5322 116 50675   |
| R 2781 | RESISTOR, M. FILM 10,5K | 1 MR25 5322 116 50731   |
| R 2782 | RESISTOR, M. FILM 5.11  | 1 MR25 5322 116 54192   |
| R 2783 | RESISTOR, M. FILM 100K  | 1 MR25 4822 116 51268   |
| R 2784 | RESISTOR, M. FILM 100   | 1 MR25 5322 116 55549   |
| R 2786 | RESISTOR, M. FILM 10K   | 1 MR25 4822 116 51253   |
| R 2787 | RESISTOR, M. FILM 1K    | 1 MR25 4822 116 51235   |
| R 2788 | RESISTOR, M. FILM 30,1K | 1 MR25 5322 116 54655   |
| R 2789 | RESISTOR, M. FILM 10K   | 1 MR25 4822 116 51253   |
| R 279  | RESISTOR, M. FILM 6,81K | 1 MR25 4822 116 51252   |
| R 2791 | RESISTOR, M. FILM 30,1K | 1 MR25 5322 116 54655   |
| R 2792 | RESISTOR, M. FILM 10K   | 1 MR25 4822 116 54089   |
| R 2793 | RESISTOR, M. FILM 3,32K | 1 MR25 5322 116 50578   |
| R 2794 | RESISTOR, M. FILM 78,7  | 1 MR25 5322 116 50506   |
| R 2795 | RESISTOR, M. FILM 154   | 1 MR25 5322 116 50506   |
| R 2796 | RESISTOR, M. FILM 1K    | 1 MR25 4822 116 51235   |
| R 2797 | RESISTOR, M. FILM 3,32K | 1 MR25 5322 116 54005   |
| R 2798 | RESISTOR, M. FILM 3,01K | 1 MR25 4822 116 51246   |
| R 2799 | RESISTOR, M. FILM 1,54K | 1 MR25 5322 116 50586   |
| R 2801 | RESISTOR, M. FILM 10K   | 1 MR25 4822 116 51253   |
| R 2802 | RESISTOR, M. FILM 10K   | 1 MR25 4822 116 51253   |
| R 2803 | RESISTOR, M. FILM 10K   | 1 MR25 4822 116 51253   |
| R 2804 | RESISTOR, M. FILM 10K   | 1 MR25 4822 116 51253   |
| R 2806 | RESISTOR, M. FILM 10K   | 1 MR25 4822 116 51253   |
| R 2807 | RESISTOR, M. FILM 10K   | 1 MR25 4822 116 51253   |
| R 2808 | RESISTOR, M. FILM 10K   | 1 MR25 4822 116 51253   |
| R 2809 | RESISTOR, M. FILM 10K   | 1 MR25 4822 116 51253   |
| R 281  | RESISTOR, M. FILM 2,26K | 1 MR25 5322 116 50635   |
| R 2811 | RESISTOR, M. FILM 115   | 1 MR25 5322 116 54476   |
| R 2812 | RESISTOR, M. FILM 1K    | 1 MR25 4822 116 51235   |
| R 2813 | RESISTOR, M. FILM 1K    | 1 MR25 4822 116 51235   |
| R 2811 | RESISTOR, M. FILM 590   | 1 MR25 5322 116 50561   |
| R 2816 | RESISTOR, M. FILM 10K   | 1 MR25 4822 116 51253   |
| R 2817 | RESISTOR, M. FILM 115   | 1 MR25 5322 116 54476   |
| R 2818 | RESISTOR, M. FILM 5,11K | 1 MR25 5322 116 54595   |
| R 2819 | POTM, TRIMMING 220      | 20 0, 5W 5322 101 14009 |
| R 282  | RESISTOR, M. FILM 6.81K | 1 MR25 4822 116 51252   |
| R 2820 | RESISTOR, M. FILM 787   | 1 MR25 5322 116 54538   |
| R 2821 | RESISTOR, M. FILM 22.6  | 1 MR25 5322 116 50491   |
| R 2822 | RESISTOR, M. FILM 383   | 1 MR25 5322 116 55368   |
| R 2823 | RESISTOR, M. FILM 511   | 1 MR25 4822 116 51282   |
| R 2824 | RESISTOR, M. FILM 1,54K | 1 MR25 5322 116 50586   |
| R 2825 | RESISTOR, M. FILM 51.1  | 1 MR25 5322 116 54442   |
| R 2826 | RESISTOR, M. FILM 22.6  | 1 MR25 5322 116 50491   |
| R 2827 | RESISTOR, M. FILM 2,49K | 1 MR25 5322 116 50581   |
| R 2828 | RESISTOR, M. FILM 1,27K | 1 MR25 5322 114 50555   |
| R 2829 | RESISTOR, M. FILM 590   | 1 MR25 5322 116 50561   |
| R 283  | RESISTOR, M. FILM 2,26K | 1 MR25 5322 116 50675   |
| R 2830 | RESISTOR, M. FILM 51,1  | 1 MR25 5322 116 54442   |
| R 2831 | RESISTOR, M. FILM 1,15K | 1 MR25 5322 116 50415   |
| R 2832 | RESISTOR, M. FILM 22.6  | 1 MR25 5322 116 50491   |

| POSNR  | DESCRIPTION             | ORDERING CODE          |
|--------|-------------------------|------------------------|
| R 2833 | RESISTOR, M. FILM 511   | 1 MR25 4822 116 51282  |
| R 2834 | RESISTOR, M. FILM 22.6  | 1 MR25 5322 116 50491  |
| R 2835 | RESISTOR, M. FILM 348   | 1 MR25 5322 116 54515  |
| R 2836 | RESISTOR, M. FILM 1.62K | 1 MR25 5322 116 55359  |
| R 2837 | RESISTOR, M. FILM 4.22K | 1 MR25 5322 116 50729  |
| R 2838 | RESISTOR, M. FILM 1.62K | 1 MR25 5322 116 55359  |
| R 2839 | RESISTOR, M. FILM 22.6  | 1 MR25 5322 116 50491  |
| R 284  | RESISTOR, M. FILM 6.81K | 1 MR25 4822 116 51252  |
| R 2840 | RESISTOR, M. FILM 51.1  | 1 MR25 5322 116 54442  |
| R 2841 | RESISTOR, M. FILM 22.6  | 1 MR25 5322 116 50491  |
| R 2842 | RESISTOR, M. FILM 1.62K | 1 MR25 5322 116 55359  |
| R 2843 | RESISTOR, M. FILM 4.22K | 1 MR25 5322 116 50729  |
| R 2844 | RESISTOR, M. FILM 1.62K | 1 MR25 5322 116 55359  |
| R 2845 | RESISTOR, M. FILM 348   | 1 MR25 5322 116 54515  |
| R 2846 | RESISTOR, M. FILM 22.6  | 1 MR25 5322 116 50491  |
| R 2847 | RESISTOR, M. FILM 10K   | 1 MR25 4822 116 51253  |
| R 2848 | RESISTOR, M. FILM 10K   | 1 MR25 4822 116 51253  |
| R 2849 | RESISTOR, M. FILM 10K   | 1 MR25 4822 116 51253  |
| R 2850 | RESISTOR, M. FILM 348   | 1 MR25 5322 116 54515  |
| R 2851 | RESISTOR, M. FILM 511   | 1 MR25 4822 116 51282  |
| R 2852 | RESISTOR, M. FILM 590   | 1 MR25 5322 116 50561  |
| R 2853 | RESISTOR, M. FILM 4.42K | 1 MR25 5322 116 50556  |
| R 2854 | RESISTOR, M. FILM 1.87K | 1 MR25 5322 116 50728  |
| R 2855 | RESISTOR, M. FILM 51.1  | 1 MR25 5322 116 54442  |
| R 2156 | RESISTOR, M. FILM 10K   | 1 MR25 4822 116 51253  |
| R 2857 | POTM, TRIMMING 470      | 20 0.5W 5322 101 14047 |
| R 2858 | RESISTOR, M. FILM 4.64K | 1 MR25 5322 116 50484  |
| R 2859 | POTM, TRIMMING 1K       | 20 0.5W 5322 100 10112 |
| R 286  | RESISTOR, M. FILM 2.26K | 1 MR25 5322 116 50675  |
| R 2860 | RESISTOR, M. FILM 348   | 1 MR25 5322 116 54515  |
| R 2861 | POTM, TRIMMING 1K       | 20 0.5W 5322 100 10112 |
| R 2862 | RESISTOR, M. FILM 8.25K | 1 MR25 5322 116 54558  |
| R 2863 | RESISTOR, M. FILM 40.2  | 1 MR25 5322 116 50926  |
| R 2864 | RESISTOR, M. FILM 1K    | 1 MR25 4822 116 51235  |
| R 2866 | RESISTOR, M. FILM 40.2  | 1 MR25 5322 116 50925  |
| R 2867 | POTM, TRIMMING 10K      | 20 0.5W 5322 100 10113 |
| R 287  | RESISTOR, M. FILM 2.26K | 1 MR25 5322 116 50675  |
| R 2901 | RESISTOR, M. FILM 1     | 1 MR25 4822 116 51179  |
| R 2902 | RESISTOR, M. FILM 1     | 1 MR25 4822 116 51179  |
| R 2903 | RESISTOR, M. FILM 22.6  | 1 MR25 5322 116 50491  |
| R 2904 | RESISTOR, M. FILM 2.15  | 1 MR25 5322 116 55536  |
| R 2907 | RESISTOR, M. FILM 5.11  | 1 MR25 5322 116 54192  |
| R 2908 | RESISTOR, M. FILM 5.11  | 1 MR25 5322 116 54192  |
| R 2909 | RESISTOR, M. FILM 1M    | 1 MR25 5322 116 55535  |
| R 291  | RESISTOR, M. FILM 6.81K | 1 MR25 4822 116 51252  |
| R 2910 | POTM, TRIMMING 2.2K     | 20 0.5W 5322 101 14008 |
| R 2911 | POTM, TRIMMING 100K     | 20 0.5W 5322 101 14071 |
| R 2912 | RESISTOR, M. FILM 22.6K | 1 MR25 5322 116 50481  |
| R 2913 | RESISTOR, M. FILM 6.49K | 1 MR25 5322 116 54603  |
| R 2914 | RESISTOR, M. FILM 105K  | 1 MR25 5322 116 54698  |
| R 2916 | RESISTOR, M. FILM 10K   | 1 MR25 4822 116 51253  |
| R 2917 | RESISTOR, M. FILM 121K  | 1 MR25 5322 116 54704  |
| R 2918 | RESISTOR, M. FILM 681   | 1 MR25 4822 116 51233  |
| R 2919 | RESISTOR, M. FILM 2.49K | 1 MR25 5322 116 50581  |
| R 292  | RESISTOR, M. FILM 2.26K | 1 MR25 5322 116 50675  |
| R 2921 | RESISTOR, M. FILM 5.11K | 1 MR25 5322 116 54595  |
| R 2922 | RESISTOR, M. FILM 5.11K | 1 MR25 5322 116 54595  |
| R 2923 | RESISTOR, M. FILM 10K   | 1 MR25 4822 116 51253  |
| R 2924 | RESISTOR, M. FILM 6.81K | 1 MR25 4822 116 51252  |
| R 2925 | RESISTOR, M. FILM 205   | 1 MR25 5322 116 55365  |
| R 2926 | RESISTOR, M. FILM 1K    | 1 MR25 4822 116 51235  |
| R 2927 | RESISTOR, M. FILM 1K    | 1 MR25 4822 116 51235  |
| R 2928 | RESISTOR, M. FILM 1K    | 1 MR25 4822 116 51235  |
| R 2929 | RESISTOR, M. FILM 1K    | 1 MR25 4822 116 51235  |
| R 293  | RESISTOR, M. FILM 2.26K | 1 MR25 5322 116 50675  |

| POSNR  | DESCRIPTION             | ORDERING CODE          |
|--------|-------------------------|------------------------|
| R 2930 | RESISTOR, M. FILM 205   | 1 MR25 5322 116 55365  |
| R 2931 | RESISTOR, M. FILM 1.21K | 1 MR25 5322 116 54557  |
| R 2932 | RESISTOR, M. FILM 27.4K | 1 MR25 5322 116 50559  |
| R 2933 | RESISTOR, M. FILM 2.05K | 1 MR25 5322 116 50664  |
| R 2934 | RESISTOR, M. FILM 511   | 1 MR25 4822 116 51282  |
| R 2935 | RESISTOR, M. FILM 215   | 1 MR25 5322 116 55274  |
| R 2936 | RESISTOR, M. FILM 205   | 1 MR25 5322 116 55365  |
| R 2937 | RESISTOR, M. FILM 10    | 1 MR25 5322 116 50452  |
| R 2938 | RESISTOR, M. FILM 2.05K | 1 MR25 5322 116 50664  |
| R 2939 | RESISTOR, M. FILM 30.1  | 1 MR25 5322 116 50904  |
| R 294  | RESISTOR, M. FILM 82.5K | 1 MR25 5322 116 55374  |
| R 2940 | RESISTOR, M. FILM 100   | 1 MR25 5322 116 55549  |
| R 2941 | RESISTOR, M. FILM 825   | 1 MR25 5322 116 54541  |
| R 2942 | RESISTOR, M. FILM 2.15K | 1 MR25 5322 116 50767  |
| R 2943 | RESISTOR, M. FILM 511   | 1 MR25 4822 116 51282  |
| R 2944 | RESISTOR, M. FILM 5.11K | 1 MR25 5322 116 54595  |
| R 2945 | RESISTOR, M. FILM 10    | 1 MR25 5322 116 50452  |
| R 2946 | RESISTOR, M. FILM 5.11K | 1 MR25 5322 116 54595  |
| R 2947 | RESISTOR, M. FILM 4.64K | 1 MR25 5322 116 50484  |
| R 2948 | RESISTOR, M. FILM 205   | 1 MR25 5322 116 55365  |
| R 2949 | RESISTOR, M. FILM 1.21K | 1 MR25 5322 116 54557  |
| R 2950 | RESISTOR, M. FILM 16.2  | 1 MR25 5322 116 54431  |
| R 2951 | RESISTOR, M. FILM 205   | 1 MR25 5322 116 55365  |
| R 2952 | RESISTOR, M. FILM 100   | 1 MR25 5322 116 55549  |
| R 2953 | RESISTOR, M. FILM 3.01K | 1 MR25 4822 116 51246  |
| R 2954 | RESISTOR, M. FILM 10K   | 1 MR25 4822 116 51253  |
| R 2955 | RESISTOR, M. FILM 249   | 1 MR25 5322 116 54499  |
| R 2956 | RESISTOR, M. FILM 30.1K | 1 MR25 5322 116 54655  |
| R 2957 | RESISTOR, M. FILM 100   | 1 MR25 5322 116 55549  |
| R 2958 | POTM, TRIMMING 10K      | 20 0.5W 5322 100 10113 |
| R 2959 | RESISTOR, M. FILM 1K    | 1 MR25 4822 116 51235  |
| R 296  | RESISTOR, M. FILM 82.5K | 1 MR25 4822 116 55374  |
| R 2960 | RESISTOR, M. FILM 681   | 1 MR25 4822 116 51235  |
| R 2961 | RESISTOR, M. FILM 1K    | 1 MR25 4822 116 51235  |
| R 2962 | RESISTOR, M. FILM 205   | 1 MR25 5322 116 55365  |
| R 2963 | RESISTOR, M. FILM 205   | 1 MR25 5322 116 55365  |
| R 2964 | RESISTOR, M. FILM 1K    | 1 MR25 4822 116 51235  |
| R 2965 | RESISTOR, M. FILM 287   | 1 MR25 5322 116 54506  |
| R 2966 | RESISTOR, M. FILM 1K    | 1 MR25 4822 116 51235  |
| R 2967 | RESISTOR, M. FILM 2.15K | 1 MR25 5322 116 50767  |
| R 2368 | RESISTOR, M. FILM 511   | 1 MR25 4822 116 51282  |
| R 2969 | RESISTOR, M. FILM 1K    | 1 MR25 4822 116 51235  |
| R 3    | RESISTOR, M. FILM 10K   | 20 0.1W 5322 101 24184 |
| R 3001 | RESISTOR, M. FILM 249   | 1 MR25 5322 116 54499  |
| R 3002 | RESISTOR, M. FILM 590   | 1 MR25 5322 116 50561  |
| R 3003 | RESISTOR, M. FILM 33.2  | 1 MR25 5322 116 50527  |
| R 3004 | RESISTOR, M. FILM 100   | 1 MR25 5322 116 55549  |
| R 3005 | RESISTOR, M. FILM 274   | 1 MR25 5322 116 54504  |
| R 3006 | RESISTOR, M. FILM 100   | 1 MR25 5322 116 55549  |
| R 3007 | RESISTOR, M. FILM 24.9  | 1 MR25 5322 116 50903  |
| R 3008 | RESISTOR, M. FILM 750   | 1 MR25 4822 116 51234  |
| R 3009 | POTM, TRIMMING 2.2K     | 20 0.5W 5322 101 14008 |
| R 3011 | RESISTOR, M. FILM 261   | 1 MR25 5322 116 54502  |
| R 3012 | RESISTOR, M. FILM 274   | 1 MR25 5322 116 54504  |
| R 3013 | RESISTOR, M. FILM 2.37K | 1 MR25 5322 116 50414  |
| R 3014 | RESISTOR, M. FILM 2.37K | 1 MR25 5322 116 50414  |
| R 3016 | RESISTOR, M. FILM 2.26K | 1 MR25 5322 116 50675  |
| R 3017 | RESISTOR, M. FILM 249   | 1 MR25 5322 116 54499  |
| R 3018 | RESISTOR, M. FILM 3.83K | 1 MR25 5322 116 59589  |
| R 3019 | RESISTOR, M. FILM 75    | 1 MR25 5322 116 54459  |
| R 3020 | RESISTOR, M. FILM 90.9  | 1 MR25 5322 116 54466  |
| R 3021 | RESISTOR, M. FILM 178   | 1 MR25 5322 116 54492  |
| R 3022 | RESISTOR, M. FILM 178   | 1 MR25 5322 116 54492  |
| R 3023 | RESISTOR, M. FILM 100K  | 1 MR25 4822 116 51268  |
| R 3024 | RESISTOR, M. FILM 6.81K | 1 MR25 4822 116 51252  |

| POSNR  | DESCRIPTION       |       |    | ORDERING CODE       |
|--------|-------------------|-------|----|---------------------|
| R 3026 | RESISTOR, M. FILM | 11K   | 1  | MR25 5322 116 54623 |
| R 3027 | RESISTOR, M. FILM | 75    | 1  | MR25 5322 116 54459 |
| R 3028 | RESISTOR, M. FILM | 2,26K | 1  | MR25 5322 116 50675 |
| R 3029 | POTM, TRIMMING    | 2,2K  | 20 | 0.5W 5322 101 14008 |
| R 3030 | RESISTOR, M. FILM | 3,32K | 1  | MR25 5322 116 54005 |
| R 3031 | RESISTOR, M. FILM | 90,9  | 1  | MR25 5322 116 54466 |
| R 3032 | RESISTOR, M. FILM | 30,1  | 1  | MR25 5322 116 50904 |
| R 3033 | RESISTOR, M. FILM | 30,1  | 1  | MR25 5322 116 50904 |
| R 3034 | RESISTOR, M. FILM | 33,2  | 1  | MR25 5322 116 50527 |
| R 3036 | RESISTOR, M. FILM | 619   | 1  | MR25 4822 116 51232 |
| R 3037 | RESISTOR, M. FILM | 75    | 1  | MR25 5322 116 54459 |
| R 3038 | RESISTOR, M. FILM | 215   | 1  | MR25 5322 116 55274 |
| R 3039 | POTM, TRIMMING    | 10K   | 20 | 0.5W 5322 100 10113 |
| R 3040 | RESISTOR, M. FILM | 36,5  | 1  | MR25 5322 116 50409 |
| R 3041 | RESISTOR, M. FILM | 100   | 1  | MR25 5322 116 55549 |
| R 3043 | RESISTOR, M. FILM | 1,96K | 1  | MR25 5322 116 54571 |
| R 3044 | RESISTOR, M. FILM | 100   | 1  | MR25 5322 116 55549 |
| R 3045 | RESISTOR, M. FILM | 36,5  | 1  | MR25 5322 116 50409 |
| R 3046 | RESISTOR, M. FILM | 619   | 1  | MR25 4822 116 51232 |
| R 3047 | RESISTOR, M. FILM | 33,2  | 1  | MR25 5322 116 50527 |
| R 3048 | RESISTOR, M. FILM | 187   | 1  | MR25 5322 116 54494 |
| R 3049 | RESISTOR, M. FILM | 187   | 1  | MR25 5322 116 54494 |
| R 3050 | RESISTOR, M. FILM | 127   | 1  | MR25 5322 116 54479 |
| R 3051 | RESISTOR, M. FILM | 196   | 1  | MR25 5322 116 55273 |
| R 3052 | RESISTOR, M. FILM | 10K   | 1  | MR25 4822 116 51253 |
| R 3053 | RESISTOR, M. FILM | 402   | 1  | MR25 5322 116 54519 |
| R 3054 | RESISTOR, M. FILM | 4,22K | 1  | MR25 5322 116 50729 |
| R 3055 | RESISTOR, M. FILM | 127   | 1  | MR25 5322 116 54479 |
| R 3056 | POTM, TRIMMING    | 220   | 20 | 0,5W 5322 101 14009 |
| R 3057 | POTM, TRIMMING    | 1K    | 20 | 0,5W 5322 100 10112 |
| R 3058 | RESISTOR, M. FILM | 100   | 1  | MR25 5322 116 55549 |
| R 3059 | RESISTOR, M. FILM | 2,15K | 1  | MR25 5322 116 50767 |
| R 3061 | RESISTOR, M. FILM | 1,78K | 1  | MR25 5322 116 50515 |
| R 3063 | RESISTOR, M. FILM | 2,87K | 1  | MR25 5322 116 50414 |
| R 3064 | RESISTOR, M. FILM | 2,87K | 1  | MR25 5322 116 50414 |
| R 3066 | RESISTOR, M. FILM | 33,2  | 1  | MR25 5322 116 50527 |
| R 3067 | RESISTOR, M. FILM | 2,87K | 1  | MR25 5322 116 50414 |
| R 3068 | RESISTOR, M. FILM | 75    | 1  | MR25 5322 116 54459 |
| R 3069 | RESISTOR, M. FILM | 2,87K | 1  | MR25 5322 116 50414 |
| R 3071 | RESISTOR, M. FILM | 12,7K | 1  | MR25 5322 116 50443 |
| R 3072 | RESISTOR, M. FILM | 7,5K  | 1  | MR25 5322 116 54608 |
| R 3201 | POTM, TRIMMING    | 10K   | 20 | 0.5W 5322 101 14066 |
| R 3202 | POTM, TRIMMING    | 10K   | 20 | 0.5W 5322 101 14066 |
| R 3203 | POTM, TRIMMING    | 10K   | 20 | 0.5W 5322 101 14066 |
| R 3204 | POTM, TRIMMING    | 10K   | 20 | 0.5W 5322 101 14066 |
| R 3206 | POTM, TRIMMING    | 22K   | 20 | 0.5W 5322 100 10118 |
| R 3207 | POTM, TRIMMING    | 22K   | 20 | 0.5W 5322 100 10118 |
| R 3208 | POTM, TRIMMING    | 22K   | 20 | 0.5W 5322 100 10118 |
| R 3209 | POTM, TRIMMING    | 22K   | 20 | 0.5W 5322 100 10118 |
| R 3211 | POTM, TRIMMING    | 10K   | 20 | 0.5W 5322 101 14066 |
| R 3212 | RESISTOR, M. FILM | 5,62K | 1  | MR25 4822 116 51281 |
| R 3213 | RESISTOR, M. FILM | 5,62K | 1  | MR25 4822 116 51281 |
| R 3214 | RESISTOR, M. FILM | 5,62K | 1  | MR25 4822 116 51281 |
| R 3216 | RESISTOR, M. FILM | 5,62K | 1  | MR25 4822 116 51281 |
| R 3217 | RESISTOR, M. FILM | 5,62K | 1  | MR25 4822 116 51281 |
| R 3218 | RESISTOR, M. FILM | 5,62K | 1  | MR25 4822 116 51281 |
| R 3219 | POTM, TRIMMING    | 10K   | 20 | 0.5W 5322 101 14066 |
| R 3221 | POTM, TRIMMING    | 22K   | 20 | 0.5W 5322 100 10118 |
| R 3222 | POTM, TRIMMING    | 22K   | 20 | 0.5W 5322 100 10118 |
| R 3223 | RESISTOR, M. FILM | 100   | 1  | MR25 5322 116 55549 |
| R 3224 | RESISTOR, M. FILM | 82,5K | 1  | MR25 5322 116 55374 |
| R 3226 | POTM, TRIMMING    | 10K   | 20 | 0.5W 5322 101 14066 |
| R 3227 | RESISTOR, M. FILM | 14,7K | 1  | MR25 5322 116 54632 |
| R 3228 | RESISTOR, M. FILM | 6,81K | 1  | MR25 4822 116 51252 |
| R 3229 | RESISTOR, M. FILM | 6,81K | 1  | MR25 4822 116 51252 |

| POSNR  | DESCRIPTION       |       |    | ORDERING CODE       |
|--------|-------------------|-------|----|---------------------|
| R 3231 | RESISTOR, M. FILM | 14,7K | 1  | MR25 5322 116 54632 |
| R 3232 | RESISTOR, M. FILM | 31,6K | 1  | MR25 5322 116 54657 |
| R 3233 | RESISTOR, M. FILM | 42,2K | 1  | MR25 5322 116 50474 |
| R 3234 | RESISTOR, M. FILM | 31,6K | 1  | MR25 5322 116 54657 |
| R 3236 | RESISTOR, M. FILM | 31,6K | 1  | MR25 5322 116 54657 |
| R 3237 | RESISTOR, M. FILM | 3,48K | 1  | MR25 5322 116 55367 |
| R 3238 | RESISTOR, M. FILM | 42,2  | 1  | MR25 5322 116 51052 |
| R 3239 | RESISTOR, M. FILM | 8,25K | 1  | MR25 5322 116 54558 |
| R 3240 | RESISTOR, M. FILM | 1K    | 1  | MR25 4822 116 51235 |
| R 3241 | RESISTOR, M. FILM | 100   | 1  | MR25 5322 116 55549 |
| R 3242 | RESISTOR, M. FILM | 46,4K | 1  | MR25 5322 116 50557 |
| R 3243 | RESISTOR, M. FILM | 82,5  | 1  | MR25 5322 116 54462 |
| R 3244 | RESISTOR, M. FILM | 133   | 1  | MR25 5322 116 54482 |
| R 3246 | RESISTOR, M. FILM | 82,5  | 1  | MR25 5322 116 54462 |
| R 3247 | RESISTOR, M. FILM | 133   | 1  | MR25 5322 116 54482 |
| R 3248 | RESISTOR, M. FILM | 316   | 1  | MR25 5322 116 54511 |
| R 3249 | RESISTOR, M. FILM | 316   | 1  | MR25 5322 116 54511 |
| R 3251 | RESISTOR, M. FILM | 316   | 1  | MR25 5322 116 54511 |
| R 3252 | RESISTOR, M. FILM | 316   | 1  | MR25 5322 116 54511 |
| R 3253 | RESISTOR, M. FILM | 2,87K | 1  | MR25 5322 116 50414 |
| X 3254 | RESISTOR, M. FILM | 2,87K | 1  | MR25 5322 116 50414 |
| R 3256 | RESISTOR, M. FILM | 2,87K | 1  | MR25 5322 116 50414 |
| R 3257 | RESISTOR, M. FILM | 3,48K | 1  | MR25 5322 116 55367 |
| R 3258 | RESISTOR, M. FILM | 28,7K | 1  | MR25 5322 116 54653 |
| R 3259 | RESISTOR, M. FILM | 316   | 1  | MR25 5322 116 54511 |
| R 3260 | RESISTOR, M. FILM | 8,25K | 1  | MR25 5322 116 54558 |
| R 3261 | RESISTOR, M. FILM | 316   | 1  | MR25 5322 116 54511 |
| R 3262 | RESISTOR, M. FILM | 6,81K | 1  | MR25 4822 116 51252 |
| R 3263 | RESISTOR, M. FILM | 6,81K | 1  | MR25 4822 116 51252 |
| R 3264 | RESISTOR, M. FILM | 316   | 1  | MR25 5322 116 54511 |
| R 3266 | RESISTOR, M. FILM | 2,87K | 1  | MR25 5322 116 50414 |
| R 3267 | RESISTOR, M. FILM | 2,87K | 1  | MR25 5322 116 50414 |
| R 3268 | RESISTOR, M. FILM | 316   | 1  | MR25 5322 116 54511 |
| R 3269 | RESISTOR, M. FILM | 2,87K | 1  | MR25 5322 116 50414 |
| R 3271 | RESISTOR, M. FILM | 2,87K | 1  | MR25 5322 116 50414 |
| R 3272 | RESISTOR, M. FILM | 2,37K | 1  | MR25 5322 116 54576 |
| R 3273 | POTM, TRIMMING    | 10K   | 20 | 0.5W 5322 101 14066 |
| R 3274 | RESISTOR, M. FILM | 100   | 1  | MR25 5322 116 55549 |
| R 3276 | RESISTOR, M. FILM | 215   | 1  | MR25 5322 116 55274 |
| R 3277 | RESISTOR, M. FILM | 4,64K | 1  | MR25 5322 116 50484 |
| R 3278 | RESISTOR, M. FILM | 8,25K | 1  | MR25 5322 116 54558 |
| R 3279 | RESISTOR, M. FILM | 1K    | 1  | MR25 4822 116 51235 |
| R 3281 | RESISTOR, M. FILM | 316   | 1  | MR25 5322 116 54511 |
| R 3282 | RESISTOR, M. FILM | 316   | 1  | MR25 5322 116 54511 |
| R 3283 | RESISTOR, M. FILM | 2,87K | 1  | MR25 5322 116 50414 |
| R 3284 | RESISTOR, M. FILM | 316   | 1  | MR25 5322 116 54511 |
| R 3286 | RESISTOR, M. FILM | 316   | 1  | MR25 5322 116 54511 |
| R 3287 | RESISTOR, M. FILM | 59K   | 1  | MR25 5322 116 54678 |
| R 3288 | RESISTOR, M. FILM | 56,2  | 1  | MR25 5322 116 54446 |
| R 3289 | RESISTOR, M. FILM | 56,2  | 1  | MR25 5322 116 54446 |
| R 3291 | RESISTOR, M. FILM | 8,25K | 1  | MR25 5322 116 54558 |
| R 3292 | RESISTOR, M. FILM | 8,25K | 1  | MR25 5322 116 54558 |
| R 3293 | RESISTOR, M. FILM | 1,33K | 1  | MR25 5322 116 55422 |
| R 3294 | RESISTOR, M. FILM | 1,33K | 1  | MR25 5322 116 55422 |
| R 3295 | RESISTOR, M. FILM | 56,2  | 1  | MR25 5322 116 54446 |
| R 3296 | RESISTOR, M. FILM | 56,2  | 1  | MR25 5322 116 54446 |
| R 3297 | RESISTOR, M. FILM | 1K    | 1  | MR25 4822 116 51235 |
| R 3298 | RESISTOR, M. FILM | 8,25K | 1  | MR25 5322 116 54558 |
| R 3299 | RESISTOR, M. FILM | 14,7K | 1  | MR25 5322 116 54632 |
| R 3300 | RESISTOR, M. FILM | 82,5  | 1  | MR25 5322 116 54462 |
| R 3301 | RESISTOR, M. FILM | 1K    | 1  | MR25 4822 116 51235 |
| R 3302 | RESISTOR, M. FILM | 14,7K | 1  | MR25 5322 116 54632 |
| R 3303 | RESISTOR, M. FILM | 4,64K | 1  | MR25 5322 116 50484 |
| R 3304 | RESISTOR, M. FILM | 8,25K | 1  | MR25 5322 116 54558 |
| R 3305 | RESISTOR, M. FILM | 56,2  | 1  | MR25 5322 116 54446 |



| POSNR  | DESCRIPTION             | ORDERING CODE          |
|--------|-------------------------|------------------------|
| R 3306 | RESISTOR, M. FILM 1K    | MR25 4822 116 51235    |
| R 3307 | RESISTOR, M. FILM 2,87K | MR25 5322 116 50414    |
| R 3308 | RESISTOR, M. FILM 316   | MR25 5322 116 54511    |
| R 3309 | RESISTOR, M. FILM 316   | MR25 5322 116 54511    |
| R 3310 | RESISTOR, M. FILM 1K    | MR25 4822 116 51235    |
| R 3311 | RESISTOR, M. FILM 316   | MR25 5322 116 54511    |
| R 3312 | RESISTOR, M. FILM 2,87K | MR25 5322 116 50414    |
| R 3313 | RESISTOR, M. FILM 2,87K | MR25 5322 116 50414    |
| R 3314 | RESISTOR, M. FILM 2,87K | MR25 5322 116 50414    |
| R 3315 | RESISTOR, M. FILM 61.9  | MR25 5322 116 54451    |
| R 3316 | RESISTOR, M. FILM 9,09K | MR25 4822 116 51284    |
| R 3317 | RESISTOR, M. FILM 215   | MR25 5322 116 55274    |
| R 3318 | RESISTOR, M. FILM 1,1K  | MR25 4822 116 51236    |
| R 3401 | RESISTOR, M. FILM 51,1  | MR25 5322 116 54442    |
| R 3402 | RESISTOR, M. FILM 316   | MR25 5322 116 54511    |
| R 3403 | RESISTOR, M. FILM 316   | MR25 5322 116 54511    |
| R 3404 | RESISTOR, M. FILM 133   | MR25 5322 116 54482    |
| R 3406 | RESISTOR, M. FILM 82.5  | MR25 5322 116 54462    |
| R 3409 | RESISTOR, M. FILM 196   | MR25 5322 116 55273    |
| R 3411 | RESISTOR, M. FILM 196   | MR25 5322 116 55273    |
| R 3412 | RESISTOR, M. FILM 51,1  | MR25 5322 116 54442    |
| R 3413 | RESISTOR, M. FILM 133   | MR25 5322 116 54482    |
| R 3414 | RESISTOR, M. FILM 82,5  | MR25 5322 116 54462    |
| R 3416 | RESISTOR, M. FILM 196   | MR25 5322 116 55273    |
| R 3417 | RESISTOR, M. FILM 215   | MR25 5322 116 55274    |
| R 3418 | RESISTOR, M. FILM 10    | MR25 5322 116 50452    |
| R 3419 | RESISTOR, M. FILM 215   | MR25 5322 116 55274    |
| R 3421 | RESISTOR, M. FILM 51,1  | MR25 5322 116 54442    |
| R 3422 | RESISTOR, M. FILM 619   | MR25 4822 116 51232    |
| R 3423 | RESISTOR, M. FILM 1K    | MR25 4822 116 51235    |
| R 3426 | RESISTOR, M. FILM 422   | MR25 5322 116 50459    |
| R 3427 | RESISTOR, M. FILM 10K   | MR25 4822 116 51253    |
| R 3428 | RESISTOR, M. FILM 2,61K | MR25 5322 116 50671    |
| R 3429 | RESISTOR, M. FILM 196   | MR25 5322 116 55273    |
| R 3431 | RESISTOR, M. FILM 215   | MR25 5322 116 55274    |
| R 3432 | RESISTOR, M. FILM 6,19K | MR25 5322 116 55426    |
| R 3433 | RESISTOR, M. FILM 6,19K | MR25 5322 116 55426    |
| R 3434 | RESISTOR, M. FILM 2,15K | MR25 5322 116 50767    |
| R 3436 | RESISTOR, M. FILM 2,15K | MR25 5322 116 50767    |
| R 3437 | RESISTOR, M. FILM 51,1  | MR25 5322 116 54442    |
| R 3438 | RESISTOR, M. FILM 51,1  | MR25 5322 116 54442    |
| R 3435 | RESISTOR, M. FILM 4,64K | MR25 5322 116 50484    |
| R 3441 | RESISTOR, M. FILM 196   | MR25 5322 116 55273    |
| R 3442 | RESISTOR, M. FILM 196   | MR25 5322 116 55273    |
| R 4    | POTM, CARB+SW. 47K      | 20 0.1W 5322 101 64031 |
| R 401  | RESISTOR, M. FILM 6,19K | MR25 5322 116 55426    |
| R 402  | RESISTOR, M. FILM 6,19K | MR25 5322 116 55426    |
| R 403  | RESISTOR, M. FILM 15,4K | MR25 5322 116 55459    |
| R 404  | RESISTOR, M. FILM 30,1K | MR25 5322 116 54655    |
| R 406  | RESISTOR, M. FILM 6,19K | MR25 5322 116 55426    |
| R 407  | RESISTOR, M. FILM 6,19K | MR25 5322 116 55426    |
| R 408  | RESISTOR, M. FILM 301K  | MR25 5322 116 54743    |
| R 409  | RESISTOR, M. FILM 6,19K | MR25 5322 116 55426    |
| R 411  | RESISTOR, M. FILM 6,19K | MR25 5322 116 55426    |
| R 412  | RESISTOR, M. FILM 6,19K | MR25 5322 116 55426    |
| R 413  | RESISTOR, M. FILM 301K  | MR25 5322 116 54743    |
| R 414  | RESISTOR, M. FILM 15,4K | MR25 5322 116 55459    |
| R 416  | RESISTOR, M. FILM 6,19K | MR25 5322 116 55426    |
| R 417  | RESISTOR, M. FILM 6,19K | MR25 5322 116 55426    |
| R 418  | RESISTOR, M. FILM 105K  | MR25 5322 116 54698    |
| R 419  | RESISTOR, M. FILM 6,19K | MR25 5322 116 55426    |
| R 421  | RESISTOR, M. FILM 301K  | MR25 5322 116 54743    |
| R 422  | RESISTOR, M. FILM 2,26K | MR25 5322 116 50675    |
| R 423  | RESISTOR, M. FILM 2,26K | MR25 5322 116 50675    |
| R 5    | POTM, CARB+SW. 47K      | 20 0.1W 5322 101 64031 |

| POSNR  | DESCRIPTION                 | ORDERING CODE           |
|--------|-----------------------------|-------------------------|
| R 6    | POTM, CARB+SW. 47K          | 20 0.1W 5322 101 64031  |
| R 601  | RESISTOR, M. FILM 2,26K     | MR25 5322 116 50675     |
| R 602  | RESISTOR, M. FILM 2,26K     | MR25 5322 116 50675     |
| R 603  | RESISTOR, M. FILM 121       | MR25 5322 116 54426     |
| R 604  | RESISTOR, M. FILM 121       | MR25 5322 116 54426     |
| R 606  | RESISTOR, M. FILM 5,11      | MR25 5322 116 54192     |
| R 607  | RESISTOR, M. FILM 5,11      | MR25 5322 116 54192     |
| R 608  | RESISTOR, M. FILM 4,02K     | MR25 5322 116 55448     |
| R 609  | RESISTOR, M. FILM 4,02K     | MR25 5322 116 55448     |
| R 7    | POTM, CARB+SW. 4,7K         | 20 0.1W 5322 101 40098  |
| R 701  | RESISTOR, M. FILM 105       | MR25 5322 116 54472     |
| R 702  | RESISTOR, M. FILM 4,02K     | MR25 5322 116 55448     |
| R 8    | POTM, CARB+SW. 4,7K         | 20 0.1W 5322 101 40098  |
| R 801  | RESISTOR, WW. 3,3K          | 2 9X0.2W 5322 111 94252 |
| R 9    | POTM, CARB+SW. 47K          | 20 0.1W 5322 101 64032  |
| R 901  | RESISTOR, M. FILM 2,26K     | MR25 5322 116 50675     |
| R 902  | RESISTOR, M. FILM 105       | MR25 5322 116 54472     |
| R 903  | RESISTOR, M. FILM 2,26K     | MR25 5322 116 50675     |
| R 904  | RESISTOR, M. FILM 2,26K     | MR25 5322 116 50675     |
| R 905  | RESISTOR, M. FILM 4,02K     | MR25 5322 116 55448     |
| R 906  | RESISTOR, M. FILM 2,26K     | MR25 5322 116 50675     |
| R 907  | RESISTOR, M. FILM 2,26K     | MR25 5322 116 50675     |
| R 908  | RESISTOR, M. FILM 2,26K     | MR25 5322 116 50675     |
| R 909  | RESISTOR, M. FILM 2,26K     | MR25 5322 116 50675     |
| R 911  | RESISTOR, M. FILM 2,26K     | MR25 5322 116 50675     |
| R 912  | RESISTOR, M. FILM 2,26K     | MR25 5322 116 50675     |
| V 1    | BOARD, PRINTED D14-292GH/39 | PH 5322 131 24086       |
| V 1101 | DIODE, REFERENCE 8ZX79-C3V2 | PH 4822 130 34382       |
| V 1102 | DIODE, REFERENCE 8ZV13      | PH 5322 130 34301       |
| V 1103 | TRANSISTOR 8F324            | PH 4822 130 41448       |
| V 1104 | DIODE, REFERENCE BZX79-C3V3 | PH 5322 130 31504       |
| V 1106 | TRANSISTOR 8C5588           | PH 4822 130 44197       |
| V 1107 | DIODE 8AW62                 | PH 4822 130 30613       |
| V 1108 | TRANSISTOR 8F199            | PH 4822 130 44154       |
| V 1109 | TRANSISTOR 8C348C           | PH 4822 130 44196       |
| V 1111 | TRANSISTOR 8C348C           | PH 4822 130 44196       |
| V 1112 | DIODE 8AW62                 | PH 4822 130 30613       |
| V 1113 | TRANSISTOR 8F199            | PH 4822 130 44154       |
| V 1114 | DIODE, REFERENCE BZX79-C9V1 | PH 4822 130 30862       |
| V 1116 | TRANSISTOR 8C5588           | PH 4822 130 44197       |
| V 1117 | TRANSISTOR                  | PH 4822 130 44154       |
| V 1118 | DIODE, REFERENCE 8ZX79-C8V2 | PH 4822 130 34382       |
| V 1201 | DIODE 8AW62                 | PH 4822 130 30613       |
| V 1301 | DIODE 8AW62                 | PH 4822 130 30613       |
| V 1302 | DIODE, REFERENCE 8ZX79-C30  | PH 4822 130 34328       |
| V 1303 | TRANSISTOR                  | PH 4822 130 40941       |



| POSNR  | DESCRIPTION                    | ORDERING CODE  |
|--------|--------------------------------|----------------|
| V 1304 | TRANSISTOR 8D435 PH            | 4822 130 40982 |
| V 1501 | TRANSISTOR 8D237 PH            | 4822 130 44235 |
| V 1502 | DIODE BY509 PH                 | 4822 130 41485 |
| V 1503 | DIODE BYX55-600 PH             | 4822 130 41602 |
| V 1504 | DIODE BYX55-600 PH             | 4822 130 41602 |
| V 1506 | DIODE BYX55-600 PH             | 4822 130 41602 |
| V 1507 | DIODE BYX55-600 PH             | 4822 130 41602 |
| V 1508 | DIODE BYX55-600 PH             | 4822 130 41602 |
| V 1509 | DIODE BYX55-600 PH             | 4822 130 41602 |
| V 1511 | DIODE BYW29-150 PH             | 5322 130 34711 |
| V 1512 | DIODE BYW29-150 PH             | 5322 130 34711 |
| V 1513 | DIODE 8AX12A PH                | 5322 130 34605 |
| V 1514 | OIOOE 8AX12A PH                | 5322 130 34605 |
| V 1516 | DIODE 8AX12A PH                | 5322 130 34605 |
| V 1517 | DIODE 8AX12A PH                | 5322 130 34605 |
| V 1518 | DIODE BYW29-150 PH             | 5322 130 34711 |
| V 1519 | DIODE BYW29-150 PH             | 5322 130 34711 |
| V 1521 | DIODE BYV96E PH                | 5322 130 34979 |
| V 1522 | DIODE BYV96E PH                | 5322 130 34979 |
| V 1523 | TRANSISTOR BC549C PH           | 4822 130 44246 |
| V 1524 | TRANSISTOR 85538 PH            | 4822 130 40968 |
| V 1526 | TRANSISTOR 85538 PH            | 4822 130 40968 |
| V 1527 | THYRISTOR 8RY39 PH             | 5322 130 40482 |
| V 1528 | DIODE 8YV96E PH                | 5322 130 34979 |
| V 1529 | DIODE 8YV96E PH                | 5322 130 34979 |
| V 1531 | TRANSISTOR BC549C PH           | 4822 130 44246 |
| V 1532 | THYRISTOR 85568 PH             | 5322 130 44247 |
| V 1533 | THYRISTOR 85568 PH             | 5322 130 44247 |
| V 1534 | DIODE, REFERENCE BZX79-C4V7 PH | 4822 130 34174 |
| V 1536 | TRANSISTOR 85538 PH            | 4822 130 40968 |
| V 1537 | TRANSISTOR 85538 PH            | 4822 130 40968 |
| V 1538 | TRANSISTOR BC559B PH           | 4822 130 44358 |
| V 1539 | TRANSISTOR BC549C PH           | 4822 130 44246 |
| V 1541 | TRANSISTOR BC549C PH           | 4822 130 44246 |
| V 1542 | DIODE, REFERENCE BZX75-C1V4 PH | 4822 130 34047 |
| V 1543 | DIODE 8AW62 PH                 | 4822 130 30613 |
| V 1544 | DIODE, REFERENCE 1N823 PH      | 5322 130 34405 |
| V 1546 | DIODE 8AW62 PH                 | 4822 130 30613 |
| V 1547 | TRANSISTOR BC549C PH           | 4822 130 44246 |
| V 1548 | DIODE BYW29-150 PH             | 5322 130 34711 |
| V 1549 | TRANSISTOR 8D237 PH            | 4822 130 44235 |
| V 1551 | THYRISTOR 8T151-500R PH        | 5322 130 24081 |
| V 1552 | DIODE 8AW62 PH                 | 4822 130 30613 |
| V 1553 | TRANSISTOR BC549C PH           | 4822 130 44246 |
| V 1554 | DIODE, REFERENCE BZX79-C47 PH  | 4822 130 34383 |
| V 1556 | DIODE, REFERENCE BZX79-C47 PH  | 4822 130 34383 |
| V 1557 | DIODE BYW29-150 PH             | 5322 130 34711 |
| V 1558 | TRANSISTOR BC559B PH           | 4822 130 44358 |
| V 1559 | TRANSISTOR BC549C PH           | 4822 130 44246 |
| V 1561 | TRANSISTOR 8D237 PH            | 4822 130 44235 |
| V 1562 | DIODE BYW29-150 PH             | 5322 130 34711 |
| V 1563 | DIODE BYW29-150 PH             | 5322 130 34711 |
| V 1564 | TRANSISTDR BC549C PH           | 4822 130 44246 |
| V 1601 | DIODE BYV96E PH                | 5322 130 34979 |
| V 1602 | DIODE BY224-600 PH             | 5322 130 34761 |
| V 1603 | DIODE 8AX12A PH                | 5322 130 34605 |
| V 1604 | DIODE 8AX12A PH                | 5322 130 34605 |
| V 1606 | DIODE 8AX12A PH                | 5322 130 34605 |
| V 1607 | DIODE 8AX12A PH                | 5322 130 34605 |
| V 1608 | OIOOE BYV96E PH                | 5322 130 34979 |
| V 1609 | DIODE BYV96E PH                | 5322 130 34979 |
| V 1611 | DIODE, REFERENCE BZX79-C12 PH  | 4822 130 34197 |
| V 1612 | DIODE, REFERENCE BZX79-C12 PH  | 4822 130 34197 |
| V 1613 | DIODE, REFERENCE BZX79-C12 PH  | 4822 130 34197 |
| V 1614 | DIODE 8AW62 PH                 | 4822 130 30613 |

| POSNR  | DESCRIPTION                    | ORDERING CODE  |
|--------|--------------------------------|----------------|
| V 1616 | TRANSISTOR BC547B PH           | 4822 130 40959 |
| V 1617 | DIODE 8AX12A PH                | 5322 130 30613 |
| V 1618 | TRANSISTOR BUY89 PH            | 4822 130 41485 |
| V 1619 | DIODE 8AW62 PH                 | 5322 130 30613 |
| V 1621 | TRANSISTOR 8UX86 PH            | 5322 130 44718 |
| V 1622 | TRANSISTOR BC549C PH           | 4822 130 44246 |
| V 2001 | TRANSISTOR BC5478 PH           | 4822 130 40959 |
| V 2002 | DIODE HSCH-1001 PH             | 4822 130 31689 |
| V 2003 | DIODE HSCH-1001 PH             | 4822 130 31689 |
| V 2004 | DIODE 8AW62 PH                 | 4822 130 30613 |
| V 2006 | TRANSISTOR BC556 PH            | 4822 130 40989 |
| V 2007 | TRANSISTOR BF423 PH            | 4822 130 41646 |
| V 2008 | OIOOE HSCH-1001 PH             | 4822 130 31689 |
| V 2009 | DIODE HSCH-1001 PH             | 4822 130 31689 |
| V 2011 | DIODE 8AW62 PH                 | 4822 130 30613 |
| V 2012 | DIODE 8AW62 PH                 | 4822 130 30613 |
| V 2013 | TRANSISTOR BC556 PH            | 4822 130 40989 |
| V 2014 | DIODE 8AV21 PH                 | 4822 130 30842 |
| V 2016 | TRANSISTOR BF422 PH            | 4822 130 41782 |
| V 2017 | DIODE, REFERENCE BZX79-B6V2 PH | 4822 130 34167 |
| V 2018 | DIODE, REFERENCE BZX79-C10 PH  | 4822 130 34297 |
| V 2019 | DIODE 8AW62 PH                 | 4822 130 30613 |
| V 2021 | TRANSISTOR BC5478 PH           | 4822 130 40959 |
| V 2022 | DIODE, REFERENCE BZX79-B6V2 PH | 4822 130 34167 |
| V 2023 | TRANSISTOR BF422 PH            | 4822 130 41782 |
| V 2024 | DIODE 8AW62 PH                 | 4822 130 30613 |
| V 2026 | DIODE, REFERENCE BZX79-C10 PH  | 4822 130 34297 |
| V 2027 | DIODE 8AW62 PH                 | 4822 130 30613 |
| V 2028 | TRANSISTOR BC549C PH           | 4822 130 44246 |
| V 2029 | DIODE, REFERENCE BZX79-B6V8 PH | 4822 130 34278 |
| V 2031 | DIODE 8AV21 PH                 | 4822 130 30842 |
| V 2032 | TRANSISTOR BF423 PH            | 4822 130 41646 |
| V 2033 | TRANSISTOR BC549C PH           | 4822 130 44246 |
| V 2034 | TRANSISTOR BC549C PH           | 4822 130 44246 |
| V 2036 | DIODE, REFERENCE BZX79-1 PH    | 4822 130 34278 |
| V 2037 | DIODE, REFERENCE BZX79-C6V8 PH | 4822 130 34278 |
| V 2038 | TRANSISTOR BC549C PH           | 4822 130 44246 |
| V 2039 | DIODE, REFERENCE BZX79-C6V8 PH | 4822 130 34278 |
| V 2041 | DIODE, REFERENCE BZX79-C6V8 PH | 4822 130 34278 |
| V 2042 | DIODE, REFERENCE BZX79-C6V8 PH | 4822 130 34278 |
| V 2043 | DIODE, REFERENCE BZX79-C6V8 PH | 4822 130 34278 |
| V 2400 | DIODE, REFERENCE 8AW62 PH      | 4822 130 30613 |
| V 2401 | DIODE 8AW62 PH                 | 5322 130 34044 |
| V 2402 | DIODE 8AW62 PH                 | 4822 130 30613 |
| V 2403 | DIODE 8AW62 PH                 | 4822 130 30613 |
| V 2404 | DIODE 8AW62 PH                 | 4822 130 30613 |
| V 2405 | DIODE 8AW62 PH                 | 4822 130 30613 |
| V 2406 | TRANSISTOR BFW30 PH            | 5322 130 40379 |
| V 2407 | TRANSISTOR, FET BC264A PH      | 5322 130 44476 |
| V 2408 | TRANSISTOR BC549C PH           | 4822 130 44246 |
| V 2409 | DIODE 8AW62 PH                 | 4822 130 30613 |
| V 241  | DIODE, REFERENCE BZX79-C5V1 PH | 4822 130 34233 |
| V 2410 | DIODE 8AW62 PH                 | 4822 130 30613 |
| V 2411 | DIODE 8AW62 PH                 | 4822 130 30613 |
| V 2412 | DIODE 8AV45 PH                 | 5322 130 34037 |
| V 2413 | TRANSISTOR BC549C PH           | 4822 130 44246 |
| V 2414 | TRANSISTOR BC559B PH           | 4822 130 44358 |
| V 2415 | TRANSISTOR BC549C PH           | 4822 130 44246 |
| V 2416 | TRANSISTOR BC559B PH           | 4822 130 44358 |
| V 2417 | TRANSISTOR BC559B PH           | 4822 130 44358 |
| V 2418 | TRANSISTDR BF324 PH            | 4822 130 41448 |
| V 2419 | TRANSISTOR BF324 PH            | 4822 130 41448 |
| V 242  | DIODE, REFERENCE BZX79-C5V1 PH | 4822 130 34233 |
| V 2420 | TRANSISTOR BC549C PH           | 4822 130 44246 |
| V 2421 | DIODE 8AW62 PH                 | 4822 130 30613 |

| POSNR  | DESCRIPTION      |            |    | ORDERING CODE  |
|--------|------------------|------------|----|----------------|
| V 2422 | TRANSISTOR       | BC549C     | PH | 4822 130 44246 |
| V 2423 | DIODE            | BAW62      | PH | 4822 130 30613 |
| V 2424 | TRANSISTOR       | BF324      | PH | 4822 130 41448 |
| V 2426 | TRANSISTOR       | BF324      | PH | 4822 130 41448 |
| V 2427 | DIODE            | BAW62      | PH | 4822 130 30613 |
| V 2428 | TRANSISTOR       | BC559B     | PH | 4822 130 44358 |
| V 2429 | TRANSISTOR       | BC549C     | PH | 4822 130 44246 |
| V 2432 | TRANSISTOR       | BC549C     | PH | 4822 130 44246 |
| V 2432 | TRANSISTOR       | BC549C     | PH | 4822 130 44246 |
| V 2433 | TRANSISTOR       | BC559B     | PH | 4822 130 44358 |
| V 2434 | DIODE, REFERENCE | BZX75-C1V4 | PH | 4822 130 34047 |
| V 2436 | TRANSISTOR       | BC549C     | PH | 4822 130 44246 |
| V 2437 | DIODE            | BAW62      | PH | 4822 130 30613 |
| V 2438 | TRANSISTOR       | BC549C     | PH | 4822 130 44246 |
| V 2439 | TRANSISTOR       | BC549C     | PH | 4822 130 44246 |
| V 2441 | TRANSISTOR       | BC549C     | PH | 4822 130 44246 |
| V 2442 | TRANSISTOR       | BC549C     | PH | 4822 130 44246 |
| V 2443 | TRANSISTOR       | BC549C     | PH | 4822 130 44246 |
| V 2444 | TRANSISTOR       | BC559B     | PH | 4822 130 44358 |
| V 2446 | DIODE            | BAW62      | PH | 4822 130 30613 |
| V 2448 | TRANSISTOR       | BF430      | PH | 5322 130 40379 |
| V 2449 | TRANSISTOR       | BC559B     | PH | 4822 130 44358 |
| V 2450 | TRANSISTOR       | BC549C     | PH | 4822 130 44246 |
| V 2451 | TRANSISTOR, FET  | BC264A     | PH | 5322 130 44476 |
| V 2452 | DIODE            | BAW62      | PH | 4822 130 30613 |
| V 2453 | DIODE            | BAW62      | PH | 4822 130 30613 |
| V 2454 | DIODE            | BAW45      | PH | 5322 130 34037 |
| V 2456 | TRANSISTOR       | BC559B     | PH | 4822 130 44358 |
| V 2457 | TRANSISTOR       | BC559B     | PH | 4822 130 44358 |
| V 2458 | DIODE            | BAW62      | PH | 4822 130 30613 |
| V 2459 | TRANSISTOR       | BC559B     | PH | 4822 130 44358 |
| V 2461 | DIODE            | BAW62      | PH | 4822 130 30613 |
| V 2462 | TRANSISTOR       | BF324      | PH | 4822 130 41448 |
| V 2463 | DIODE            | BAW62      | PH | 4822 130 30613 |
| V 2464 | TRANSISTOR       | BC549C     | PH | 4822 130 44246 |
| V 2466 | TRANSISTOR       | BF324      | PH | 4822 130 41448 |
| V 2467 | DIODE            | BAW62      | PH | 4822 130 30613 |
| V 2468 | TRANSISTOR       | BC559B     | PH | 4822 130 44358 |
| V 2469 | TRANSISTOR       | BC549C     | PH | 4822 130 44246 |
| V 2471 | TRANSISTOR       | BC549C     | PH | 4822 130 44246 |
| V 2473 | TRANSISTOR       | BC549C     | PH | 4822 130 44246 |
| V 2474 | TRANSISTOR       | BC559B     | PH | 4822 130 44358 |
| V 2476 | TRANSISTOR       | BC549C     | PH | 4822 130 44246 |
| V 2477 | DIODE            | BAW62      | PH | 4822 130 30613 |
| V 2478 | DIODE, REFERENCE | BZX75-C2V1 | PH | 4822 130 34049 |
| V 2479 | DIODE, REFERENCE | BZX75-C2V8 | PH | 4822 130 34048 |
| V 2480 | DIODE, REFERENCE | BZX79-C9V1 | PH | 4822 130 30862 |
| V 2481 | DIODE            | BAW62      | PH | 4822 130 30613 |
| V 2483 | DIODE            | BAW62      | PH | 4822 130 30613 |
| V 2484 | DIODE            | BAW62      | PH | 4822 130 30613 |
| V 2485 | DIODE, REFERENCE | BZX75-C1V4 | PH | 4822 130 34047 |
| V 2486 | DIODE            | BAW62      | PH | 4822 130 30613 |
| V 2487 | DIODE            | BAW62      | PH | 4822 130 30613 |
| V 2701 | TRANSISTOR, FET  | BC264A     | PH | 5322 130 44476 |
| V 2702 | TRANSISTOR       | BFY90      | PH | 4822 130 40493 |
| V 2703 | TRANSISTOR       | BC559B     | PH | 4822 130 44358 |
| V 2704 | DIODE            | BAW62      | PH | 4822 130 30613 |
| V 2706 | DIODE            | BAW62      | PH | 4822 130 30613 |
| V 2707 | TRANSISTOR       | BF324      | PH | 4822 130 41448 |
| V 2708 | TRANSISTOR       | BC549C     | PH | 4822 130 44246 |
| V 2709 | DIODE            | BAW62      | PH | 4822 130 30613 |
| V 2711 | TRANSISTOR       | BF324      | PH | 4822 130 41448 |
| V 2712 | TRANSISTOR       | BC549C     | PH | 4822 130 44246 |
| V 2713 | DIODE            | BAW62      | PH | 4822 130 30613 |
| V 2714 | DIODE            | BAW62      | PH | 4822 130 30613 |
| V 2716 | DIODE            | BAW62      | PH | 4822 130 30613 |

| POSNR  | DESCRIPTION      |            |    | ORDERING CODE  |
|--------|------------------|------------|----|----------------|
| V 2717 | TRANSISTOR       | BC549C     | PH | 4822 130 44246 |
| V 2718 | TRANSISTOR       | BC549C     | PH | 4822 130 44246 |
| V 2719 | DIODE            | BAW62      | PH | 4822 130 30613 |
| V 2722 | DIODE            | BAW62      | PH | 4822 130 30613 |
| V 2723 | TRANSISTOR       | BC559B     | PH | 4822 130 44358 |
| V 2724 | TRANSISTOR       | BC549C     | PH | 4822 130 44246 |
| V 2726 | TRANSISTOR       | BF199      | PH | 4822 130 44154 |
| V 2727 | TRANSISTOR       | BC549C     | PH | 4822 130 44246 |
| V 2728 | TRANSISTOR       | BC559B     | PH | 4822 130 44358 |
| V 2729 | TRANSISTOR       | BC549C     | PH | 4822 130 44246 |
| V 2731 | TRANSISTOR       | BF199      | PH | 4822 130 44154 |
| V 2732 | TRANSISTOR       | BC549C     | PH | 4822 130 44246 |
| V 2733 | TRANSISTOR       | BF450      | PH | 4822 130 44237 |
| V 2734 | DIODE            | BAW62      | PH | 4822 130 30613 |
| V 2736 | TRANSISTOR       | BC549C     | PH | 4822 130 44246 |
| V 2737 | TRANSISTOR       | BC549C     | PH | 4822 130 44246 |
| V 2738 | DIODE            | BAW62      | PH | 4822 130 30613 |
| V 2739 | DIODE            | BAW62      | PH | 4822 130 30613 |
| V 2741 | TRANSISTOR       | BC549C     | PH | 4822 130 44246 |
| V 2742 | TRANSISTOR       | BC549C     | PH | 4822 130 44246 |
| V 2743 | DIODE            | BAW62      | PH | 4822 130 30613 |
| V 2744 | DIODE            | BAW62      | PH | 4822 130 30613 |
| V 2746 | TRANSISTOR       | BC549C     | PH | 4822 130 44246 |
| V 2747 | TRANSISTOR       | BC549C     | PH | 4822 130 44246 |
| V 2748 | DIODE            | BAW62      | PH | 4822 130 30613 |
| V 2749 | TRANSISTOR       | BF450      | PH | 4822 130 44237 |
| V 2751 | TRANSISTOR       | BC549C     | PH | 4822 130 44246 |
| V 2752 | DIODE, REFERENCE | BZX75-C2V1 | PH | 4822 130 34049 |
| V 2753 | TRANSISTOR       | BC559B     | PH | 4822 130 44358 |
| V 2754 | TRANSISTOR       | BC559B     | PH | 4822 130 44358 |
| V 2756 | TRANSISTOR       | BF324      | PH | 4822 130 41448 |
| V 2757 | TRANSISTOR       | BF324      | PH | 4822 130 41448 |
| V 2758 | TRANSISTOR       | BF324      | PH | 4822 130 41448 |
| V 2759 | TRANSISTOR       | BF324      | PH | 4822 130 41448 |
| V 2761 | TRANSISTOR       | BF450      | PH | 4822 130 44237 |
| V 2762 | TRANSISTOR       | BC549C     | PH | 4822 130 44246 |
| V 2763 | TRANSISTOR       | BC549C     | PH | 4822 130 44246 |
| V 2764 | TRANSISTOR       | BC559B     | PH | 4822 130 44358 |
| V 2901 | DIODE            | BAW62      | PH | 4822 130 30613 |
| V 2902 | DIODE            | BAW62      | PH | 4822 130 30613 |
| V 2903 | DIODE, REFERENCE | BZV10      | PH | 5322 130 34439 |
| V 2904 | DIODE            | BAW62      | PH | 4822 130 30613 |
| V 2905 | DIODE, REFERENCE | BZX75-C1V4 | PH | 4822 130 34047 |
| V 2906 | DIODE            | BAW62      | PH | 4822 130 30613 |
| V 2907 | DIODE            | BAW62      | PH | 4822 130 30613 |
| V 2908 | TRANSISTOR       | BC559B     | PH | 4822 130 44358 |
| V 2909 | DIODE            | BAW62      | PH | 4822 130 30613 |
| V 2911 | DIODE            | BAW62      | PH | 4822 130 30613 |
| V 2912 | DIODE            | BAW62      | PH | 4822 130 30613 |
| V 2913 | TRANSISTOR       | BSX20      | PH | 4822 130 41705 |
| V 2914 | DIODE            | BAW62      | PH | 4822 130 30613 |
| V 2915 | DIODE, REFERENCE | BZX75-C1V4 | PH | 4822 130 34047 |
| V 2916 | TRANSISTOR       | BSX20      | PH | 4822 130 41705 |
| V 2917 | TRANSISTOR       | BC559B     | PH | 4822 130 44358 |
| V 2918 | TRANSISTOR       | BC559B     | PH | 4822 130 44358 |
| V 2919 | DIODE            | BAW62      | PH | 4822 130 30613 |
| V 2920 | DIODE            | BAW62      | PH | 4822 130 30613 |
| V 2921 | DIODE, REFERENCE | BZV10      | PH | 5322 130 34439 |
| V 2922 | TRANSISTOR       | BC559B     | PH | 4822 130 44358 |
| V 3001 | TRANSISTOR       | BFQ24      | PH | 5322 130 41664 |
| V 3002 | TRANSISTOR       | BFQ24      | PH | 5322 130 41664 |
| V 3003 | TRANSISTOR       | BC549C     | PH | 4822 130 44246 |
| V 3004 | TRANSISTOR       | BC549C     | PH | 4822 130 44246 |
| V 3006 | TRANSISTOR       | BC559B     | PH | 4822 130 44358 |

| POSNR  | DESCRIPTION                    | ORDERING CODE  |
|--------|--------------------------------|----------------|
| V 3007 | TRANSISTOR BC559B PH           | 4822 130 44358 |
| V 3008 | TRANSISTOR BC559B PH           | 4822 130 44358 |
| V 3009 | TRANSISTOR BC549C PH           | 4822 130 44246 |
| V 3010 | DIODE, REFERENCE BZX79-C5V6 PH | 4822 130 34173 |
| V 3011 | DIODE, REFERENCE BZV13 PH      | 5322 130 34301 |
| V 3012 | DIODE, REFERENCE BZV13 PH      | 5322 130 34301 |
| V 3201 | TRANSISTOR BC337 PH            | 4822 130 40855 |
| V 3202 | DIODE, REFERENCE BZX79-C8V2 PH | 4822 130 34382 |
| V 3203 | DIODE, REFERENCE BZX79-C4V7 PH | 4822 130 34174 |
| V 3204 | DIODE, REFERENCE BZX79-C4V7 PH | 4822 130 34174 |
| V 3206 | DIODE, REFERENCE BZX79-C4V7 PH | 4822 130 34174 |
| V 3207 | DIODE, REFERENCE BZX79-C4V7 PH | 4822 130 34174 |
| V 3208 | DIODE, REFERENCE BZX79-C4V7 PH | 4822 130 34174 |
| V 3209 | DIODE, REFERENCE BZX79-C4V7 PH | 4822 130 34174 |
| V 3211 | TRANSISTOR BD435 PH            | 4822 130 40982 |
| V 3212 | TRANSISTOR BD436 PH            | 4822 130 40995 |
| V 3213 | TRANSISTOR BSX20 PH            | 4822 130 41705 |
| V 3214 | DIODE, REFERENCE BZV13 PH      | 5322 130 34301 |
| V 3216 | TRANSISTOR BC327 PH            | 4822 130 40854 |
| V 3217 | TRANSISTOR BC337 PH            | 4822 130 40855 |
| V 3218 | DIODE, REFERENCE BZX79-C8V2 PH | 4822 130 34382 |
| V 3219 | DIODE, REFERENCE BZX79-C8V2 PH | 4822 130 34382 |
| V 3221 | TRANSISTOR BSX20 PH            | 4822 130 41705 |
| V 3223 | DIODE, REFERENCE BZX79-C27 PH  | 4822 130 34379 |
| V 3401 | TRANSISTOR BC558B PH           | 4822 130 44197 |
| V 3402 | TRANSISTOR BC548C PH           | 4822 130 44196 |
| V 3403 | TRANSISTOR BC548C PH           | 4822 130 44196 |
| V 3404 | TRANSISTOR BC548C PH           | 4822 130 44196 |
| V 401  | DIODE BAW62 PH                 | 4822 130 30613 |
| V 402  | DIODE BAW62 PH                 | 4822 130 30613 |
| V 601  | DIODE BAW62 PH                 | 4822 130 30613 |
| V 602  | DIODE BAW62 PH                 | 4822 130 30613 |
| V 701  | DIODE BAW62 PH                 | 4822 130 30613 |
| V 901  | DIODE BAW62 PH                 | 4822 130 30613 |

1.2.2.7. Miscellaneous

| Item        | Ordering number | Type/Description     |
|-------------|-----------------|----------------------|
| B1          | 532213034875    | Led red cdy 54 - 111 |
| 32          | 5322 130 34875  | Led red cdy 54 - 111 |
| a3          | 532213034875    | Led red cdy 54 - 111 |
| 84          | 532213034875    | Led red cdy 54 - 111 |
| 85          | 532213034875    | Led red cdy 54 - 111 |
| 86          | 5322 130 34875  | Led red cdy 54 - 111 |
| 87          | 532213034875    | Led red cdy 54 - 111 |
| 88          | 5322 130 34875  | Led red cdy 54 - 111 |
| 89          | 5322 130 34875  | Led red cdy 54 - 111 |
| 810         | 5322 130 34971  | DL1414D Display      |
| 811         | 5322 130 34971  | DL1414D Display      |
| 812         | 532213034971    | DL1414D Display      |
| 813         | 4822 13440167   | Lamp 5 V 60 mA       |
| 814         | 4822 13440167   | Lamp 5 V 60 mA       |
| 815         | 5322 130 34875  | Lamp 5 V 60 mA       |
| 816         | 5322 130 34875  | Led red cdy 54 - 111 |
| 817         | 482213440167    | Lamp 5 V 60 mA       |
| 818         | 482213440167    | Lamp 5 V 60 mA       |
| 819         | 4822 13440167   | Lamp 5 V 60 mA       |
| 820         | 482213440167    | Lamp 5 V 60 mA       |
| 821         | 532213034971    | DL1414D Display      |
| 822         | 532213034875    | Led red cdy 54 - 111 |
| 823         | 532213034875    | Led red cdy 54 - 111 |
| 824         | 4822 130 31144  | Led red cdy 248      |
| 8401        | 532224274397    | CRYSTAL 5MC          |
| E1          | 5322 134 44177  | Lamp 28 V 80 mA      |
| E2          | 5322 134 44177  | Lamp 28 V 80 mA      |
| F1701       | 482225330025    | Fuse                 |
| K2401 K2418 | 532228024126    | Reed contact         |
| K2401 K2418 | 5322156 14076   | Reed coil            |
| K2701       | 5322 280 24131  | Reed relay assy      |
| L1101       | 532215810283    | Microchoke 150 μH    |
| 11102       | 5322 156 14101  | Coil                 |
| L1103       | 5322 156 14101  | Coil                 |
| L1104       | 5322 156 14101  | COIL                 |
| L1106       | 532215614101    | COIL                 |
| L1501       |                 |                      |
| L1502       |                 |                      |
| L1503       | 482215220486    | Choke AT 4043-15     |
| L1504       |                 |                      |
| L1506       | 532215224095    | Choke TFU 15         |
| L1508       |                 |                      |
| L1509       | 532215224094    | Choke TFU-15         |
| 11601       | 532228164154    | COIL                 |
| 11602       | 5322 152 24062  | Choke                |
| L1603       | 5322 156 14076  | Coil                 |
| L1604       | 532215614076    | COIL                 |
| L2401       |                 |                      |
| 12402       |                 |                      |
| 12403       | 532215614076    | COIL                 |
| L2404       |                 |                      |

| Item   | Ordering number | Type/Description      |
|--|-----------------|-----------------------|
| L2406<br>L2407<br>L2408<br>L2409<br>L2411<br>12412 | 5322 158 14283  | Coil assy             |
| S1   | 532227644099    | Pushbutton switch     |
| S8   | 5322 276 34063  | Pushbutton switch     |
| S11  | 532227634064    | Pushbutton switch     |
| S14  | 532227674026    | Pushbutton switch     |
| S20  | 532227864015    | Rotary switch         |
| S22  | 5322 278 64015  | Rotary switch         |
| S23  | 532227864015    | Rotary switch         |
| S29  | 532227644084    | Pushbutton switch     |
| S30  | 532227674037    | Pushbutton switch     |
| S37  | 5322 276 44085  | Pushbutton switch     |
| S39  | 532227644086    | Pushbutton switch     |
| S45  | 532227724071    | Mains voltage adaptor |
| S201   | 532226364007    | Plug (jumper)         |
| S1201  | 532226364007    | Plug (jumper)         |
| S1801  | 4822277 10348   | Switch assy.          |
| T1501  | 532214264104    | Transformer           |
| T1601  | 5322 148 80048  | Transformer           |
| T1602  | 532214634126    | Transformer           |
| T1603  | 532214244026    | Transformer           |
| V1   | 5322 131 24086  | C.R.T. D14-292GH/39   |
| X1   | 5322 267 14014  | CAL socket            |
| X2   | 532240594073    | CAL current loop      |
| x3   | 5322 261 10004  | HF CON BNC Female     |
| x4   | 5322267 14037   | Connector             |
| x5   | 532253584446    | Threaded end          |
| X6   | 5322267 10004   | HF CON BNC Female     |
| x7   | 532226814157    | Contact               |
| X8   | 532226814157    | Contact               |
| X259   | 532226774117    | Plug female           |
| X1606  | 482226830071    | Plug                  |
| 21701  | 5322 121 44261  | Mains filter          |

1.2.2.8. Connectors

| Ordering number | Description                                     |
|-----------------|---|
| 532226564082    | 64-pole connector male                          |
| 532226774092    | 64-pole connector female                        |
| 5322267 64001   | CIS connectors male                             |
| 532226764031    | CIS connectors bottom entry                     |
| 532226554006    | CIS connectors top entry                        |
| 532229034123    | Soldering pin for measuring points              |
| 4822 267 50268  | CIS connector male                              |
| 532226823116    | Coaxial socket, vertically mounted on pc boards |
| 482226530121    | 3-pole socket (stock MKS 823-1-0-303)           |
| 532226824133    | Delay line connectors                           |

1.2.2.9. IEC 625-1 bus interface unit A 14 (PM3325)

| Item       | Ordering number | Description                     |
|------------|-----------------|---------------------------------|
| CAPACITORS |                 |                                 |
| C 1401     | 4822 122 31414  | CAPACITOR, CERAM 10NF 100V      |
| C 1402     | 4822 122 31414  | CAPACITOR, CERAM 10NF 100V      |
| C 1403     | 4822 122 31414  | CAPACITOR, CERAM 10NF 100V      |
| C 1404     | 4822 122 31414  | CAPACITOR, CERAM 10NF 100V      |
| C 1406     | 4822 122 31414  | CAPACITOR, CERAM 10NF 100V      |
| C 1407     | 4822 122 31173  | CAPACITOR, CERAM 220PF 10% 500V |
| C 1408     | 4822 122 31414  | CAPACITOR, CERAM 10NF 100V      |
| C 1409     | 4822 122 31414  | CAPACITOR, CERAM 10NF 100V      |
| C 1411     | 4822 122 31414  | CAPACITOR, CERAM 10NF 100V      |
| C 1412     | 4822 122 31414  | CAPACITOR, CERAM 10NF 100V      |
| C 1413     | 4822 122 31416  | CAPACITOR, CERAM 10NF 100V      |
| C 1414     | 4822 122 31414  | CAPACITOR, CERAM 10NF 100V      |
| C 1416     | 4822 122 31414  | CAPACITOR, CERAM 10NF 100V      |
| C 1417     | 4822 122 31414  | CAPACITOR, CERAM 10NF 100V      |
| C 1418     | 4822 122 31054  | CAPACITOR, CERAM 10PF 2% 100V   |
| C 1419     | 4822 122 31054  | CAPACITOR, CERAM 10PF 2% 100V   |
| C 1421     | 4822 122 31054  | CAPACITOR, CERAM 10PF 2% 100V   |
| C 1422     | 4822 122 31414  | CAPACITOR, CERAM 10NF 100V      |
| C 1423     | 4822 122 31414  | CAPACITOR, CERAM 10NF 100V      |
| C 1424     | 4822 122 31414  | CAPACITOR, CERAM 10NF 100V      |
| C 1426     | 4822 122 31414  | CAPACITOR, CERAM 10NF 100V      |
| C 1427     | 4822 122 31414  | CAPACITOR, CERAM 10NF 100V      |
| C 1428     | 4822 122 31414  | CAPACITOR, CERAM 10NF 100V      |
| C 1429     | 0822 122 31414  | CAPACITOR, CERAM 10NF 100V      |
| C 1431     | 4822 122 31414  | CAPACITOR, CERAM 10NF 100V      |
| C 1432     | 4822 122 31414  | CAPACITOR, CERAM 10NF 100V      |
| C 1433     | 4822 122 31414  | CAPACITOR, CERAM 10NF 100V      |
| C 1434     | 4822 122 31414  | CAPACITOR, CERAM 10NF 100V      |
| C 1436     | 4822 122 31173  | CAPACITOR, CERAM 220PF 10% 500V |
| C 1437     | 4822 124 20699  | CAP, ELECTROLYT 47UF 50% 25V    |
| RESISTORS  |                 |                                 |
| R 1401     | 5322 116 50608  | RESISTOR, M. FILM 5K19 1% 0,4W  |
| R 1402     | 5322 116 50608  | RESISTOR, M. FILM 5K19 1% 0,4W  |
| R 1403     | 5322 116 50608  | RESISTOR, M. FILM 6K19 1% 0,4W  |
| R 1404     | 5322 116 50608  | RESISTOR, M. FILM 6K19 1% 0,4W  |

| Item                       | Ordering number | Description                |
|----------------------------|-----------------|----------------------------|
| <b>INTEGRATED CIRCUITS</b> |                 |                            |
| D 1401                     | 5322 209 84823  | INTEGR. CIRCUIT N74LS00N   |
| D 1402                     | 5322 209 84996  | INTEGR. CIRCUIT SN74LS10N  |
| D 1403                     | 5322 209 85311  | INTEGR. CIRCUIT N74LS32A   |
| D 1404                     | 5322 209 84995  | INTEGR. CIRCUIT SN74LS08N  |
| D 1406                     | 5322 209 85464  | INTEGR. CIRCUIT MC3441P    |
| D 1407                     | 5322 209 85464  | INTEGR. CIRCUIT MC3441P    |
| D 1408                     | 5322 209 14509  | INTEGR. CIRCUIT HEF4738VP  |
| D 1409                     | 5322 209 85266  | INTEGR. CIRCUIT SN74LS123N |
| D 1411                     | 5322 209 85312  | INTEGR. CIRCUIT N74LS02A   |
| D 1412                     | 5322 209 85266  | INTEGR. CIRCUIT SN74LS123N |
| D 1413                     | 5322 209 85562  | INTEGR. CIRCUIT            |
| D 1414                     | 5322 209 85752  | INTEGR. CIRCUIT N74LS155H  |
| D 1416                     | 5322 209 85464  | INTEGR. CIRCUIT MC3441P    |
| D 1417                     | 5322 209 85464  | INTEGR. CIRCUIT MC3441P    |
| D 1418                     | 5322 209 84997  | INTEGR. CIRCUIT SN74LS86N  |
| D 1419                     | 5322 209 85346  | INTEGR. CIRCUIT SN74LS279N |
| D 1421                     | 5322 209 84823  | INTEGR. CIRCUIT N74LS00N   |
| D 1422                     | 5322 209 84823  | INTEGR. CIRCUIT N74LS00N   |
| D 1423                     | 5322 209 86017  | INTEGR. CIRCUIT SN74LS244N |
| D 1424                     | 5322 209 86062  | INTEGR. CIRCUIT            |
| D 1426                     | 5322 209 86062  | INTEGR. CIRCUIT            |
| D 1427                     | 5322 209 86062  | INTEGR. CIRCUIT            |
| D 1428                     | 5322 209 86017  | INTEGR. CIRCUIT SN74LS244N |
| D 1429                     | 5322 209 14219  | INTEGR. CIRCUIT HEF4014BP  |
| D 1431                     | 5322 209 14219  | INTEGR. CIRCUIT HEF4014BP  |
| <b>MISCELLANEOUS</b>       |                 |                            |
| S 1401                     | 5322 277 24045  | SWITCH                     |
| S 1402                     | 5322 277 24045  | SWITCH                     |
| S 1403                     | 5322 277 24045  | SWITCH                     |
| S 1404                     | 5322 277 24045  | SWITCH                     |
| S 1405                     | 5322 277 24045  | SWITCH                     |
| S 1406                     | 5322 277 24045  | SWITCH                     |
| S 1407                     | 5322 277 24053  | SWITCH, SLIDE              |
| X 1401                     | 5322 265 64082  | SOCKET, MALE               |
| A80                        | 5322 321 20474  | CABLE, CONNECT.            |
| D407                       | 5322 209 10151  | INTEGR. CIRCUIT            |
|                            | 5322 500 10265  | NUT                        |

## 13. ADDITIONAL DIAGRAMS

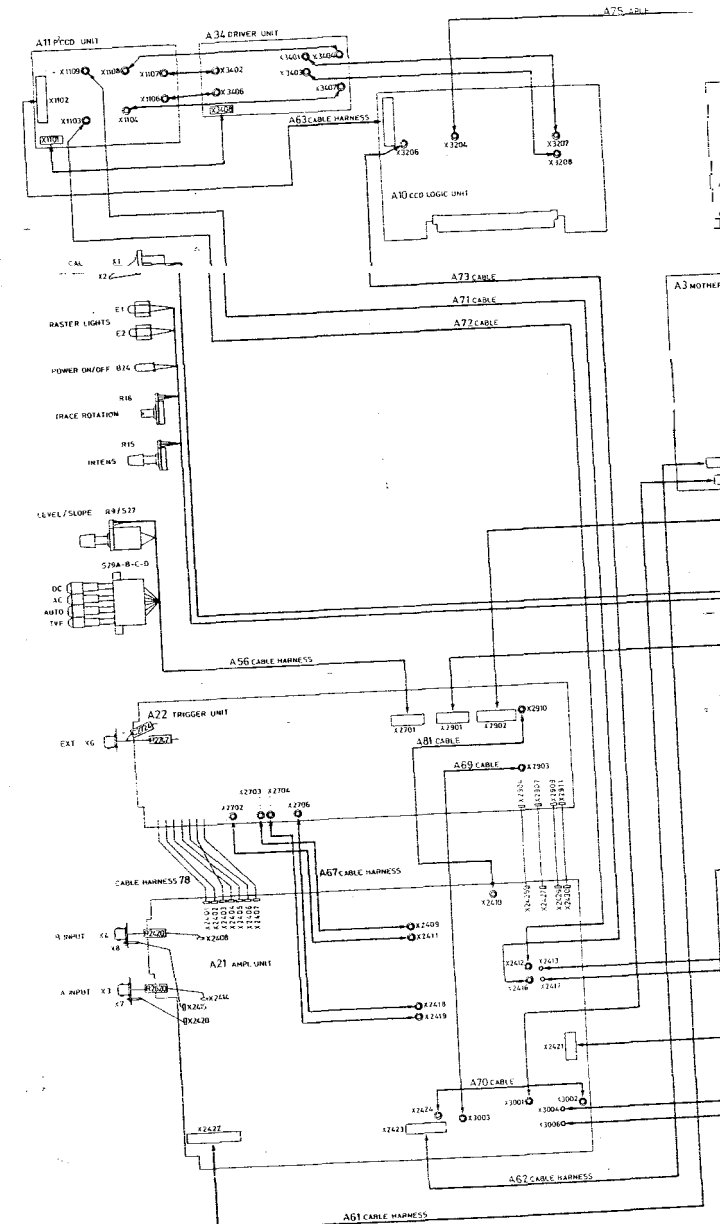

13. ADDITIONAL DIAGRAMS

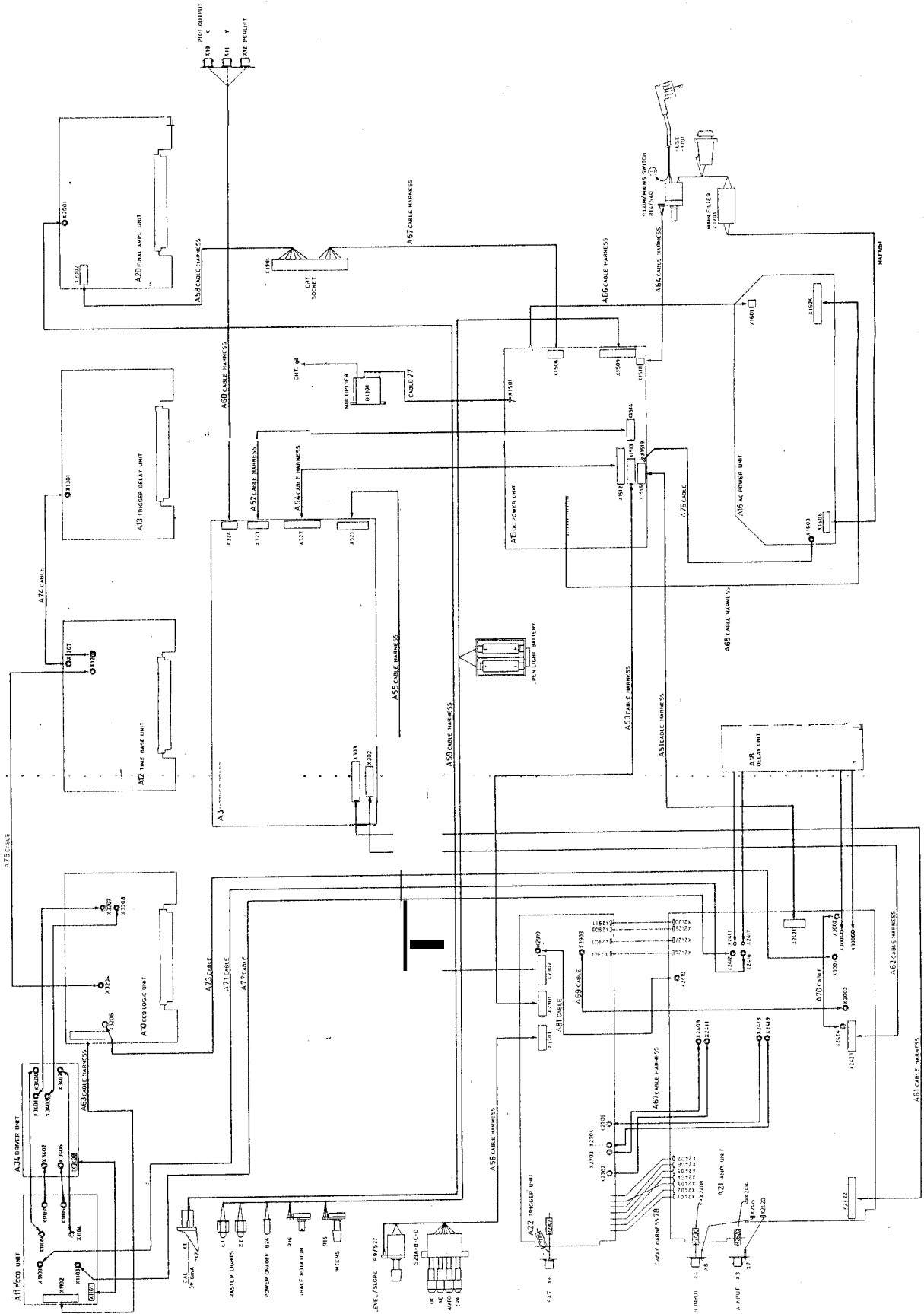

Fig. 13.1.1. Wiring diagram